



aerospace  
climate control  
electromechanical  
filtration  
fluid & gas handling  
hydraulics  
pneumatics  
process control  
sealing & shielding



# Hydraulic Hoses, Fittings and Equipment

Catalogue



ENGINEERING YOUR SUCCESS.



# Detailed table of Contents

Introduction

2 – 22

## Technical Handbook

Hoses and Fittings Terminology – The basics

Aa-2 – Aa-8

Safe Hose Assemblies in 8 Steps

Aa-9 – Aa19

How to Order (Part number description)

Aa-20 – Aa-21

Hoses and Fittings Storage

Aa-22 – Aa-23

Safety Precaution

Aa-24 – Aa-25

Proactive Maintenance Programme

Aa-26

Technical Data

Ab-2 – Ab-45

## Low Pressure Push-Lok

Push-Lok Hoses

B1a-1 – B1a-9

Fittings 82 series

B1b-1 – B1b-21

Assembly Instructions / Assembly Tools

B1b-22

## Low Pressure Transportation + Hydraulic

Hoses

B2a-1 – B2a-11

Fittings 26 series

B2b-1 – B2b-11

## Medium pressure

Parkrimp No-Skive Hoses

Ca-1 – Ca-32

Fittings 46 and 48 series

Cb-1 – Cb-48

## High pressure

Hoses

Da-1 – Da-30

Fittings 70 series

Db-1 – Db-19

Fittings 71 series

Dc-1 – Dc-16

Fittings 73 series

Dd-1 – Dd-17

Fittings 76 series

De-1

Fittings 77 series

Df-1 – Df-16

Fittings 78 series

Dg-1 – Dg-15

Fittings 79 series

Dh-1 – Dh-6

Fittings S6 series

Di-1 – Di-3

Fittings VS series

Dj-1 – Dj-16

Fittings V4/V6/VB series

Dk-1 – Dj-28

## Machines, Tooling, Accessories

Machines

Ea-1 – Ea-29

Accessories

Eb-1 – Eb-20

Assembly Instructions

Ec-1 – Ec-2

Crimp Charts

Ed-1 – Ed-13

# Parker Hannifin –

the global leader and your partner



With annual sales exceeding \$12 billion, Parker Hannifin is the world's leading diversified manufacturer of motion and control technologies and systems, providing precision-engineered solutions for a wide variety of mobile, industrial and aerospace markets. Our products are vital to virtually everything that moves or requires control, including the manufacture and processing of raw materials, durable goods, infrastructure development and all forms of transport.

Within Parker's eight operating groups, the company's engineering expertise spans the core motion technologies – electromechanical, hydraulic and pneumatic – with a full complement of fluid handling, filtration, sealing and shielding, climate control, process control and aerospace technologies. The leader in “dry technology” for the fluid power industry, Parker's Fluid Connectors Group is your single source for high-quality tube fittings, hose and hose fittings, thermoplas-

tic tubing, brass fittings and valves, quickdisconnect couplings and assembly tools. The Fluid Connectors Group serves customers in a broad range of markets, including Aerial Lift, Agriculture, Bulk Chemical Handling, Construction Machinery, Food & Beverage, Fuel & Gas Delivery, Industrial Machinery, Medical, Mining, Mobile, Oil & Gas and Transportation. Products are available for shipment 24 hours a day, supported by 49 manufacturing facilities throughout the world, a global distribution

network and 25 company-owned stocking service centers. Our commitment to you is impeccable customer service. To meet your specific requirements, we offer a broad range of programs designed to reduce your overall operating costs, streamline manufacturing, improve productivity, manage inventory, enhance delivery and address safety and environmental issues. For value-added services that generate value-added solutions, team up with Parker!

# Parker Hannifin –

opportunity through innovation in the world's most demanding markets



## Worldwide availability

With more than 50,000 employees serving over 500,000 customers in almost 50 countries, Parker is literally everywhere you need us to be. By working with us, you have access to an integrated network of 300+ manufacturing plants, as well as 13,000 distributors and MRO outlets, and over 1,500 ParkerStores™. That's the kind of global network global businesses demand.

## Flexibility

As the world's motion control expert, Parker offers you a complete range of proven, off-the-shelf products. These products deliver exceptional quality and durability, reducing costs and advancing performance.

## Innovation

It's what drives us. Our mandate for continuous improvement leads us to partner with our customers to create solutions that are smaller, lighter, sustainable, more energy efficient, and highly reliable.

# Hose Products Division Europe –

the market leader and your supplier of choice.



## Put a bite on the braid.

Parker's world-recognized tiger mascot has represented the Parkrimp No-Skive hose assembly program since its introduction in 1980. In a contest originally held by our marketing department, the tiger was the winning suggestion over three others: a turtle (deemed "too slow"), an alligator ("not very good looking") and a shark ("too intimidating" particularly at the time of the release of the movie Jaws).

More than three decades later, the tiger graphic still supports the Parkrimp message everywhere, clearly symbolizing our unique, patented Parkrimp fittings with tapered steel teeth and our Parkrimp crimping machines. Their ability to eliminate hose cover skiving and achieve the metal-to-metal grip of factory assemblies revolutionized the process for markets worldwide. And today, it's the industry standard.

Pride in our products: At Parker, we believe the best fluid connector products for your operation are the ones that get the job done right. We offer the most comprehensive line of hoses, fittings, equipment and accessories you'll need. And if there's something you need that's not a standard product, we're able to design and manufacture it for you with ease.

You'll also benefit from our ultimate competitive advantage – our network of distribution outlets that can provide our products nearly anytime and anywhere. We strive to provide customers with local engineering, local products and local service.

Parker offers the largest selection of hoses plus more fitting sizes than any other manufacturer. You'll find a wide variety of hoses including braided, spiral and multi-purpose, and more than 4,500 Parkrimp fittings. Parker products have been designed, tested and approved to meet and exceed global standards.



The right product is available for your application, including hose that features a variety of abrasion-resistant cover choices, flexibility, a wide range of media compatibility and more – characteristics that make Parker the hose supplier of choice for customers that demand the most from their equipment.

# Hose Products Division Europe –

a long history of providing premier customer service.

Our European division headquarters in Veniano, Italy is our precision-engineered-solution center for products, materials and processes, and is equipped with state-of-the-art

development, testing and performance technology. Hose Products Division Europe has 6 manufacturing locations dedicated to provide a quality product on time. Knowing that

uptime and productivity are major drivers in your business success, we proudly present this catalog outlining Parker's best-in-class hose products and services.



Low, Medium, High and Ultra Pressure Hose



Parkrimp® Hose Fittings



Parkrimp® Assembly Equipment

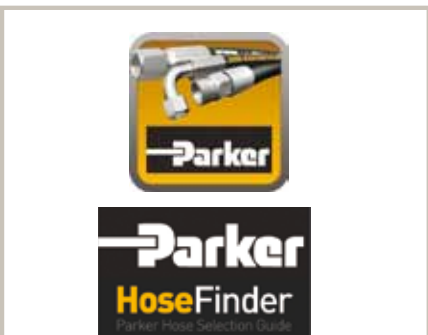

Mobile Phone Applications

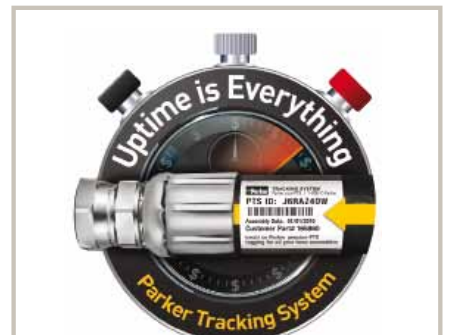

Parker Tracking System



ParkerStore™ Onsite Container Program and Hose Doctor Service



Custom Hose Assemblies and Hose Fittings



Accessories

# Compact Spiral™ Hose

The next evolution in hydraulic hose



**Unprecedented  
35.0 and 42.0 MPa  
hose performance in  
a compact design.**

Compared with conventional spiral hose, Parker's Compact Spiral™ 787TC/797TC hose offers measurably greater advantages in routing and installation, product size and weight, inventory savings and much more. A world first, this development is the most significant advance in hydraulic hose since the introduction of Parker's No-Skive™ technology more than 25 years ago. Compact Spiral was developed in concurrence with the industry trend toward high-pressure hose manufactured to ISO specifications. Its many innovative and proprietary features set new standards in value and deliver hose characteristics deemed most important by OEM and aftermarket customers.

Just one series of hose ends, Parker's 77 series, covers all sizes of both 787TC and 797TC

Compact Spiral hoses, simplifying fitting selection and reducing hose-end inventory.



**For more information about Compact Spiral hoses please refer to pages Da-14 and Da-16**



# Advancing the Industry

Compact Spiral hose delivers substantial performance and value for systems with high-pressure and high-impulse applications. These include large mobile equipment (off-highway, construction, forestry and mining), oil and gas applications and injection moulding equipment.



- 1/2 the bend radius of SAE 100R13/SAE 100R15
- 1/3 less effort to bend
- Nearly 30 % smaller O.D.
- Tested to 2,000,000 cycles
- High abrasion resistance
- Constant pressure
- Simplified fitting selection with 77 series in Interlock No-Skive design
- 25 % less hose weight

## Bend Radius

Compact Spiral hose has half the bend radius of its SAE counterpart and a significantly smaller bend radius than the corresponding size of a Parker conventional spiral hose.

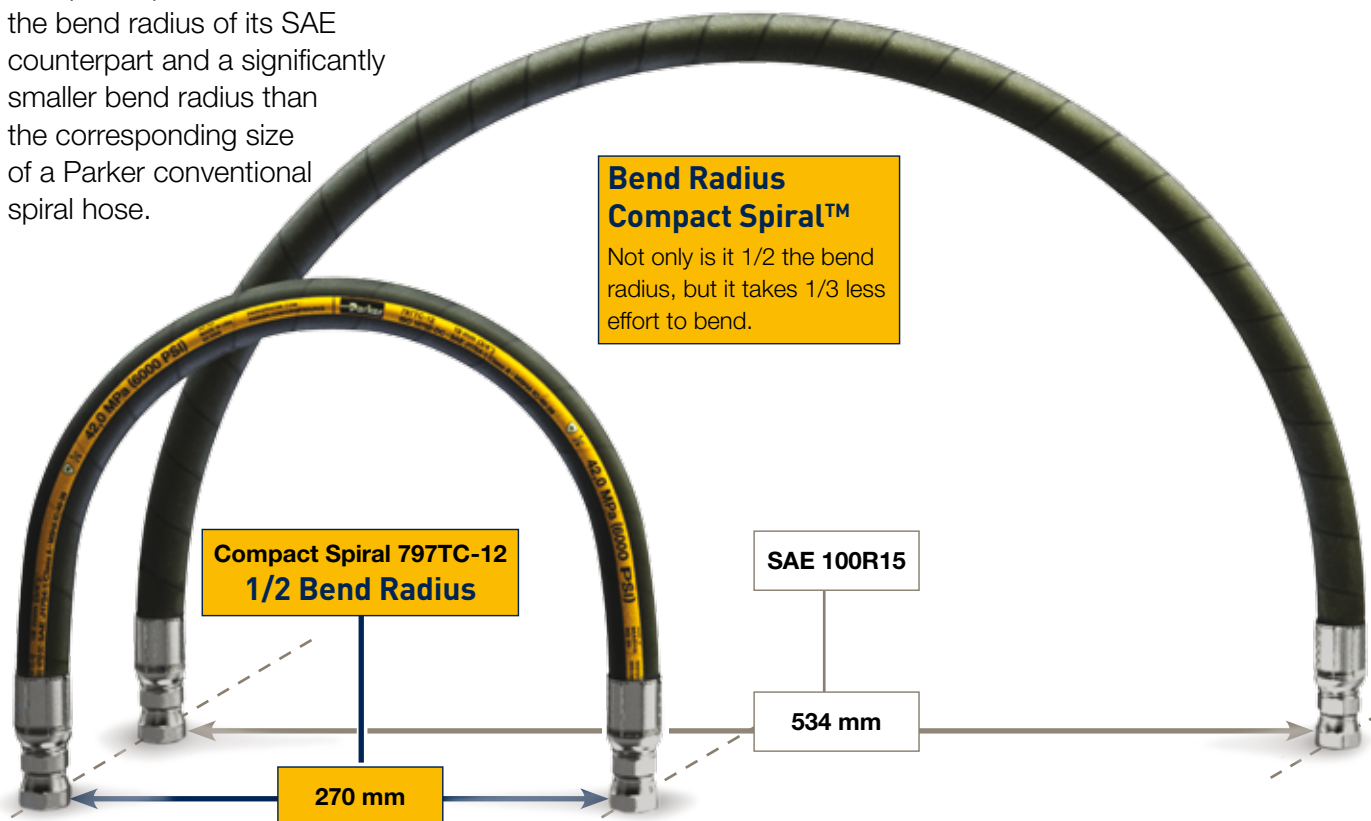

# PowerLift 477

*No-Skive* 2 wire braided hose  
for lifting and materials handling machines



The new **PowerLift 477** hose exceeds the EN required working pressure and the impulse cycles by a factor of two.

**PowerLift** is the ideal choice where lower weight, high pressure and tight bend radii are the driving factors influencing product selection. In addition to the standard **PowerLift** the **PowerLift 477ST** (Super Tough version) is also available. Ideal applications for the **PowerLift** hose are lifting and materials handling machines such as fork lift trucks, aerial lifts, cranes, telehandlers and lifting platforms.

The Super Tough cover increases the hose service life when hoses are exposed to extreme mechanical wear.

The Super Tough cover offers up to 450 times the abrasion resistance specified in the ISO 6945 standard for rubber hoses and provides the perfect alternative to expensive protective sleeves.



For more information about **PowerLift 477** please refer to pages **Ca-24** and **Ca-25**

# RemoFlex 412

*No-Skive* 1 wire braided hose for pilot lines

**RemoFlex** 412 pilot line hose is a highly flexible 12.0 MPa constant pressure hose, ideally suited to the compact build requirements of modern equipment.

The combination of a highly abrasion and ozone resistant cover with its small outside diameter and the excellent fluid compatibility of the hose, through its nitrile inner tube, results in a pilot line hose that meets the demands of a wide customer base.

The **RemoFlex** 412 is ideal for many industrial and mobile applications especially in mobile construction equipment.



For more information about RemoFlex 412 please refer to page Ca-7

# ParLock R50TC

Extra Strong 4 and 6 Spirals  
50.0 MPa Isobaric Hose



For more information about  
ParLock R50TC please refer  
to page Da-30

Requirements for new hydrostatic drives are higher performances combined with the same hydraulic hose size but at improved velocity. With the new R50TC, this market requirement is fully met. Target markets for the new isobaric hose type R50TC are mobile hydraulic equipments with typically large construction or agricultural machines for applications such as hydrostatic drives or powering large bore cylinders where high flow rates, very high pressures and pulse rates are common. R50TC is a 4 spirals hose construction available in sizes -10, -12 and -16 (R50TC-16-SP4). The 6 spirals version is available in size -16 (type R50TC-16-SP6) and size -20. The most common connection types are 8000 PSI flange fittings.

# Universal Push-to-Connect (UPTC) Assembly

The quick, simple, truly universal advantage for your product's design, manufacture and maintenance.

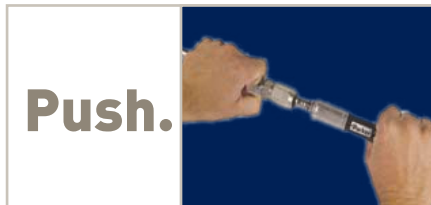

“Push, click, done” literally describes how quick and simple it is to achieve reliable leak-free connections with Parker's UPTC hose and tube assembly. Yet unprecedented speed and simplicity are only part of the total advantage.

Unlike other push-to-connect assembly designs, with Parker's patent-pending assembly you also achieve the “U”—that is, the genuine universality that ensures maximum compatibility and simple global sourcing. So from your equipment's design and production to its maintenance in the field, the UPTC assembly delivers savings never before possible, for everyone up and down the line.

Simply universal economics. Parker's universal, economic UPTC assembly utilizes standard O-Lok (ORFS) or EO (24° DIN cone) fitting bodies, and is suited for hydraulic hose (rubber or thermoplastic) and tube (inch or metric) assemblies. Also, while other push-to-connect couplings require changeovers to new male and female-end fitting designs, any existing Parker O-Lok or EO fitting system can be converted to a push-to-connect design. Thus, the number of UPTC connections is virtually unlimited.

Specifying Parker UPTC in product designs, particularly where space is limited, provides immediate savings in time and cost associated with the assembly process. Plus, UPTC reliability and simplicity extend to the field – helping to significantly reduce errors associated with rework and warranty claims. Here, its key advantages include standard wrench disassembly and no special connector needed for replacement of a damaged hose. Because the fitting body has not changed, a standard ORFS (or UPTC) assembly may be used for replacement, which greatly helps to minimize costly equipment downtime.



- Assembly time savings
- Guaranteed correct connection
- Elimination of hose twist
- Leak-free performance
- Wide range availability
- Easy design implementation
- Excellent field serviceability



**For more information about UPTC please refer to intro-pages medium pressure and pages Cb-47 – Cb-48**

# Full Flange System

Provides full flange mounting option for Code 61 and 62 ports. System flexibility reduces inventory investment.



## Reliability, Ease of Use, Performance, Flexibility

Parker's Hose Products Division introduces a one-piece flange option for Code 61 and Code 62 connections. The patent-pending design enables the flange to be attached to the hose after the hose fitting has been crimped to the hose.

Once the fitting is crimped, an SAE J 518 Code 61 or a Code 62 full flange can be attached using a highly tensile stainless steel retaining ring. The versatile fitting design enables greater flexibility by reducing the number of potential hose fittings in your inventory.

## Hose Fittings

A variety of hose fittings are now available with more to come. Contact your Parker representative or go to [www.parkerhose.com](http://www.parkerhose.com) for the latest list of fittings.

- One-piece full flange connection
- Fittings are compatible with both Code 61 and Code 62 flanges
- All Code 61 sizes rated to 5000 psi

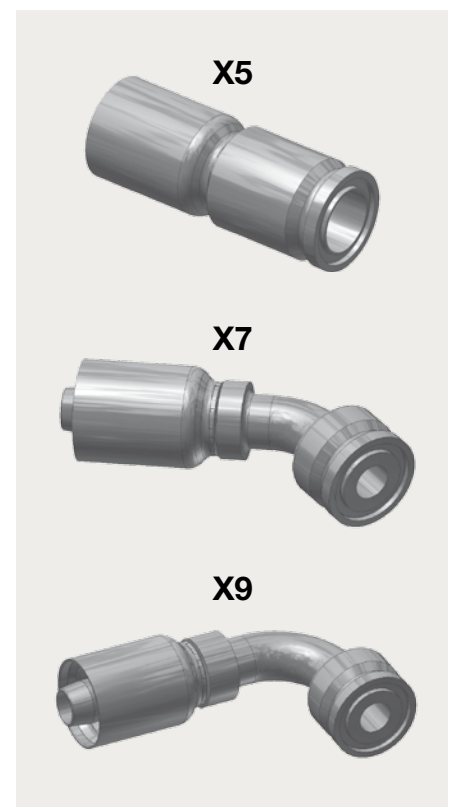

For more information about the Full Flange System please refer to intro-pages high pressure and Df-9 – Df-10, Dk-19 – Dk-20 and Eb-2

# Non Standard and Customised Hose Fittings

Short runs or special applications are met by Parker's Rapid Service Unit (RSU)



The Rapid Service Unit (RSU) is part of the Manufacturing Unit Fittings of Hose Products Division Europe and is a dedicated unit for the manufacture of customised and prototype hose fittings. The unit is responsible for both checking the technical possibilities of the customer request from an engineering perspective as well as establishing the most economic production process. Because of close cooperation

between Parker's Manufacturing Units and the Parker Sales Companies (PSC) the Rapid Service Unit (RSU) can live up to its name by reacting, quoting and supplying rapidly.

After receiving the order, the RSU team will promptly and carefully process the order – from its receipt to the shipping of the fittings. For the production of such fittings, we have dedicated resources in a state-of-the-art manufacturing cell with CNC machinery and tools.



The Rapid Service Unit (RSU) can provide:

- Jump sizes
- Specific end configurations
- Specific drop lengths
- Fitting/tube combinations
- Customised prototypes
- Any batch size upwards from a single piece

Material options include steel, stainless steel, brass and special materials on request.

# R35TC

## Multispiral hose for increased pressure and flow rates

You are looking for a hose that delivers higher working pressures and more power through a higher flow rate? Or do you need a hose for heavy-duty applications with an abrasion-resistant cover for a longer service life?

Parker® R35TC completes the ParLock hose range with size -40 (I.D. 63.5 mm) and has been developed to increase the flow rate and to meet even the most challenging requirements of

various applications, such as high system pressure and high pulse rates.

Due to the enhanced hose diameters and in combination

with very high pressures, the flow rate can be increased, which eliminates the need of numerous pressure lines and results in a cost reduction for connectors.



**For more information about R35TC please refer to page Da-26**

# Hybrid Push-Lok

The excellent combination of two basic materials



**For more information about the Push-Lok system please refer to chapter B1**

Through interactive development of both materials and manufacturing processes, the combination of polyurethane and synthetic elastomer has successfully resulted in the creation of a hybrid Push-Lok hose with exceptional technical properties.

- Hose cover made of high-quality polyurethane, featuring high resistance to welding spatter and abrasion.
- The highly tensile textile braid reinforcement ensures a firm grip of the hose onto the fitting and prevents it from pulling off.
- Synthetic elastomer core tube resistant to hydraulic fluids, dry air, water, water emulsions, etc.

# Environmentally Friendly Plating Process

Chromium-6 has been classified in the EU Directive 67/548/EWG as Category 2, which means that this material may be carcinogenic under certain circumstances. Skin contact can bring about allergic reactions. Since 2006, all Parker steel fittings have been manufactured using trivalent chromate (chromium-6-free) plating. This new process enhances the

corrosion resistance of the fittings, and is more environmentally friendly than the previous hexavalent chromate plating. While the fitting function will not change, the fitting colour will. Fittings plated with trivalent chromate will be silver in colour, not gold. The Chromium-6 free plating process is implemented worldwide at all Parker facilities.

## Chromium-6 Free



## Where corrosion resistance is vital

stainless steel is the perfect solution

For pneumatic and hydraulic applications in demanding environments, your connection requirements will be met by Parker's range of stainless steel products. Parker offers a complete system of stainless steel products such as tubes, tube fittings

or 1- or 2-piece hose fittings for low, medium and high-pressure hydraulic hoses – everything from one source and approved by well known international classification bodies. It goes without saying that Parker's stainless steel components are produced

using superior quality stainless steel grade 1.457. Thanks to their resistance to corrosion and acids, all components are suitable for tough environments. However, some special applications require special materials and here you can rely on Parker as well – we have the resources to produce customised hose fittings for even the most demanding customer requirements.

### Power in Stainless Steel

- Premier customer service
- Single-source solution
- Worldwide availability
- One team for all requirements
- Customized products
- Special materials
- Complementary design of tube & hose fittings



**For more information about our stainless steel range please refer to catalogue CAT/4400.1/UK**



# We offer more

than just innovative products and solutions

## Training in Hose Products

The extensive training programme of the Hose Products Division Europe contains theoretical and practical training sessions. Training takes place on a regular basis in the different Parker locations. Beside standard training Parker offers the possibility for customized in-house training. The main goal of Parker's product training is to acquire special knowledge about hose products, fittings, connectors and catalogues and will enable you to select efficiently and handle safely all Parker hose products.



For further information about the Hose Products Division Europe, please visit our website

[www.parker.com/euro\\_hpd](http://www.parker.com/euro_hpd) and for further information about other Parker products, please call

the European Product Information Centre free of charge on 0800 27 27 5374

## Promotion Material about Parker Hose Products

If you are interested in promotion material about Parker Hose Products, please contact the relevant Parker Service Centre or visit the website [www.parker.com/euro\\_hpd](http://www.parker.com/euro_hpd).

Under the menu bar „Literature“ a library can be found containing the current catalogues, sales & marketing bulletins/brochures, service manuals/user guides, certificates/approvals, technical articles, safety instructions.

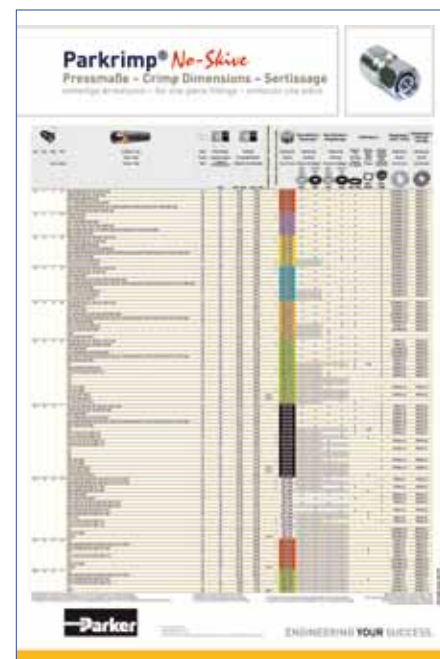

# Value Added Services

to save customers' time and money

## ParkerStore™

At Parker Hannifin, we're continually looking for ways to deliver more products, more efficiently.

The Global ParkerStore™ network enables Parker to provide:

- Prompt, efficient, professional in-store services while you wait
- Expert local services and support
- A safe, friendly and convenient shopping environment
- A greater range of parts options so you get exactly what you're looking for.



Customers trust ParkerStores to provide OEM and MRO customers with direct access to:

- Custom-made hydraulic hose assemblies and complementary products to support their applications and decrease their downtime

- Expert technical support
- Professional, personalized services, including 24/7/365 support
- The convenience, comfort and amenities of a local service provider.

## ParkerStore™ Container Service



The ParkerStore container is a transportable workshop, providing on-site maintenance and product support for large construction projects such as roadworks, tunnels, railways, underground systems, etc. Provides an on-site product and hose replacement service. With this service on your site, you can reduce your downtime keeping your project on time and on budget!

# HOSE DOCTOR®

Parker HOSE DOCTORS® are a network of independently-owned, mobile service technicians built around the commitment to identify and replace hose assemblies wherever their customers need them, with the fastest response times possible.

HOSE DOCTORS® are an extension of the worldwide Parker distribution network, coupling their service commitment with Parker products – the highest quality hoses and fittings available in the market today.



## Kitting

Multiple components are supplied under a single part number

- Reduced number of suppliers
- Reduced stocks and no obsolete items
- Optimized management (stock and supplies)
- Simplified and optimised order handling
- Reduced assembly costs
- Greater productivity



## Tech Services

Optimises the performance of your hydraulic and pneumatic circuits

- With Parker Tech Services involved, your time to market is shorter, which saves on development costs
- The 3 year no-leak guarantee enhances your reputation and lowers your warranty costs
- More reliable operation lowers your customer's operating costs
- More efficient performance and no-leak guarantee is beneficial to the environment
- Parker worldwide coverage ensures you can use the service and save costs wherever you are



## Breadman

Lean logistics and delivery of Parker products and kits directly to the customer's assembly line, work stations or warehouse

- 100 % parts availability minimises downtime, increases production and reduces costs
- Elimination of stock checking reduces manpower and maintains production levels
- Daily delivery reduces inventory and overheads
- Electronic order processing eliminates paperwork and reduces administration costs



# Parker® Tracking System Enterprise

Global asset tagging and identification system

The Parker® Tracking System Enterprise (PTS) is designed to help customers reduce vehicle or asset downtime through increases in the speed, timing and accuracy of necessary repairs. PTS provides a unique 8 digit identification code and bar code printed on a durable label for each hose assembly. PTS labels are specifically engineered to withstand harsh chemicals, temperatures, UV exposure and other challenging conditions.

- PTS captures, records and recalls unique hose assembly information – on demand
- Provides fast and accurate product identification to speed up replacement regardless of where the original assembly was made.
- Assembly can be replaced with only the 8 digit PTS ID number/bar code eliminating the need to remove hoses prior to replacement. This can provide critical machine uptime and enable more conveniently scheduled repair.
- PTS includes additional reporting tools to assist in continuous improvement programmes and preventative maintenance initiatives.

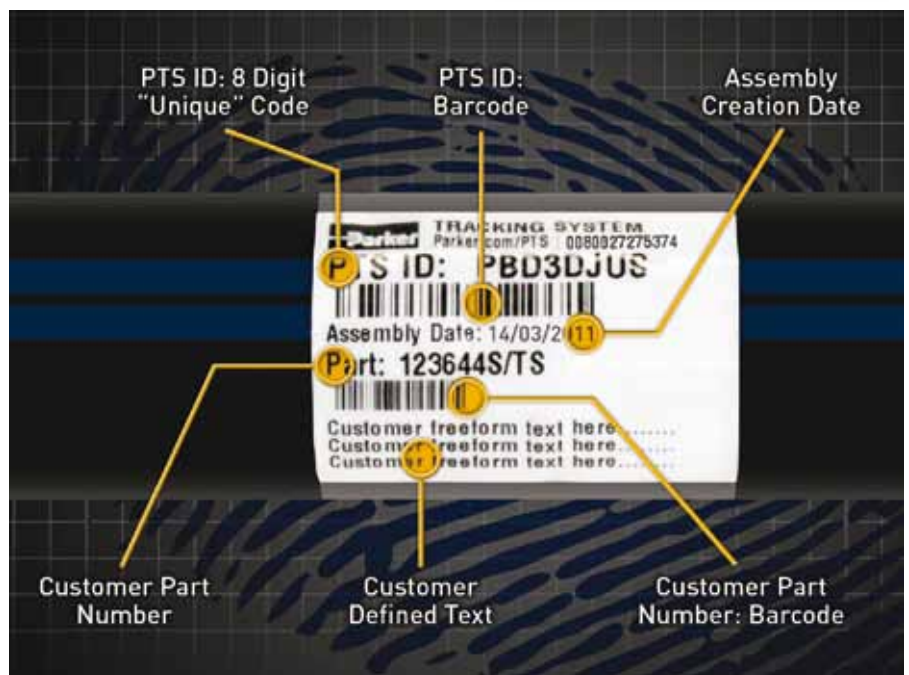

# The benefits of working with Parker Hose

Bring the power of Parker to the palm of your hand.

Parker is committed to delivering customer service options to help you work smarter, faster, and better.

Need the latest? Go online. From complete product information on hose, to 3D-CAD models of our complete fitting line, you'll find everything you need at [www.parkerhose.com](http://www.parkerhose.com).

And HoseFinder, our mobile app, makes it fast and convenient to search for hydraulic hose products and information on the go. The app features an abbreviated STAMP selection process to help you find what you need quickly and easily. Download yours today at [www.hosefinder.com](http://www.hosefinder.com).

Whatever you do, visit our site often. It's the fastest and easiest way to keep up with changing technology and our ever expanding product offering.



**HoseFinder**<sup>2.0</sup>  
Parker Hose Selection Guide



- 1 Browse it.** It's easy to use.
- 2 STAMP it.** Use the STAMP search or browse the catalog to find the product you are looking for.
- 3 Search it.** Results include all the details you need to make an informed decision.
- 4 Find it.** Choose the "Find It" link and you'll be directed to one of Parker's 12,000 worldwide distributor locations.

HoseFinder is currently available for iPhone®, Blackberry® and Android™ mobile phones... and at no charge.

## Technical Handbook

### Low-Pressure Push-Lok

The intelligent Push-Lok System covering different types of rubber, thermoplastic as well as a hybrid hose version and a wide selection of reusable fittings made from steel, brass and stainless steel.

**Pressure range: Up to 2.4 MPa**

### Low-Pressure (Transportation, Air Conditioning, Others)

This low pressure range follows the No-Skive concept and can be assembled on Parkrimp machines.

**Pressure range: Up to 20.7 MPa**

### Medium-Pressure Hydraulics

Hose and fitting product range for applications in mobile and industrial hydraulics. The perfect range for the more demanding market requirements with a broad selection of Parkrimp No-Skive fittings, with over sixty end configurations, combined with Parker hoses and crimpers allows simple and safe assembly – whenever and wherever needed.

**Pressure range: Up to 42.5 MPa**

### High-Pressure Hydraulics

Heavy-duty products for heavy-duty applications with a full range of Parkrimp No-Skive multispiral hoses and fittings and of ParLock skive type hoses and fittings

**Pressure range: Up to 56.0 MPa**

### Assembly Machines / Accessory Products

The perfect complement to the largest range of hoses and fittings in the market. Parker crimping technology is recognised throughout the industry as the easiest and most accurate crimping system available.

# Whatever application you have

we have the best solution

Hose Products Division Europe supplies premier customer service by focussing on customer needs and analysing the entire business environment in which our customers operate.

Macro-market analysis is an important aspect of business planning to engineer and produce the best solution for our customers' requirements and help them to achieve higher levels of profitability.

- What are customers' needs and desires
- What hose technology do customers prefer
- How to advance customers' brand loyalty



## Off Highway Mobile Equipment

Agricultural Equipment, Construction Equipment, Material Handling, Oilfield Equipment, Forest Equipment



## Industrial Equipment

Robots, Machine Tools, Injection Moulding, Metal Processing, Air & Gas Compressors, Other Industrial Equipment



## Transportation

Trucks, Buses, Railways, Military Vehicles



## Processing Industry

Industrial Chemicals Processing, Oil & Gas Processing, Paper Mills



## Marine

Ship Building, On-Shore, Off-Shore



## Power Generation

Wind Power, Power Generation Equipment



## Mining

Underground and Surface Mining, Hard Rock Drilling, Tunneling

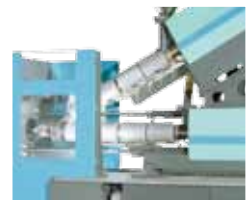





aerospace  
climate control  
electromechanical  
filtration  
fluid & gas handling  
hydraulics  
pneumatics  
process control  
sealing & shielding



# Hydraulic Hoses, Fittings and Equipment

Technical Handbook



ENGINEERING YOUR SUCCESS.

# Parkrimp *No-Skive* and ParLock System

Along with the ever-growing power and efficiency of construction, agriculture and other machinery and increasing working pressures and flow

rates of their hydraulic systems, multispiral hose is gaining an increasingly important role in machine design. Parker Hannifin, as the world

leader in the hydraulic hose market, responds to these highly demanding requirements with 2 comprehensive systems – Parkrimp No-Skive and ParLock.

## Parkrimp *No-Skive* system

is based on no-skiving technology (without removing the rubber cover before assembling)

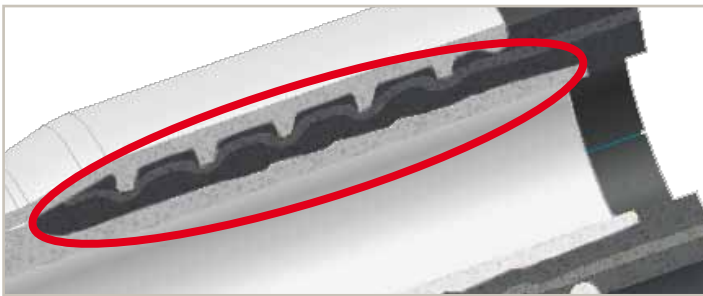

## ParLock system

uses external or internal and external skiving (Interlock) technology

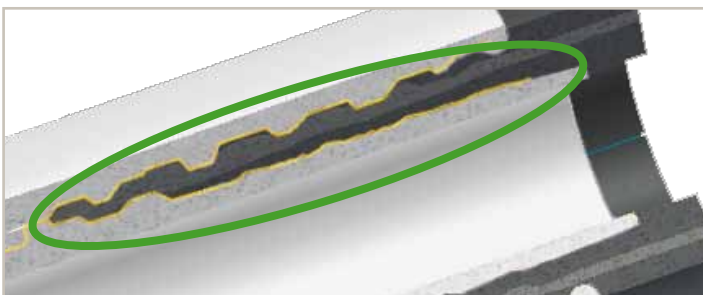

Each of the two concepts has its indisputable advantages – which concept should be selected depends on the particular conditions of the application.

Each of the Parkrimp No-Skive and ParLock systems consists of integrated ranges of hose, fittings and assembling equipment and know-how, all of which are:

- Designed and developed together
- Tested and approved together
- Produced and supplied together

This way Parker Hannifin can guarantee:

- The highest quality and safety and the longest service life of the final product – to the end users, and at the same time:
- The easiest, most efficient and safe production process – to the assemblers.

In this way Parker Hannifin also meets the requirements of SAE J1273 and ISO 17165-2, which pay particular attention to matching the hose with the fittings and to their compatibility proven by the manufacturer.

# Parkrimp *No-Skive*

The easy to operate crimp system  
from textile to 6 spiral high tensile steel wire

Parkrimp No-Skive is synonymous with the best solution for assembling hydraulic and related hose and fittings from both the technical and the manufacturing points of view!

Throughout the progressive rubber and metal compression during the crimping process the reinforcement always remains intact. The meticulous design,

testing and manufacturing processes of Parkrimp No-Skive hose and fittings, combined with the approved crimping diameters provide an excellent mechanical connection between the hose and the fitting. This absolutely leak-free connection gives long service life even with the highest pressures associated with 4- and 6-spiral hose assemblies.

The smartly designed and time-tested Parkrimp No-Skive assembling equipment combined with Parker's assembling know how allow the safest, most efficient and mistake-proof assembly process. The Parkrimp equipment allows cost and time savings to the assembler and guarantees a defect-free, reliable and durable final product to the end-user.

## **Parkrimp *No-Skive* hose and fittings**

the system for fast and leak-free assemblies

- For crimping Parkrimp No-Skive fittings only
- No skiving tool needed
- No need to remove the cover
- Quick and easy: no gauges to set on the machine
- Portable machines for field repair
- Meets EN safety regulations

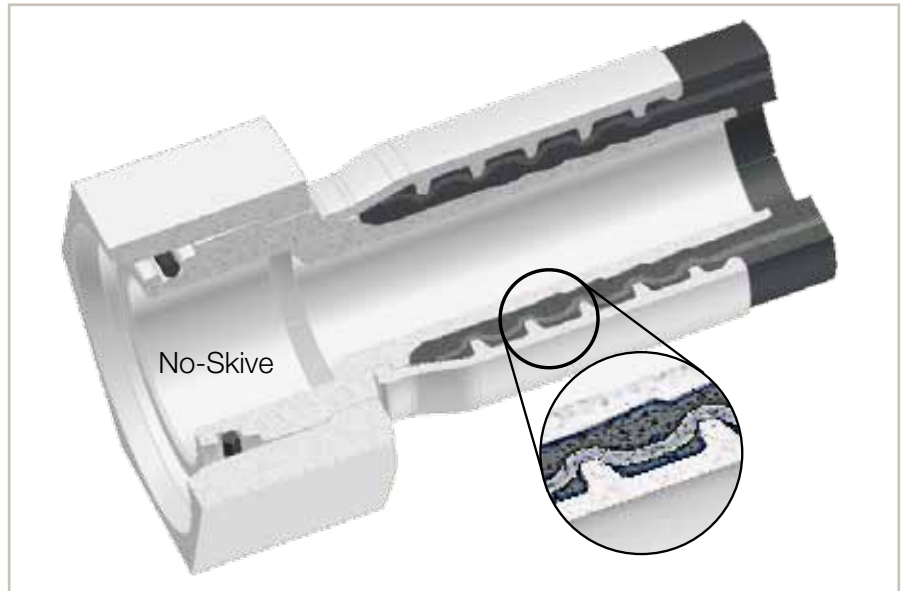

**Parkrimp *No-Skive* hose and fittings** the system with the perfect match

<p><b>The perfect match</b> The complete system from one source. No-Skive hose, No-Skive fitting and crimping machine with world-wide guarantee and availability.</p>	<p><b>Parker's colour-coded die sets</b> No loose parts to mismatch or misplace – die set segments linked together. Die sets provide 360° evenly applied crimping forces for an ideal crimp result.</p>	<p><b>Parkalign®</b> Parker's exclusive Parkalign® positions the fitting in the dies perfectly every time.</p>



# ParLock

The system for extremely dynamic pressure applications

## Applications requiring the ParLock system

- Hydrostatic transmissions (combine harvesters, large tractors, excavators, etc.)
- Large injection moulding machines
- Tunnelling machines
- Forestry machines
- Large material handling machines (container handling)
- Excavator booms
- Blow-out preventers in oil and gas

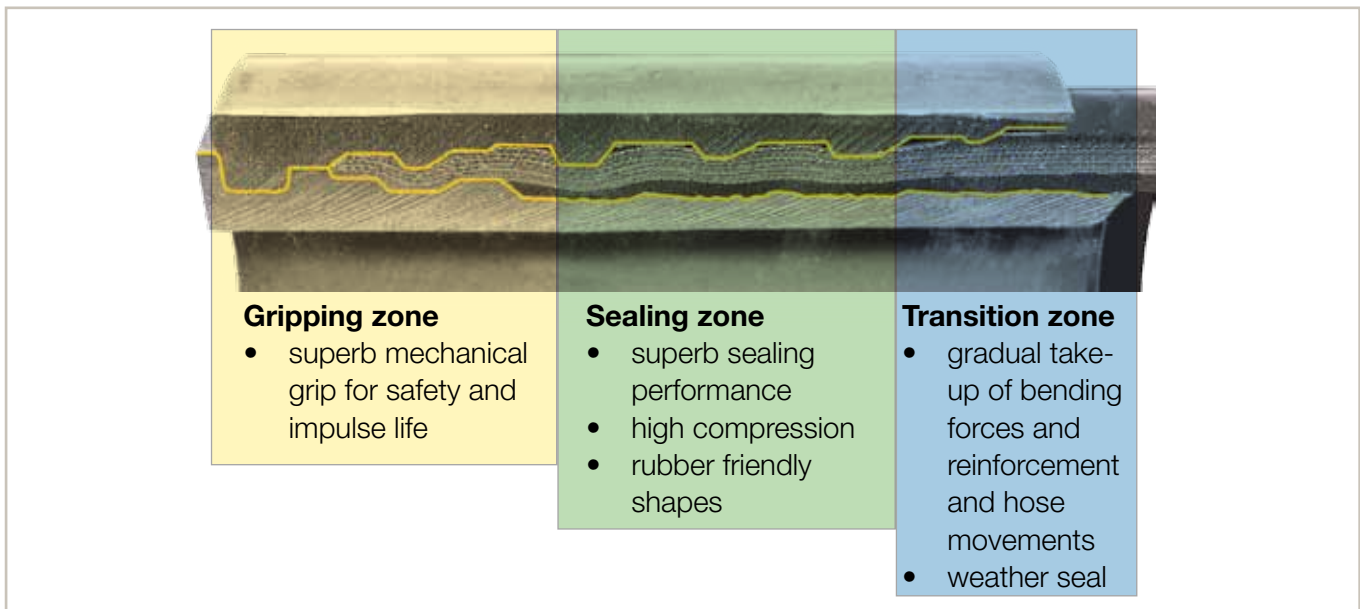

## For manufacturing the ParLock hose assemblies Parker Hannifin offers

- Skiving machines for external and internal skiving
- Universal crimping machines with adjustable crimping diameter
- Detailed assembling instructions (see further in this catalogue)

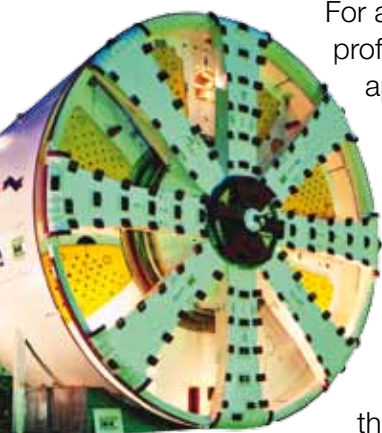

For applications with extremely dynamic pressure profiles, pressure surges and peaks, as well as applications with intense vibrations and hose flexing (bending), especially when close to the fitting, a strong mechanical grip by the fitting onto the hose is paramount.

A popular method accepted by the market of achieving this mechanical grip in such applications is to use hose fittings that „lock“ the metal reinforcement of the hose directly between the metal shell and nipple – for which the rubber of the hose has to be removed both

externally and up to a certain length also internally (a concept generally called „Interlock“).

As a response to the market requirement for an „Interlock“ hose fitting system, Parker has developed the Parlock program. This range consists of a specific range of hose, fittings and assembly equipment combined with Parker crimping know-how.

# Hydraulic Hoses and Fittings

<b>Hoses and Fittings Terminology – The basics</b>	<b>Aa-2 – Aa-8</b>
<b>Safe Hose Assemblies in 8 Steps</b>	<b>Aa-9</b>
1 Application	Aa-9
2 Pressure	Aa-10
3 Size	Aa-10
4 Temperature	Aa-11
5 Fluid Compatibility	Aa11
6 Hose Fittings	Aa-11
7a Working Steps for One-Piece Parkrimp No-Skive Fittings	Aa-12 – Aa-14
7b Working Steps for Two-Piece ParLock Fittings	Aa-15 – Aa-16
8 Routing, Installation, Environmental influences	Aa-17 – Aa-19
<b>How to Order (Part number description)</b>	<b>Aa-20 – Aa-21</b>
<b>Hoses and Fittings Storage</b>	<b>Aa-22 – Aa-23</b>
<b>Safety Precaution</b>	<b>Aa-24 – Aa-25</b>
<b>Proactive Maintenance Programme</b>	<b>Aa-26</b>
<b>Technical Data</b>	
Hose Overview	Ab-2 – Ab-3
Hose Fittings Overview	Ab-4 – Ab-7
Hose Fittings Pressure Ratings	Ab-8 – Ab-10
Hose Fittings Nomenclature	Ab-11 – Ab-14
Classification Bodies	Ab-15
Classification Body Type Approvals	Ab-16 – Ab-17
Conversion Chart	Ab-18
Temperature / Pressure Chart	Ab-19
Flow Capacity Nomogram	Ab-20
The Correct Method to Fit Female Swivel Ends	Ab-21
Chemical Resistance Table	Ab-22 – Ab-30
Identifying Fitting Types	Ab-31 – Ab-41
Safety Guide	Ab-42 – Ab-45



# Hoses and Fittings Terminology

– The basics!

Hydraulic hose is a full-value part of the hydraulic system transmitting the hydraulic power – not just conveying a fluid – and deserves adequate attention, just like the other hydraulic components which generate, consume or control that power. Furthermore, it is just hydraulic hose assemblies that are usually most exposed to various extreme conditions in which they have to retain full functionality and assure serviceability of the hydraulic system and safety of the operators.

In spite of that, the importance of the hydraulic hose is often overlooked and underestimated.

This catalogue is to provide guidelines to correct hoses and fittings selection and hose assembly manufacturing and to highlight the most important safety aspects for its service in the field.

## Hydraulic Rubber Hoses

**Tube** – inner layer of rubber compound with chemical and physical properties to be long-term resistant to the fluid and working conditions.

**Reinforcement** – 1 or 2 (exceptionally 3) layers of braided textile fibre or highly tensile steel wire or 4 or 6 layers of spiralled very highly tensile steel wire to bear high pressure but allow flexibility of the hose.

**Cover** – outer layer of rubber compound with chemical and physical properties to protect the reinforcement against ambient conditions and mechanical damage.

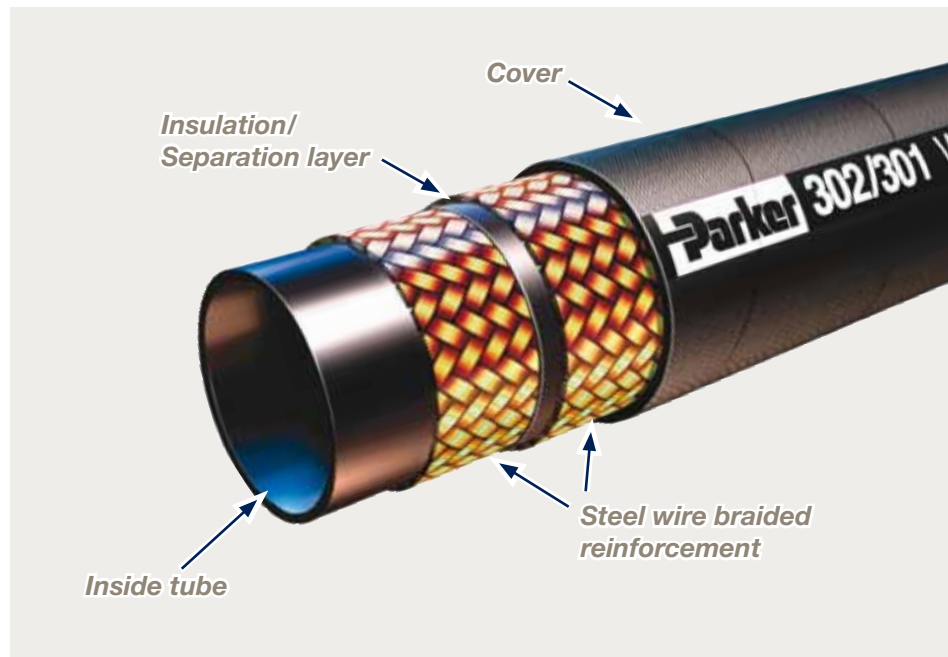

**Depending on the pressure level we classify the hydraulic hoses in this catalogue into 4 groups:**

- **Push-Lok**
  - low-pressure hoses with self-grip connection to fittings
- **Low pressure and Transportation**
  - 1 and 2 textile yarn braided and 1 steel wire braided hoses
- **Medium pressure**
  - 1 and 2 steel wire braided hoses and suction hoses
- **High pressure**
  - 3 steel wire braided hoses and 4 or 6 spiral steel wire braided hoses
  - 4 spiral steel wire braided compact hoses

**Depending on the method of hose and fittings assembling we offer 2 basic product concepts (integrated product lines of hoses, fittings, assembling equipment and know-how):**

- **Parkrimp No-Skive**
  - complete range of braided and spiralled hose, not needing removing (skiving) of the hose cover before assembling.
- **ParLock**
  - specific range of 4 and 6 spiral hose for extreme applications which require skiving of the cover and for bigger sizes also of the inner tube.

## Hose Fittings

**Nipple (insert etc.)** – the inner part of the fitting of which, one end is coupled to the counterpart of a hydraulic component (termination end), while the other end is inserted into the hose (tail end).

To assure compatibility and leak-free sealing of the hose fitting with the other connectors, designs of termination ends are standardized according to numerous national and international standards.

The main role of the tail end is to provide durable sealing between fitting and hose.



**Shell (socket, ferrule etc.)** – the outer part of the fitting provides mechanical connection of the fitting with the hose. To assure a strong hold of the hose reinforcement, shells are generally crimped on to the hose during assembly.

The design of the tail end and the shell profile is the sole responsibility of the respective manufacturer. Due to this reason many different designs are found in the market (only the design of the termination end and the functionality of the entire hose assembly is specified in the international standards).

### Note

Parker Hannifin also offers a limited range of 2-piece Parkrimp No-Skive fittings but being special products they are not included in this catalogue. For more information about 2-piece fittings, please contact our Division Helpdesk (HPDE\_Helpdesk@parker.com)

**In this catalogue we offer 3 kinds of fittings:**

- **Push-Lok**

- special nipples connectable to Push-Lok hose without any shells.

- **1-piece fittings**

- pre-crimped shells on nipples make the assembling of hose with fittings easier, more effective and reliable.

- **2-piece fittings**

- for extreme applications requiring full metal-to-metal connection of the hose reinforcement with the shell or even with the nipple (external or external plus internal skiving).

**Except Push-Lok, all fittings in this catalogue are crimped and include:**

- All Parker 1-piece fittings
  - suitable for the **Parkrimp No-Skive** product line
- All 2-piece fittings in this catalogue
  - suitable for the **ParLock** product line



Aa-4





## Hose Assembly

It is the interplay between the fitting tail and shell designs and the hose design with its material properties that primarily determine performance, service, durability and safety of the final hose assembly. Yet compatibility of hose and fitting cannot be just theoretically projected. It requires exhaustive and repetitive laboratory and field tests and further tuning of the designs.

Non-compatibility of hose with fittings or even the combination of hose and fittings from different manufacturers, do not just only influence the performance of the hose assembly, they often lead to hose failure with serious health or life-threatening consequences! For this reason the main international standards ISO 17165-2 and SAE J1273 strictly warn not to mix hose with fittings from different manufacturers without their approval.

Parker Hannifin has not approved products of any other manufacturer for combination with Parker hoses and/or Parker fittings and guarantees full compatibility, reliability and safety only for combinations of genuine Parker parts selected and assembled in accordance with the guidelines included in this catalogue!

### Hose Hint

Never mix & match one manufacturer's fittings with hoses from another manufacturer.

Parker hoses, fittings, assembling equipment and know-how are designed as an integrated system. Only this ensures optimum product performance, reliability and safety!



## Pressure Rating

Hydraulic hose is a component transmitting hydraulic power and the pressure is obviously the main physical quantity determining the hydraulic power. For hydraulic hoses the following pressure ratings are used:

**Working Pressure** – the pressure for which the hose assembly is designed to operate over its whole service life - provided the other parameters (temperature in particular) stay within reasonable limits.

For apparently static applications (e.g. with hand pumps or water jetting) consult the Working Pressure with your Parker Field Representative or with our Technical Support (HPDE\_Helpdesk@parker.com).



**Burst Pressure** – the pressure which statically applied causes destruction of the hose. Technical standards for hydraulic hoses define the burst pressure to be equal to or higher than **4 times the working pressure** (safety factor 4). This rule and the burst pressure in general serve to hose manufacturers for design and testing of the hose only! If you happen to know the burst pressure of certain hose, never use this rule backwards to deduce its working pressure!

$$4 \times \text{Working Pressure} = \text{Burst Pressure}$$



# Hose and Fittings Terminology

## Remember the working pressure

1. The **hose assembly working pressure** is given by the weakest "link in the chain" - i.e. by the lowest of the working pressures of the hose and of both fittings. Do not forget to check the working pressure of the fittings when selecting components for a hose assembly (see pages **Ab-8** to **Ab-10** of this catalogue)!
2. The **real hydraulic system operating pressure** is not given by the system components setup but by the application which introduces into the system peaks and surges or by the functioning of the system itself (rapid closing or opening) which induces spikes and pulses. Such occurrences are detectable only by sensitive electronic pressure gauges and are usually not fully or not at all filtered out by safety or relief valves and exert excessive strain on the hydraulic system – hoses and tubes first of all!
3. The **hose assembly working pressure** must always be **equal to or higher than the real hydraulic system operating pressure** incl. all peaks, surges, spikes and pulses!



## Unit of measure

The most commonly used unit of measure for hydraulic pressure worldwide is MPa (Mega Pascal) – used also in this catalogue. In the US and in Anglo-Saxon markets also psi (pounds per square inch) is officially used and many European producers, users and even technical standards still also use bar.

For the conversion chart of various units of measure see page **Ab-18**.

## Hose Hint

Working pressure is a dynamic parameter, burst pressure is a static parameter. High burst pressure does not mean high working pressure!

In order to assure mutual compatibility, producers of hydraulic equipment, producers of machines and also international technical standards profess certain preferred pressure levels:

MPa	21	28	35	42
bar	210	280	350	420
psi	3000	4000	5000	6000



## Hose Hint

For highly demanding applications (dynamic pressure, high number of pressure cycles, high temperature etc.):

- Select hose with much higher working pressure than officially requested
- Select multispiral hose instead of braided or ParLock instead of Parkrimp No-Skive
- Select all of that in order to increase service life and safety!

## Hose Size

The other parameter determining the hydraulic power in direct proportion is the flow rate – i.e. the fluid velocity. However, too high fluid velocity gives rise to turbulence, pressure drops and heating up of the fluid, causing excessive ageing of hoses and other components or even their damage. To keep the fluid velocity below certain limits but achieve the required flow rate, the size of the hose has to be defined appropriately (see Flow Capacity Chart on page **Ab-20**).

As the first technical standards for hose came from the USA, dimensions of hose are defined in inches and hose sizes are expressed in inches or from inch-derived units. Global companies – such as Parker – use **dash sizes** (-1 = 1/16”), while the European standards use DIN-based DN (diameter nominal) sizes.



dash	inch	DN	mm
-3	3/16	05	4.8
-4	1/4	06	6.4
-5	5/16	08	7.9
-6	3/8	10	9.5
-8	1/2	12	12.7
-10	5/8	16	15.9
-12	3/4	19	19.1
-16	1	25	25.4
-20	1.1/4	31	31.8
-24	1.1/2	38	38.1
-32	2	51	50.8

### Note

SAE 100 R5 hydraulic hose, SAE J1402 air-brake hose and SAE J2064 air-conditioning hose use sizes equivalent to corresponding metal tube I.D. – different from the other hydraulic hoses (see datasheets of these hoses in this catalogue).

Size	Inch	mm	DN
-6	6/16	$6/16 * 25,4 = 9,525$	10
↓	↓	↓	↓
-6	3/8	9,5	10

## Ambient and Fluid Temperature

Temperature is one of the factors which most negatively affect rubber characteristics and so it deserves particular attention of the hydraulic system designers and hose users!

High temperature causes degradation of rubber and accelerated ageing of the hose – an effect which can be yet further intensified by the chemical impact of the fluid. That is why the upper temperature limits specified in this catalogue refer to the fluid temperature and why they differ for various media. However, permanent or long-term use at temperatures close to the upper limit would considerably shorten the hose service life in any case and if it cannot be avoided the hose should be replaced more frequently once it shows first symptoms of deterioration (stiffness, hard cover and cracks).

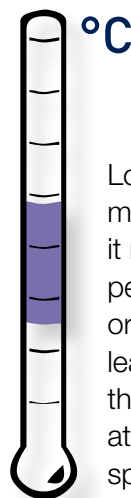

Aa-7

### Hose Hint

The combination of high temperature and high pressure reduces the hose service life. Pay attention to regular inspection of such hoses and their preventive replacement if the cover is brittle or cracked!

Low temperature, on the other hand, affects mainly physical properties of rubber – making it more fragile – and so at extremely low temperatures hose being bent may crack in tube or cover which can cause immediate or later leakage, burst or reinforcement damage. As there are not many hydraulic fluids which flow at or below -40 °C, the lower temperature limits specified in this catalogue refer rather to ambient temperature below which the hose should not be bent or otherwise hit from outside (while staying passively in it does not cause serious problems).

# Hose Bend Radius

### Hose Hint

Bend radius and bending force are two different things! Not even apparently “flexible” hose (with low bending force) may be bent below the min. allowed radius!

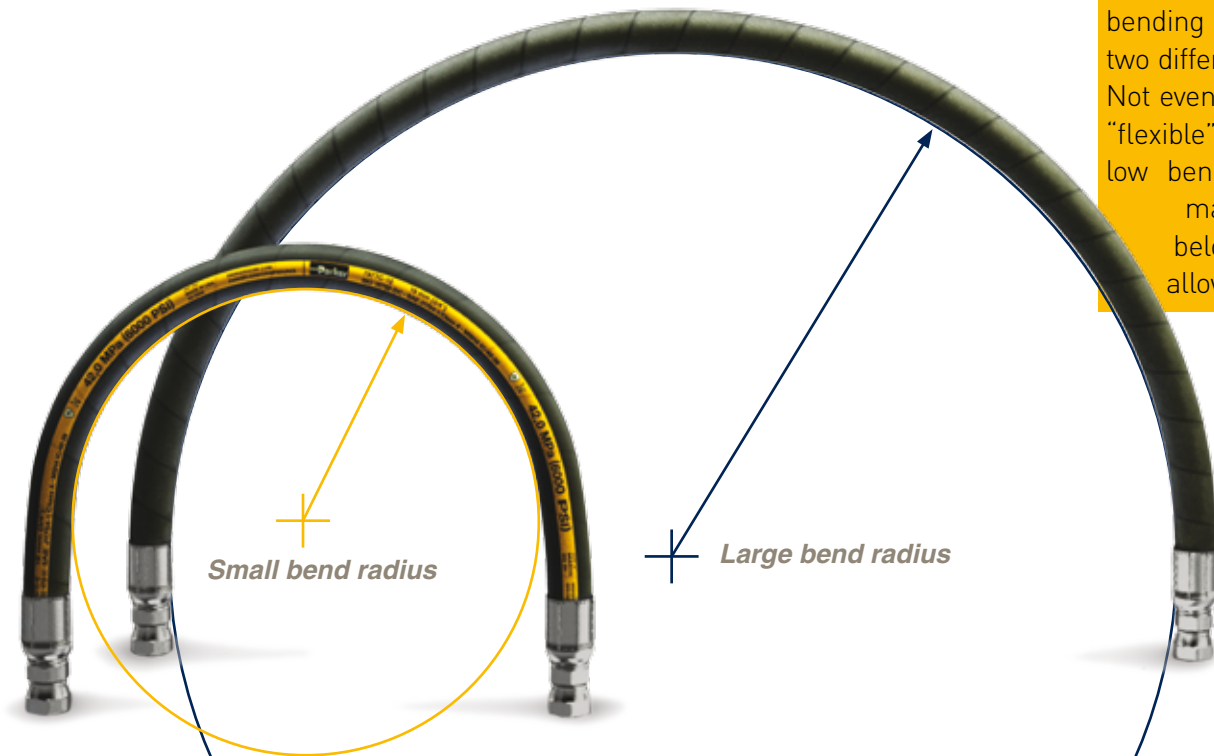

### Remember

In order not to displace the hose reinforcement and/or damage its tube or cover, hydraulic hoses must never be bent below the min. bend radius specified in this catalogue – even without any pressure or even in bulk when stored or packed!

The role of hydraulic hose is to provide a connection of relatively movable parts of the circuit and so its bending is a natural state the hose is designed for. However, the layout of the reinforcement wire or fibre inside a bent hose **may** shift to less appropriate positions. The tube and cover are stretched and become thin-

ner and so the pressure resistance of a bent hose considerably decreases. For this reason working pressure and bend radius are negatively interdependent parameters and the max. working pressures specified in this catalogue are conditioned by respecting the min. bend radii.

## Recommended Fluids

As the power transmitting – not fluid conveying – element, hydraulic hose should be first of all used for the primary applications and with the recommended fluids specified in this catalogue!

For low pressure applications with various non-hydraulic fluids see our catalogue “**4401 Industrial Hoses**”.

If for required higher pressure or for any other reason you cannot use industrial hoses, follow the instructions in this catalogue (pages **Aa-9** – Application, **Aa-11** – Fluid Compatibility and **Ab-22** to **Ab-30** – Chemical Resistance Table).

# Safe Hose Assembly in 8 Steps

## 1. Application

There are so many operational factors affecting the functionality and service life of hydraulic rubber hoses and there is such a wide variety of external circumstances they have to work in that some few basic parameters such as pressure, size and fitting types cannot provide a sufficient basis for selecting and producing the proper product.

The only unfailing way is to start ... from the end – to learn and thoroughly understand the application the hose assembly will work in.

### Hose Hint

You do not always need additional sleeve to protect the hose against abrasion!

Parker high and extremely high abrasion resistant **TOUGH COVER** and **SUPER TOUGH** versions with 80-times and 450-times higher abrasion resistance do the same, but better and cheaper!

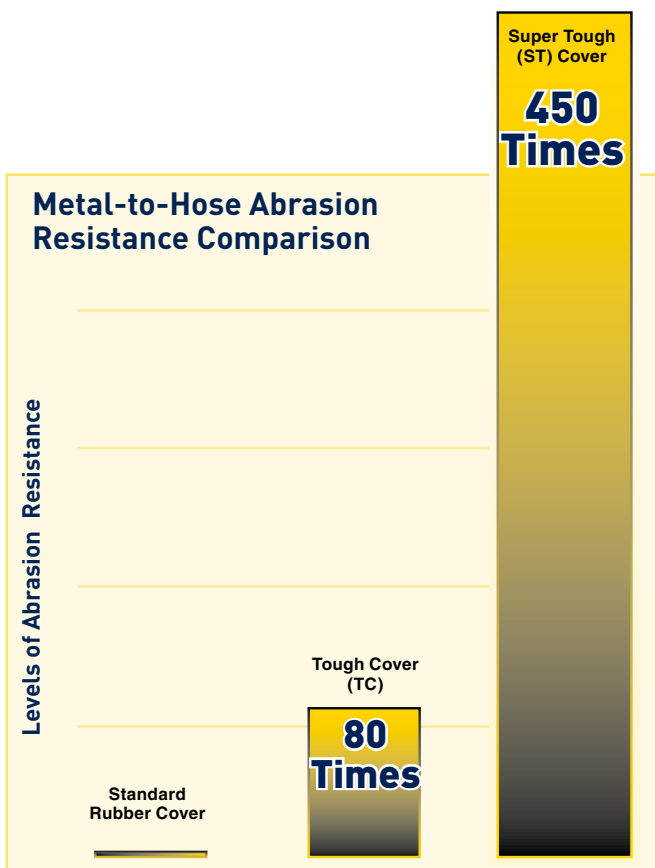

### Main operational factors:

- Market (agriculture, construction, marine, mining, ...)
- Machine / equipment type
- Hydraulic system pressure
- Static / dynamic
- Extreme pulses (frequency, amplitude)
- Surges, peaks, spikes
- Suction strains
- Flow rate
- Ambient / fluid temperature (permanent, peak)
- Biodegradable oil
- Other fluid – liquid / gaseous
- Bend radius
- etc.

### Main external circumstances:

- Extreme environmental conditions
- Ultraviolet light / sunlight
- Ozone / smog / salt water
- Restricted space
- Abrasives / sharp-edged objects
- Mechanical loads (strain, stress, torsion)
- Mechanical vibrations
- Fittings heated
- Fittings under voltage / current
- Electrical / magnetic field
- Heat exposure
- Flame / fire exposure
- etc.

### Other requirements:

- Certificate / approval needed
- Special (OEM) specification
- Environmental requirements
- Work safety requirements

# Safe Hose Assembly in 8 Steps

## 2. Pressure

Working pressures of both hose and fittings must be equal to or higher than the real hydraulic system operating pressure incl. all surges, peaks, spikes and pulses!



For hose working pressure rates see pages **Ab-2** to **Ab-3** Hose Overview.

For fittings working pressure rates see pages **Ab-8** to **Ab-10** Hose Fittings Pressure Ratings.

For the absolute majority of hydraulic applications incl. for the highest pressure 4- and 6-spiral hoses we advise to use the **Parkrimp No-Skive** product line. It provides really supreme solutions for hydraulic and related hoses and fittings from both the technical and the manufacturing points of view!

For applications with extremely pulsing dynamic pressure, pressure surges and peaks, as well as for applications with intense mechanical vibrations and hose flexing (bending), especially close to the fittings, we recommend using the **ParLock** product line.



## 3. Size

To avoid turbulence and their negative consequences for hose and other components in the hydraulic circuit, certain limits for fluid velocity have been set based on long-term experience with hydraulic systems. The limits differ for pressure, return and suction lines, as the hydraulic flow tends to turbulences the more the lower the pressure.

### Max. recommended fluid velocity:

- Pressure lines – ca. 6.1 m/sec
- Return lines – ca. 3 m/sec
- Suction lines – ca. 1.2 m/sec

However, there is no need to calculate the velocity. Depending on the flow rate and kind of hydraulic line in which the hose is intended to serve (pressure / return / suction) you can assign the required hose size in the Flow Capacity Nomogram on page **Ab-20**.



### Hose Hint

Don't try to save your own or your customer's money by downsizing the hose!

It would cost your customer more to replace damaged hoses, other components and oil, and it will cost you more as you may lose your customer!

The size of the hose is directly included in the hose part number: e.g. 302-6-ISO 1436/DIN EN 8532SN hose **size -6** (3/8"- DN10)



## High Temperature

For high temperature hoses choose the part numbers ending in “6” – e.g. **436-12** - SAE 100R16  
High Temperature hose size -12

## Low Temperature

For extremely low temperature hoses choose the part numbers ending in “LT” – e.g. **461LT-16** – DIN EN 857-2SC  
Low Temperature Hose size -16

## 4. Temperature

The main technical standards for hydraulic hoses specify the max - min temperature range usually (not always) as:

- EN standards and EN/DIN-based ISO standards  
-40 °C to +100 °C
- SAE standards and SAE-based ISO standards  
-40 °F to +250 °F / -40 °C to +121 °C

For Parker hoses you can find the recommended temperature ranges for fluids and for water and air (when applicable) in the datasheet of each hose type in this catalogue.

Besides a complete range of standard hoses Parker also offers a wide range of special types for low and high temperatures – see pages **Ab-2** to **Ab-3** Hose Overview.

## 5. Fluid Compatibility

You can find recommended fluids for Parker hoses in the datasheet of each hose type in this catalogue.

If the required fluid is not mentioned in the Recommended Fluids Chart and if due to higher pressure or for any other reason you cannot use Parker industrial hoses (see Parker catalogue “4401 Industrial Hoses”) pay the highest attention to obtain as much information as possible about the fluid (temperature, pressure, state – liquid or gaseous etc.) and about the working conditions of the hose (see par. 1. Application).

Then check the compatibility of the fluid with the given hose and material of the fitting in the Chemical Resistance Table pages **Ab-22** to **Ab-30**.

The Chemical Resistance Table concerns solely the hose inner tube. Hydraulic hoses should never be submerged in the hydraulic fluids! If you need to know the resistance of the hose cover, consult our Technical Support (HPDE\_Helpdesk@parker.com)

## 6. Fittings

### Hose Hint

Although fittings are made of steel, their working pressure is often lower than that of hose! Don't forget to check the working pressures of both fittings when selecting components for your hose assembly!

Even if the fitting termination end is given by the other component in the hydraulic circuit or the hose assembly is just for replacement, you have to pay attention to choosing the correct fittings compatible with the given hose for the required working pressure and fluid.

To identify the corresponding termination end see pages **Ab-31** to **Ab-41** Identifying Fitting Types.

For each type of hose the series of the compatible fitting is indicated in the hose datasheets in this catalogue – e.g. Parker hose 701 is to be assembled only with Parker Fittings Series 70.

Always check the fitting working pressure – see pages **Ab-8** to **Ab-10** Hose Fittings Pressure Ratings.



## 7a. Working Steps for 1-Piece Parkrimp *No-Skive* Fittings

### Cutting

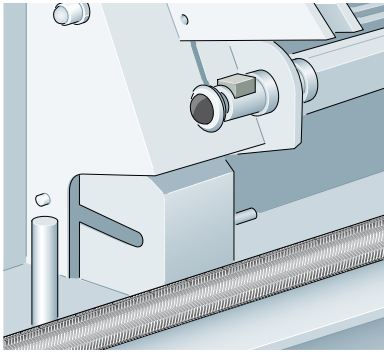

Hose is cut to the desired length according to specifications. The correct hose cutting tool ensures a square, clean cut without damaging the pressure reinforcement. Depending on the hose type, different kinds of cutting blades must be used:

- 1) Smooth cutting blade:  
for high tensile textile layer, return line hoses and steel wire braided hoses
- 2) Serrated cutting blade:  
for hoses with 4 or 6 spiral layer of high tensile steel wire

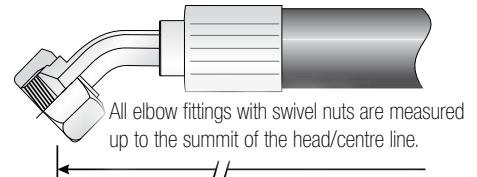
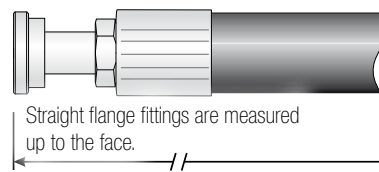
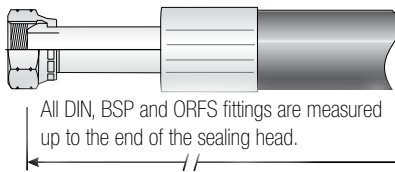
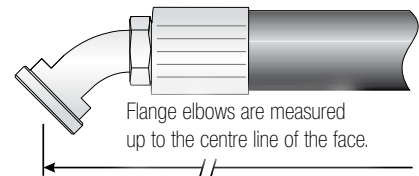
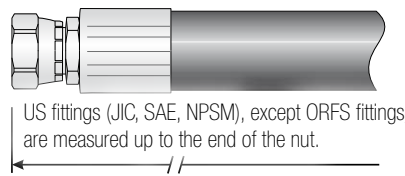
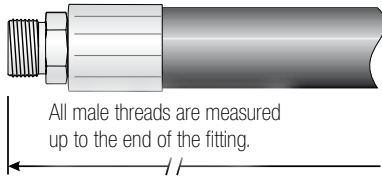

#### Tolerances for hose assemblies

Length tolerance according to DIN 20066 and DIN EN 853 to DIN EN 857

Hose assembly length	up to DN25 (size -16)	from DN32 (size -20) up to DN50 (size -32)	from DN60 (size -40)
up to 630	+7 -3	+12 -4	+25 -6
over 630 up to 1250	+12 -4	+20 -6	
over 1250 up to 2500	+20 -6	+25 -6	+25 -6
over 2500 up to 8000		+1,5 % -0,5 %	
over 8000		+3 % -1 %	

**According to DIN EN ISO 4413, hose assemblies are not permitted to be manufactured from any components that have already been in use in other hose assemblies.**

### Cleaning after cutting

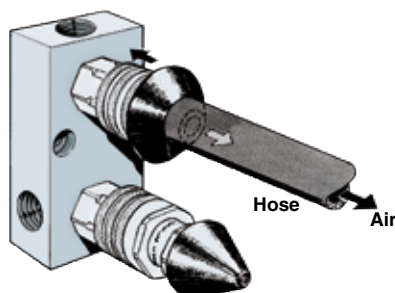

After cutting it is recommended to clean the hose with compressed air from both sides. Please make use of Parker's Cleaning System TH6-7 – A quick and simple system – Delivered with two plastic nozzles for hoses from size -4 up to -32. The hose is pressed against the nozzle and thereby opens a valve to allow the compressed air to blow through the hose and blow out loose particles.



## Marking

According to EN and ISO standards, hose assemblies must be clearly and permanently marked. They must bear the following information:

- Manufacturer's identification
- Date of production (year and month)
- Maximum permissible working pressure limit of hose assembly

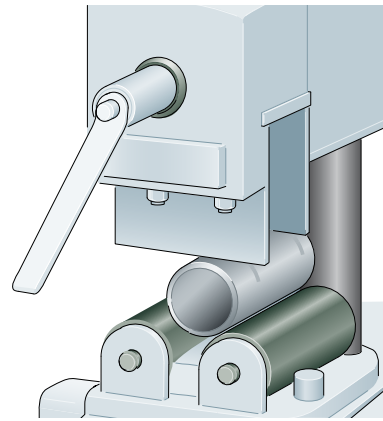

## Crimping 1-Piece Parkrimp No-Skive Fittings

Crimping is the safest, fastest and most commonly used method of making a hose assembly. The Parker crimping systems ensure precise, leak-free and tear-proof assembly of hose and fitting. Reaching the exact crimping diameter is possible with Parkrimp crimping tools or adjustable crimping tools. When crimping, it is essential that hose, fitting and crimping tool (dies) match precisely. For crimping dimensions please refer our crimp charts on pages **Ed-1** to **Ed-11**.

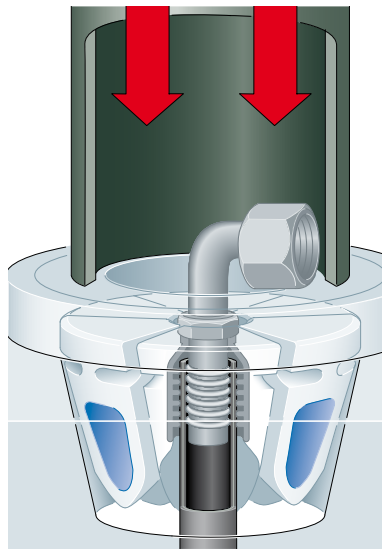

Furthermore, the insertion depth, a square cut hose, correct, burr-free and clean crimping are important to ensure a correctly formed and leak-free connection of hose and fitting. Using the Parkrimp hose crimpers or adjustable crimpers, the fitting is crimped onto the hose in one slow and smooth crimping procedure. A depth stop with automatic function ensures safe positioning of the fitting. This guarantees the correct crimping of hydraulic hose assemblies.

### 26, 46, 48, 70, 71, 73, 76, 77, 78, 79, S6 series:

Push the hose all the way into the coupling.

Place the hose next to the fitting shell and mark the insertion depth or the length of the fitting onto the hose – (lubricate hose end if necessary), push the hose into the fitting until the mark on the hose is even with the end of the shell.

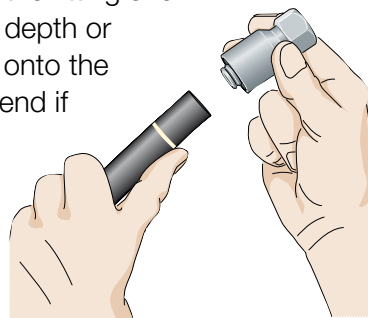

### Angle setting

The displacement angle of a hose assembly is indicated only when two elbow fittings are assembled in a displaced way.

The angle always has to be indicated clockwise looking from the elbow fitting at the back to the one in the front. Please also consider the natural bending of the hose.

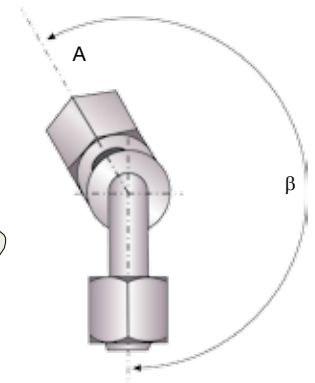

**Parker representatives  
can support you with  
training or advice !**

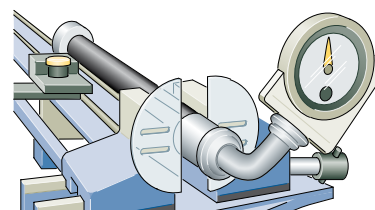

# Safe Hose Assembly in 8 Steps

## Testing (optional)

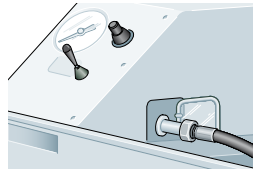

Static test pressure depending on the hose type and application is applied to the finished hose assembly for a pre-defined period of time. The test procedure can be documented using a test logging unit. The test pressure for Parker hydraulic hose assemblies is 2 times the value of the dynamic operating overpressure.

### Proof Pressure Test

This test is typically carried out on customer request according to a method defined by the ISO 1402 standard. The test should be done at normal ambient temperature with a proof test bench using water or another suitable liquid. The hose assembly should be pressurised for between 30 to 60 seconds at twice the working pressure of the hose assembly. There should be no leakage or pressure drop. A complete test report should be provided together with the hose assembly to the customer.

## Cleaning

The hydraulic systems have to reach a defined degree of cleanliness. For this purpose we use cleaning devices which ensure fast and efficient cleaning of hose assemblies.

With the TH6-6 standard cleaning device, certain cleanliness classes can be achieved. This cleaning device first flushes the hose assembly with an anticorrosive emulsion and dries it afterwards with pressurised air.

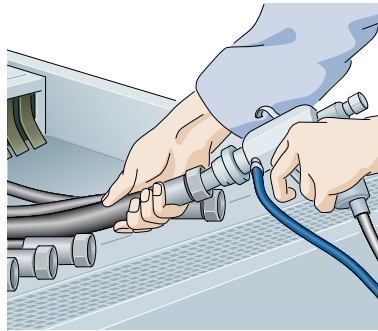

For permanent protection of the finished hose assembly against impurities we recommend using plastic caps.

ISO 4406	NAS 1638	SAE 749
11/8	2	
12/9	3	0
13/10	4	1
14/11	5	2
15/12	6	3
16/13	7	4
17/14	8	5
18/15	9	6
19/16	10	
20/17	11	
21/18	12	



## 7b. Working Steps for 2-Piece ParLock Fittings

Cutting, cleaning after cutting and marking please see “Working Steps for 1-Piece Parkrimp No-Skive”

### Skiving

For the skiving of hydraulic hose, one distinguishes between internal skiving and external skiving. This system is applied for hose types with 4 or 6 spiral reinforcement layers, the so-called Parker ParLock System or Interlock.

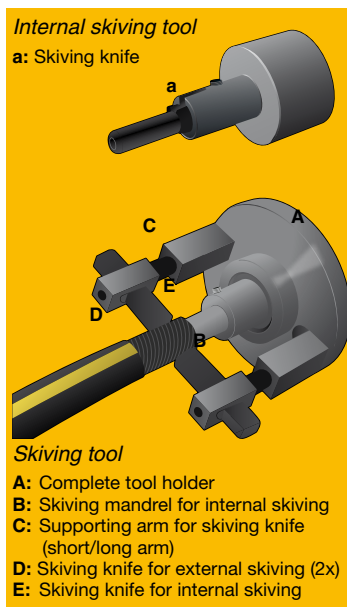

#### Adjustment of tools for internal skiving

Select the skiving tool according to the manufacturing documents and the hose size. Insert the knife for the internal skiving mandrel into the borehole of the mandrel provided for this purpose and mark it with a lock collar at the straight surface. When adjusting the knife, observe the marking on the internal skiving knife and insert the mandrel into the tool holder.

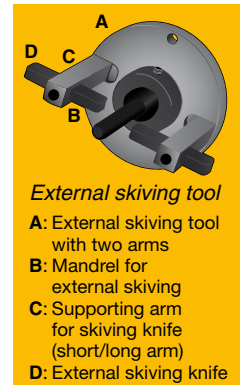
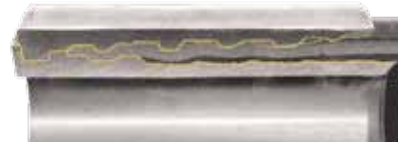

#### Adjustment of tools for external skiving

Attach the knives in the supporting arm. Select the supporting arm (long or short) depending on the hose size. Adjust the knives according to the Parker working instructions and insert the tools into the machine. Push the mandrel onto the hose until it is close to the tool (external or internal skiving knife).

#### Adjustment of the sense of rotation of the machine

Always skive into the direction of the spiral layers. Please observe the operation instructions of the machine.

### Cleaning after skiving

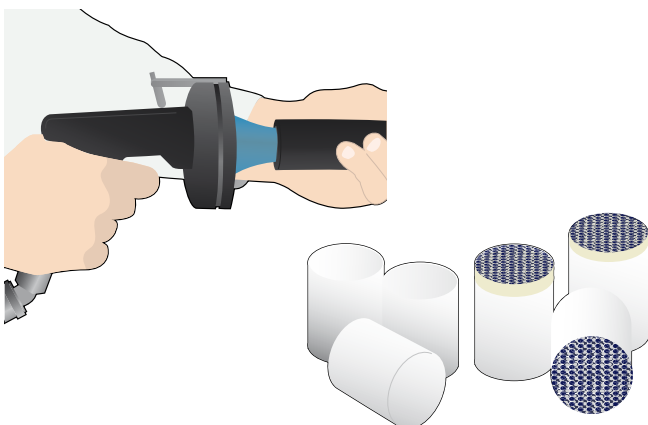

All hose types which have been skived externally or internally should be cleaned immediately after skiving. For this purpose we recommend using cleaning plugs which are shot through the hose using compressed air. (e.g. TH6-10-EL-7 or TH6-10-HL-9-2)

In addition to this working step, the finished hose assembly must be cleaned from both ends using pressurised air after the completion of this working step.

# Safe Hose Assembly in 8 Steps

## Crimping 2-Piece ParLock Fittings



For crimping ParLock fittings V4 series a minimum of 320 tons crimping force is recommended. Min. of 340 tons for V6 series.

- 1) Select the appropriate crimping dies using the crimping diameter chart.
- 2) Before crimping hoses and fittings it must be ensured that you have the most recent crimping dimensions. For crimping dimensions please refer our crimp charts on page **Ed-12** to **Ed-13**.
- 3) Insert the dies into the crimping press and set the crimping diameter.
- 4) Place the pre-assembled hose assembly into the crimper and perform the crimping procedure.
- 5) Please observe the operating instructions of the crimper.

**! 2-piece fittings must not be crimped on Parkrimp crimpers – only with adjustable crimpers.**



Make sure that the hose ends are cut squarely. Push the ferrule onto the hose. The cut end of the hose must be clearly visible.

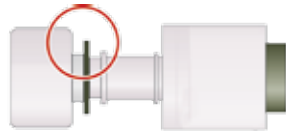

Push the nipple down into the hose until it reaches the stop on the lower groove (plastic ring, fitting shoulder or metal stop). Use Hoze-Oil, if required.



The ferrule must bottom up against the plastic ring or metal stop.

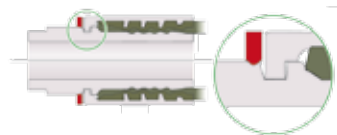

After crimping, the ferrule must be located precisely in the groove of the nipple.

### Angle setting

please see “Working Steps for 1-Piece Parkrimp No-Skive”

## Checking for the correct crimping diameter

In case of the ParLock System, the conicity is measured. It is measured at the beginning and the end of the ferrule in 2 measuring planes.

The conicity must be within the tolerance range specified in the Parker specification.



Measurement 1  
in the plane of force



Measurement 2  
displaced by 90°



Measurement 1  
at the beginning and the  
end of the ferrule



Measurement 2  
at the beginning and  
the end of the ferrule  
(displaced by 90°)

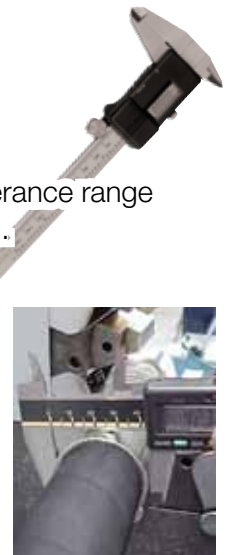

Testing and cleaning please see  
“Working Steps for 1-Piece Parkrimp No-Skive Fittings”

## 8 Routing / Installation / Environmental Influences

wrong

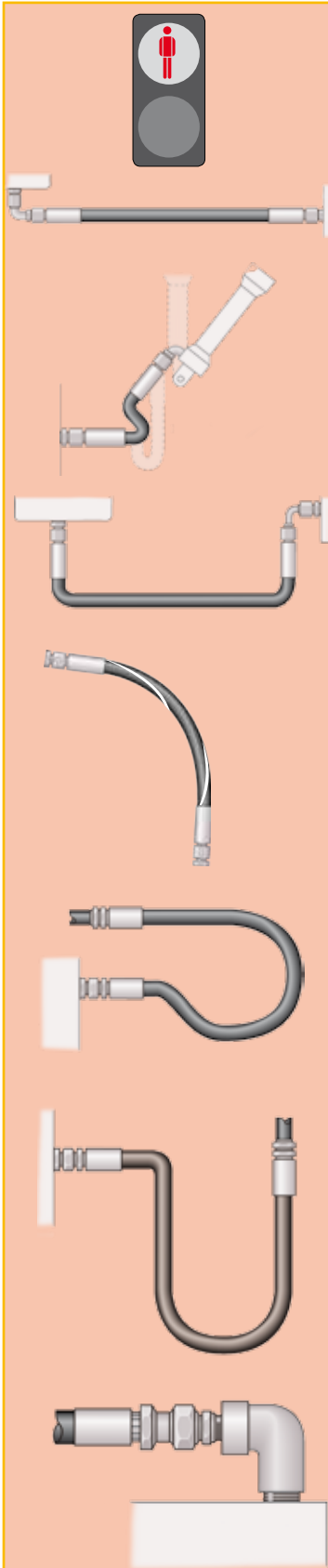

The **routing** of the hose assembly and the environment in which the hose assembly operates directly influence the service life of the hose assembly. The following diagrams indicate the correct routing of hose assemblies that will maximise its service life and assure a safe working functionality.

When hose installation is straight, it must be assured that there is enough slack in the hose to allow for changes in length that occur when pressure is applied. When pressurized, hose that is too short may pull loose from its hose fittings or stress the hose fitting connections, causing premature metallic or seal failures.

The **hose length** must be determined so that the hose assembly has enough slack to allow the system components to move or vibrate without creating tension in the hose.

However, care needs to be taken not to allow too much slack and therefore introduce the risk of the hose snagging on other equipment or rubbing on other components.

Mechanical straining of the hoses needs to be avoided, so the hose must not be bent below its minimum bend radius or twisted during installation. The minimum bending radii for each hose is stated in the hose tables in the catalogue.

The plane of movement must also be considered and the hose routing selected accordingly.

Hose routing also plays an important role on the selection of the hose fittings, as the correct fittings can avoid straining the hoses, unnecessary hose length or multiple threaded joints.

right

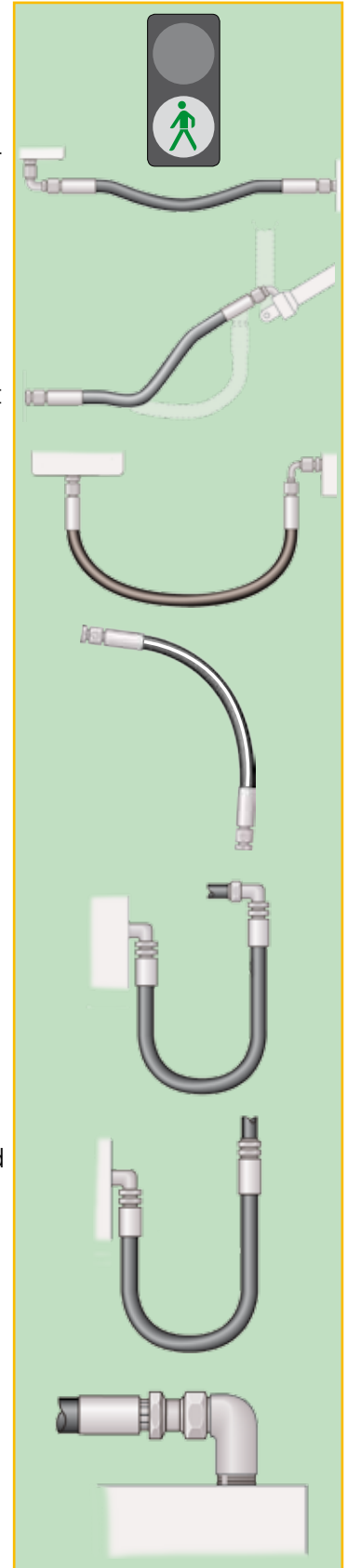

# Safe Hose Assembly in 8 Steps

wrong

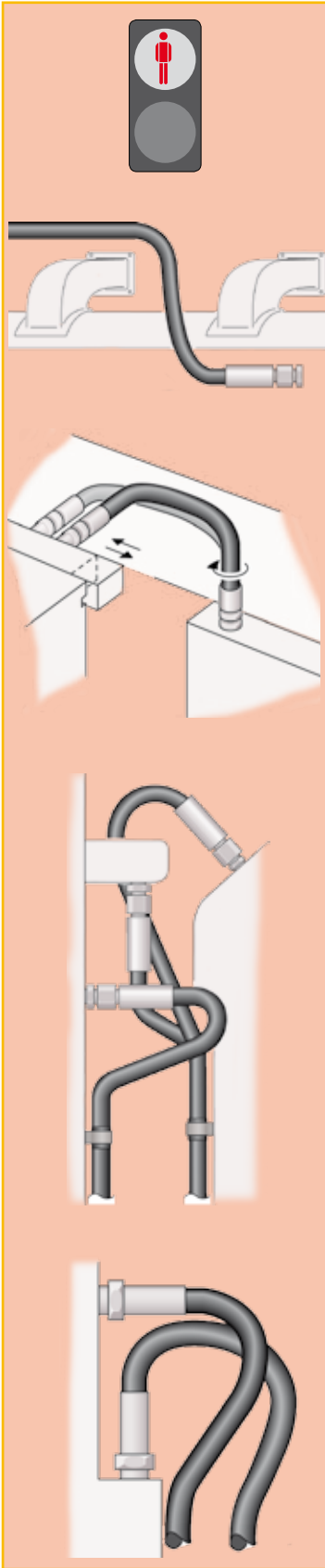

**Correct clamping** (holding/supporting) of the hose should be exercised to securely route the hose or to avoid the hose contacting surfaces that will cause the hose damage.

It is however, vital that the hose be allowed to keep its functionality as a “flexible-pipe” and not be restricted from changing in length when under pressure.

It should also be noted that hoses for high- and low-pressure lines shall not be crossed or clamped together, as the difference in changes in length could wear the hose covers.

Hose should not be bent in more than one plane. If hose follows a compound bend, it shall be coupled into separate segments or clamped into segments that each flex in only one plane.

Hoses should be kept away from hot parts as high ambient temperatures shorten hose life. Protective insulation may need to be used in unusually high ambient temperature areas.

Whilst the importance of the functionality is primate the aesthetics and practicality of the installation should also be considered in the design.

It should be considered that maintenance might be necessary at some stage in the future, so prohibitive design routings should be avoided.

right

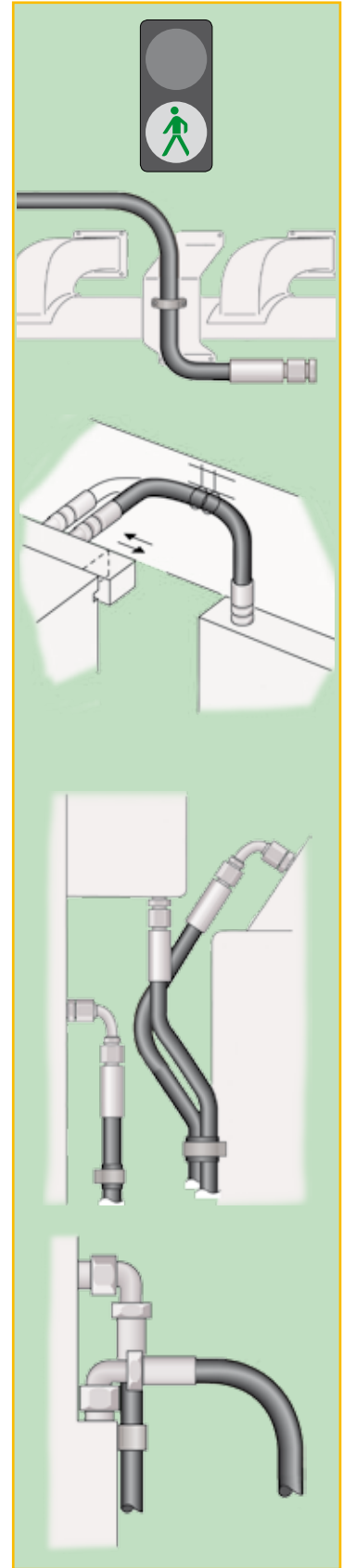

**wrong**

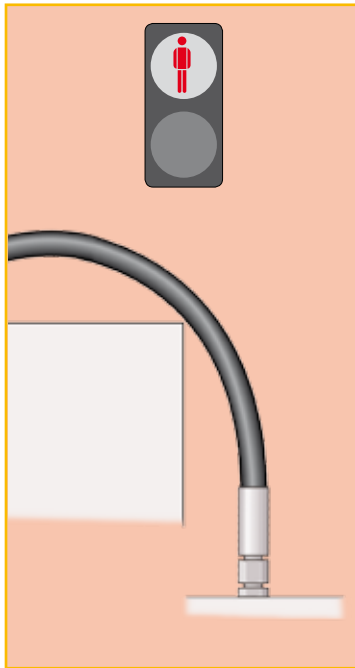

## Abrasive influences

In general care should be taken that the hose is not exposed to direct surface contact that will cause abrasive wearing of the outer cover (either hose to object or hose to hose contact). If however, the application is such that this cannot be avoided, either a hose with a higher abrasion resistant hose cover or a protective sleeve need to be used.

Parker **TOUGH COVER** (TC) or **SUPER TOUGH** (ST) covers offer 80 times or respectively 450 times the abrasion resistance of standard rubber covers.

**right**



## Pollution of hydraulic circuits

Modern hydraulic equipment is becoming highly precise and as such more sensitive, so as a result the importance of a clean working fluid in the system is growing. Because as many as 75 % of hydraulic system failures are caused by contamination of the fluid by solid particles, the initial cleanliness of hydraulic components, as the main source of these contaminants, is vital. With hose assemblies most of the pollution/contaminates enter the hose assembly during its production and mainly during the cutting (or skiving) process.

In order to avoid system failures, all hose assemblies should be cleaned before use (cleaned and plugged before shipping) with suitable cleaning equipment such as the Parker TH6-6 machine.

The level of contamination is defined in three popular norms: ISO4406, ISO4405 or NAS 1638. Most common however, is the ISO 4406, which describes the number and size of solid particles in the hydraulic system by means of a classification value e.g. 16/13.



ISO 4406	NAS 1638	SAE 749
11/8	2	
12/9	3	0
13/10	4	1
14/11	5	2
15/12	6	3
16/13	7	4
17/14	8	5
18/15	9	6
19/16	10	
20/17	11	
21/18	12	

# How to Order

To make ordering Parker products easier, we have itemized the order numbers on this page. This will be especially helpful when you order hose assemblies. You can find further useful hints on the following page.

## 1. Hose

**Example:** **436-6**



436-6 > **Hose type**

436-6 > Hose **inside diameter** in size

## 2. Hose Fittings

**Example:** **1 CA 48 - 12 - 6**

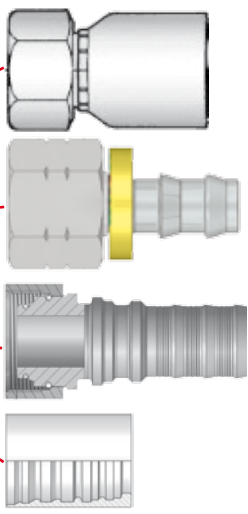

**1** = Crimp fitting

**3** = PushLok fitting

**K** = Nipple component (ParLock fittings)  
example: KC9VS-16-8

**100** = Shell component (ParLock fittings)  
example: 100VS-8

**1** CA 48 - 12 - 6 > **Fitting**

**1** CA 48 - 12 - 6 > **End configuration nomenclature**

**1** CA **48** - 12 - 6 > **Parker Fitting series**

**1** CA 48 - **12** - 6 > **Thread or tube size**

**1** CA 48 - 12 - **6** > **Hose size and hose fitting size**

*I.D. = size -6*

### Material/ specification:

Without suffix: steel, zinc plated  
 B: brass  
 C: stainless steel  
 K: without a plastic ring  
 SM: metric hexagon dimension

The content of the hose crimping tables shows the standard part numbers. For the availability of non standard parts/materials please contact your local Parker service centre. All part numbers printed in bold in the respective price list are available ex-stock.



# 3. Hose Assemblies

Example: **P436CACF12106-1000-0-SG900**

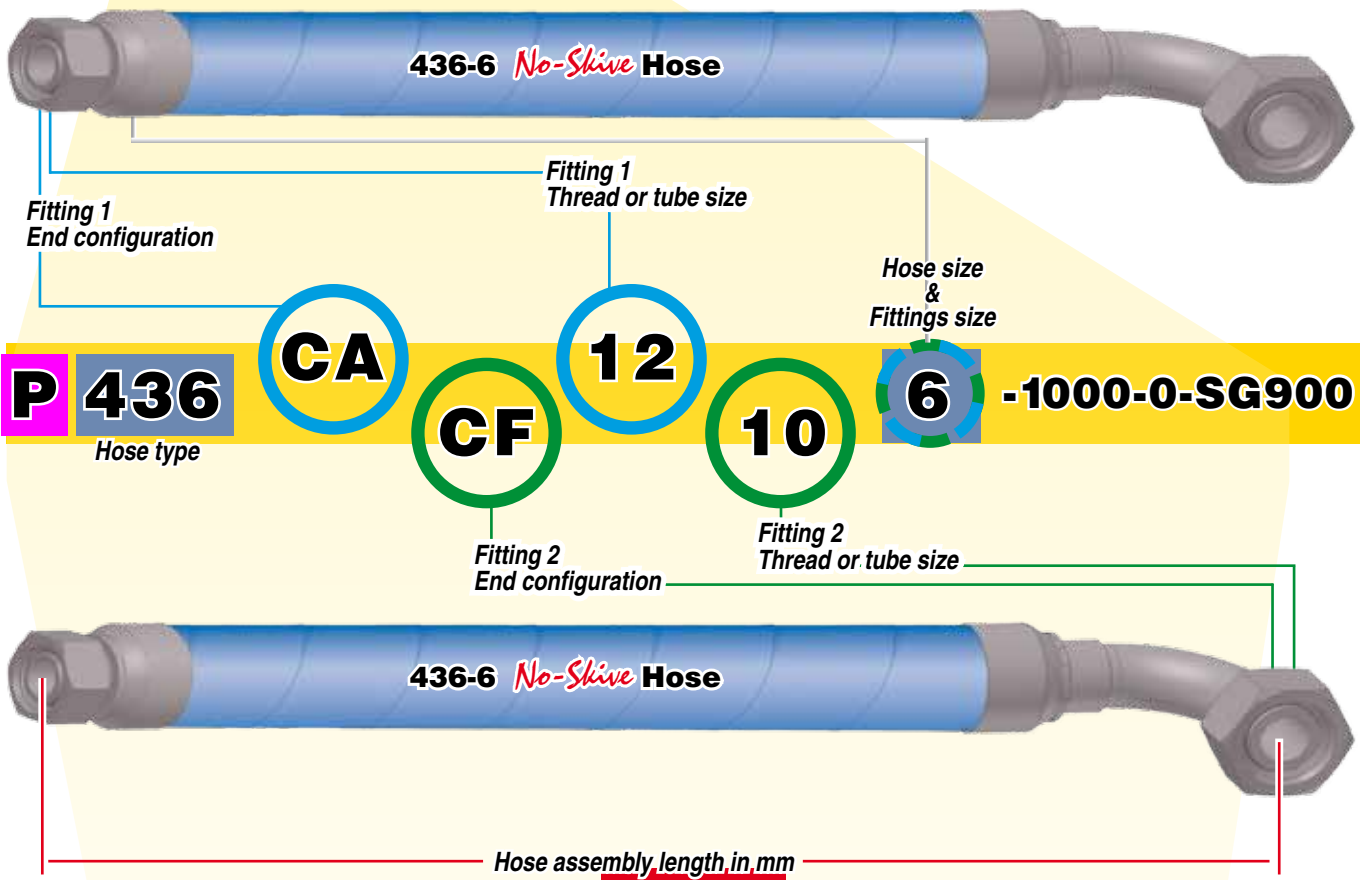

**P** **436** **CA** **CF** **12** **10** **6** **-1000-0-SG900**  
 Hose type      Fitting 1 End configuration      Fitting 1 Thread or tube size      Hose size & Fittings size      Fitting 2 End configuration      Fitting 2 Thread or tube size

**P436CACF12106-1000-0-SG900**

- R = Low Pressure Push-Lok Fittings Series 82
- P = Parkrimp *No-Skive* Fittings Series 26, 48
- D = Parkrimp *No-Skive* Fittings Series 46
- F = Parkrimp *No-Skive* Fittings Series 70, 71, 73, 76, 77, 78, 79 and S6
- E = Parlock Skive Fittings Series VS
- V = Parlock Skive Fittings Series V4
- S = Parlock Skive Fittings Series V6

Accessory,  
e.g. spring guard 900 mm length

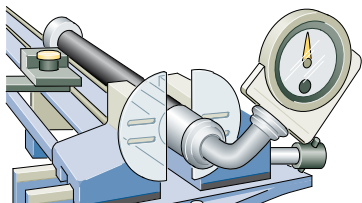

Displacement angle is relevant when the hose assembly has bent fittings

SG	Spring Guard
AG	Armour Guard
AS/PS	Partek Nylon protective sleeve
FS	Fire Sleeves
HG	PolyGuard-Hose Protector
PG	ParKoil-Hose Protector

## Explanation of the example

Hose assembly with hose 436 in size -6 and fitting series 48. Hose assembly length 1000 mm.  
 Fitting 1: end configuration CA has a 12 mm pipe diameter and has a size -6 hose nipple  
 Fitting 2: end configuration CF has a 10 mm pipe diameter and has a size -6 hose nipple  
 The displacement angle for this combination is 0 degrees. On request a displacement angle can be specified for the bent fitting in relation with the hose curvature. A protection sleeve as a spring guard in length 900 mm is on the hose assembly.

# Hose and Fittings Storage

It is a well-known fact that rubber properties deteriorate during the time of storage and service. A system of hose age control should be maintained to ensure that hose is used as long as it retains full capabilities for rendering the intended service. However, it is impossible to advise the ideal storage period and service life of rubber hose as it is subject

to a variety of factors which may affect the rubber characteristics and the suitability for use. That is also why various standardization committees take very different approaches to rubber hose storage period and service life. The main national and international standards defining rules for rubber hose storage are the following:

## DIN 20066

### Fluid power systems – Hose assemblies – Dimensions, requirements

Specifies bulk hose shelf life and hose assembly storage period and service life:

- The shelf life of bulk hose before assembling must not exceed 4 years.
- The service life of a hose assembly, incl. any period of storage, must not exceed 6 years.
- The period of storage of a hose assembly must not exceed 2 years.

#### Bulk Hose

#### Hose Assembly

Shelf life – max. 4 years	Service life – max. 6 years Storage max. 2 years
------------------------------	--

## BS 5244

### Recommendations for application, storage and life expiry of hydraulic rubber hoses and hose assemblies

Specifies tests needed for various storage periods of hose (in bulk or hose assembly):

- Storage period does not exceed 3 years – no tests needed.
- Storage period is between 3 and 5 years – proof pressure test needed.
- Storage period is between 5 and 8 years – proof pressure, burst, impulse, cold flexibility and electrical tests needed.
- Bulk hose or a hose assembly older than 8 years – must be scrapped.

For hose assembly service life no explicit limits are specified, whereas it is recommended to establish rules for each particular equipment and application on the basis of records taken from the real service.

## ISO 17165-2 / SAE J1273

### Hydraulic fluid power – Hose assemblies – Recommended practices for hydraulic hose assemblies

The specified max. shelf life of bulk hose or a hose assembly is 10 years (40 quarters) from the date of manufacture (vulcanization) of the hose, provided it has been stored in accordance with ISO 2230 (Rubber products - Guidelines for storage) and passes visual inspection and if need be also a proof pressure test. If visual inspection gives rise to any doubts as to the functionality of the hose (cracks in the cover or tube after hose flexing, excessive stiffness, reinforcement rust etc.), a proof pressure test should be carried out before use or the hose should be scrapped.

#### Hint

German and the British standards are the most rigorous.

## ISO 8331

### Rubber and plastic hoses and hose assemblies – Guide to selection, storage, use and maintenance

Specifies storage periods similar to DIN 20066 – bulk hose max. 4 years, a hose assembly max. 2 years. If the storage exceeds these limits the hose must be inspected and tested (tests are not specified). Hose assembly service life is not specified.

## OEM regulations

In addition to these national and international standards, also some Original Equipment Manufacturers (OEMs) have their own regulations for age of hose used for production of hose assemblies.

We recommend generally observe the regulations relevant for your country or ISO 17165-2 (if there is no domestic regulation), plus the regulation of your customer's country or of your OEM customer in the extent in which they are more demanding.

# Hoses storage

## – best practices

Store hoses and hose assemblies in a cool, dark and dry room with capped ends in closed boxes (preferably in the original Parker packaging) and in the manner facilitating inspection of the hose condition and the first-in first-out (FIFO) inventory control system.

The main factors determining the hose storage are:

### a) Temperature

Preferably between 15 °C and 25 °C, without rapid and frequent fluctuation.

### b) Humidity

Preferably not higher than 65 %, protect hose against moisture and avoid atmospheric humidity condensation.

### c) Heat

Store hose away from heat sources.

### d) Light

Protect hose against direct sun light, light of discharge lamps and other ultraviolet sources.

### e) Corrosive liquids and fumes

Do not store in the same room with corrosive chemicals.

### f) Ozone

Avoid using high power electrical equipment and electrical spark sources in the storage room.

### g) Oils and greases

Avoid direct contact.

### h) Space and bends

Keep hose in stress-free shape never bent below the min. bend radius.

### i) Electrical and magnetic fields

Store hose away from powerful electric transformers, motors and generators that could induce current in the hose metal reinforcement.

### j) Rodents and insects

Protect against rodents and insects.

# Fittings storage

## – best practices

For storing fittings the same rules as for hose are applicable (especially for fittings with rubber sealing), in addition:

### a) Mismatching and confusing

Avoid unnecessary repacking and store fittings in clearly marked closed containers (preferably in the original Parker packaging).

### b) Damage of threads and sealing surfaces

Avoid unnecessary reloading and handling.

### c) Fittings with O-rings

Assure that storage period of fittings with O-rings or other rubber sealing does not exceed 2 years (remember: first in-first out).

### d) Caps

Hose assemblies fittings should be capped against damage and contamination.



# Safety First!

A hydraulic hose assembly is a power component and may cause property damage, personal injury or death!

**WARNING: Injuries in which hydraulic or other liquid is involved must be treated without delay and not the same way as an ordinary injury!**

1. High pressure fluid injection can be almost invisible, leaking from a pinhole, but it can pierce the skin deep into the muscle!
2. If a fluid-injection accident occurs, search immediately for a medical treatment by a doctor!
3. Don't touch pressurized hydraulic hose assemblies and don't look at them from a short distance – especially not close to fittings!
4. Secure ends of hydraulic assemblies with high pulsing pressure and all high pressure air hose assemblies against blow-off of the hose from the fitting with appropriate whip restraints!
5. Stay out of hazardous areas while testing hose assemblies under pressure and wear proper protective clothing and goggles!

**We in Parker are making all efforts** to develop, manufacture and deliver defect-free, durable and safe products and services – starting from integrated design and testing of all components through sharing our know-how with our customers and providing them with comprehensive support and training.

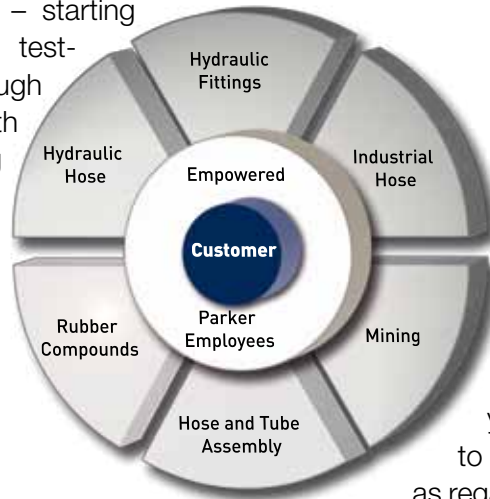

**Please also make all efforts on your side** to provide reliable and safe hose assemblies to your customers and forward to them the know-how you acquired, whether from us or due to your own unique experience, especially as regards the proper use and maintenance of hose assemblies.

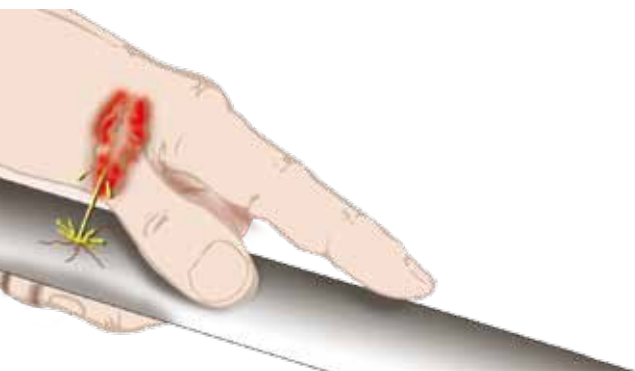

**Avoid injury to yourself and others by following these important rules**



# Carefully read and observe especially the following sections of this catalogue

- For selection of proper hose and fittings:
  - Safe Hose Assembly in 8 Steps (pages **Aa-9** ff)
  - Technical Data (pages **Aa-2** ff)
- For manufacturing of hose assemblies:
  - Working Steps for 1-Piece **Parkrimp No-Skive** Fittings (pages **Aa-12** ff)
  - Working Steps for 2-Piece **ParLock** Fittings (pages **Aa-15** ff)
- For storing, packing and handling:
  - Hose and Fittings Storage (pages **Aa-22** ff)
- For installation on machines:
  - Routing / Installation / Environmental Influences (pages **Aa-17** ff)
- For inspection, maintenance and replacement:
  - Preventive Maintenance Program (page **Aa-26**)
- **READ CAREFULLY AND OBSERVE:**
  - **Parker Safety Guide** for Selecting and Using Hose, Tubing, Fittings and Related Accessories (pages **Ab-42** ff)
- **INVESTIGATE, STUDY AND OBSERVE all relevant international and national standards and directives** of your local trade, technical and work safety associations, such as:
  - **ISO 17165-1** *Hydraulic Fluid Power – Hose Assemblies*
  - **ISO 17165-2** *Hydraulic Fluid Power – Hose Assemblies*
  - **ISO 4413** *Hydraulic fluid power – General rules and safety requirements for systems and their components*
  - **SAE J1273** *Recommended Practices for Hydraulic Hose Assemblies*
- In Germany**
  - **BGR 237** *Hydraulik-Schlauchleitungen – Regeln für den sicheren Einsatz*
  - **FA 015** *Hydraulik-Schlauchleitungen Prüfen und Auswechseln*
  - **BGI 5100** *Sicherheit bei der Hydraulik-Instandhaltung*
- In UK**
  - **BFPDA D8** *Quality Control Procedures and Requirements for BFPDA Distributors*
  - **BFPDA D14** *A Simple Rule for Re-ending Hydraulic Hose Assemblies – Don't*
  - **BFPDA P47** *Guidelines for the Use of Hydraulic Fluid Power Hose and Hose Assemblies*

## Hose Hint

There are several analogies between hydraulic and electric systems and it is not inappropriate to compare high-pressure hydraulic hoses to high-voltage electrical cables and to advise to regard and handle them with similar caution and care!

# Preventive Maintenance Programme

“All hoses will eventually fail, it’s just a matter of when” it is an often ignored but essential fact to remember when working with hydraulic hoses. Moreover, if a hose suddenly fails, it can have direct consequences, including increased labour and

material cost, unscheduled downtime and, most seriously, injury or even death of the personnel close the hose. **Avoiding failure should be a prime directive for any work processes which use hydraulic hoses.**

## Be preventive, not reactive!

A preventive hose maintenance program, including even preventive replacement of not-yet-failed hose assemblies, is far more cost-effective than reacting to a hose assembly failure plus it provides a number of other advantages. It’s essential not to look just at the initial purchase price of a new hose assembly but to the total costs in consequence of a potential failure:

- Cost of lost fluid
- Pollution-related costs
- Costs of other more expensive components damaged due to hose failure
- Machine downtime
- “Costs” related to safety and health – hard to identify and not at all expressible in numbers!



The Preventive Maintenance Program includes a scheduled plan of visual inspections and preventive hose replacement, in case the hose assembly shows signs of an impending failure:

- Damaged, cracked, cut or abraded hose cover
- Exposed reinforcement
- Cracked, damaged or corroded fittings
- Leaks in fitting, perspiring hose cover close to fitting
- Kinked, crushed, flattened or twisted hose
- Hard, stiff, cracked or charred hose
- Blistered, soft, degraded or loose cover
- Fitting slippage on hose
- etc.

### Hose Hint

A good analogy is automobile tyres. Just like hose, tyres are made of rubber, age with time and experience a lot of strain from the conditions they work in. Most drivers are cautious to replace tyres once they show signs of wear, not leaving it to destiny when they break on the road! So why don't they do it with hydraulic hoses?



As there are countless factors influencing the hose life, there cannot be and are not any exact guidelines to determine when a hose assembly has to be replaced or to judge how long it will work. Yet, we do have a tool to influence and determine the hose life:

**Visual Inspections + Preventive Replacement = Preventive Maintenance Program!**

---

# Technical Data

## Technical Data

Hose Overview	Ab-2 – Ab-3
Hose Fittings Overview	Ab-4 – Ab-7
Hose Fittings Pressure Ratings	Ab-8 – Ab-10
Hose Fittings Nomenclature	Ab-11 – Ab-14
Classification Bodies	Ab-15
Classification Body Type Approvals	Ab-16 – Ab-17
Conversion Chart	Ab-18
Temperature / Pressure Chart	Ab-19
Flow Capacity Nomogram	Ab-20
The Correct Method to Fit Female Swivel Ends	Ab-21
Chemical Resistance Table	Ab-22 – Ab-30
Identifying Fitting Types	Ab-31 – Ab-41
Safety Guide	Ab-42 – Ab-45







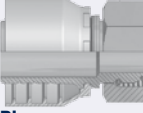

Hose Overview

Hose	Working Pressure (MPa) in Size											Temp.	Construction	Standard	Page				
	-3	-4	-5	-6	-8	-10	-12	-16	-20	-24	-32					-40	-48		
Low pressure	Push-Lok	801Plus	2.4	2.4	2.1	2.1	2.1	2.1	1.4									B1a-1	
		830M	1.6	1.6	1.6	1.6	1.6	1.6	1.6										B1a-4
		831	2.4	2.0	2.0	2.0	2.0	2.0	1.4										B1a-5
		837BM	1.6	1.6	1.6	1.6	1.6	1.6	1.4										B1a-7
		837PU	1.6	1.6	1.6	1.6	1.6	1.6	1.6										B1a-8
	Transport + Hydraulic	Phosphate Ester	1.7	1.7	1.7	1.7	1.7	1.7											B1a-2
		Fire retardant	2.4	2.0	2.0	2.0	2.0	1.7											B1a-3
		High temperature	1.7	1.7	1.7	1.7	1.7	1.7											B1a-6
		Non-conductive	1.6	1.6	1.6	1.6	1.6	1.6											B1a-9
		Standard	601	8.6	7.8	6.9	5.2	3.9											B2a-7
Medium pressure	Transport + Hydraulic	611	2.8	2.8	2.8	2.4	2.1											B2a-8	
		681	7.5	6.8	6.3	5.8	5.0	4.5	4.0									B2a-10	
		611HT	2.8	2.8	2.8	2.4	2.1												B2a-9
		681DB	7.5	6.8	6.3	5.8	5.0	4.5	4.0										B2a-11
		201	20.7	20.7	15.5	13.8	12.0	10.3	5.5	4.3									B2a-1
	High pressure	206	20.7	20.7	15.5	13.8	12.0	10.3	5.5	4.3									B2a-2
		213	13.8	10.3	10.3	8.6	6.9	5.2	2.8	2.1									B2a-3
		293	3.5	3.5	3.5	3.1	3.1	3.1											B2a-6
		221FR		3.5	3.5	3.5	3.5	3.5											B2a-4
		285	3.4	3.4	3.4	3.4	3.4	3.4											B2a-5
Medium pressure	Standard	421SN	22.5	21.5	18.0	16.0	13.0	10.5	8.8	6.3	5.0	4.0						Ca-9	
		422	22.5	21.5	18.0	16.0	13.0	10.5	8.8	6.3	5.0	4.0						Ca-11	
		301SN	40.0	35.0	33.0	27.5	25.0	21.5	16.5	12.5	9.0	8.0						Ca-1	
		302	40.0	35.0	33.0	27.5	25.0	21.5	16.5	12.5	9.0	8.0						Ca-3	
		441	35.0	29.7	28.0	24.5	19.2	15.7	14.0										Ca-15
	High pressure	451	21.0	21.0	21.0	21.0	21.0	21.0											Ca-17
		492	28.0	25.0	22.5	19.0	15.0	11.0	7.5										Ca-26
		462	42.5	40.0	35.0	31.0	28.0	28.0	21.0	17.2									Ca-20
		301TC	40.0	35.0	33.0	27.5	25.0	21.5	16.5	12.5	9.0	8.0							Ca-2
		351TC	28.0	28.0	28.0	28.0	28.0	28.0											Ca-5
Medium pressure	High pressure	451TC	21.0	21.0	21.0	21.0	21.0	21.0											Ca-18
		471TC	40.0	36.0	35.0	29.7	25.0	21.5	17.5										Ca-23
		472TC								15.7	12.5	9.0							Ca-23
		4925T	28.0	25.0	22.5	19.0	15.0	11.0	7.5										Ca-27
		4625T	42.5	40.0	35.0	31.0	28.0	28.0	21.0	17.2									Ca-21
	Low / High temperature	426	19.2	15.7	14.0	10.5	8.7	7.0	4.3										Ca-13
		436	27.5	24.0	19.0	15.5	13.8												Ca-14
		461LT	42.5	40.0	35.0	31.0	28.0	28.0	21.0										Ca-19
		424							6.9	4.3	3.5	2.4							Ca-12
		304	34.5	27.5	24.0		15.5	13.8	11.2	8.6	7.8								Ca-4

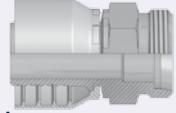
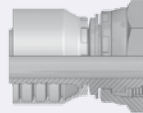
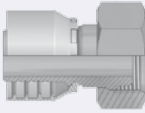

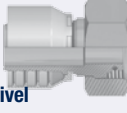

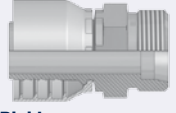
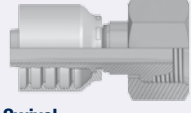
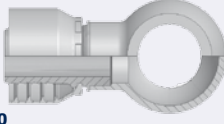
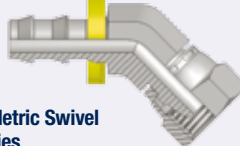



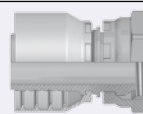
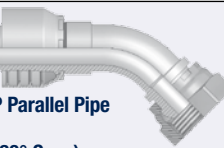

Hose	Working Pressure (MPa) in Size											Temp.	Construction	Standard	Page		
	-3	-4	-5	-6	-8	-10	-12	-16	-20	-24	-32					-40	-48
Medium pressure																	
Railway	35.0	29.7	28.0	24.5	19.2	15.7	14.0									ISO 11237-R16 - SAE 100R16 DIN EN 853-1SN - ISO 1436-1SN/R1AT - SAE 100R1AT	Ca-16 Ca-8
Water cleaning		20.0	20.0	17.5												-	Ca-28 Ca-22
Pilot		10.0	10.0	10.0												-	Ca-6 Ca-7
Wire cover		19.0	15.5	13.8			8.6	6.9								ISO S1436-1SN/R1AT - SAE 100R1AT	Ca-10
Powerlift		45.0	42.5	40.0	38.0	35.0	25.0									Exceeds DIN EN 853-2SN - DIN EN 856-2SC Exceeds DIN EN 853-2SN - DIN EN 856-2SC	Ca-24 Ca-25
Extremely flexible		21.0	21.0	21.0	21.0	21.0										Exceeds SAE 100R17	Ca-29
Suction		21.0	21.0	21.0	21.0	21.0	2.1	1.7	1.4	1.0	0.7	0.4	0.4			Exceeds SAE 100R17 SAE 100R4 SAE 100R4	Ca-30 Ca-31 Ca-32
Standard			44.5	41.5	35.0	28.0										-	Da-2
Low temperature			44.5	41.5	35.0	28.0										-	Da-1
High abrasion res.			44.5	41.5	35.0	28.0										-	Da-4
Railway			44.5	41.5	35.0	28.0										-	Da-3
Standard			45.0	41.5	35.0	28.0				29.0	25.0					DIN EN 856-4SP - ISO 3862-4SP DIN EN 856-4SH - ISO 3862-4SH	Da-5 Da-7
Phosphate Ester				42.0	38.0	35.0	28.0			35.0	35.0					DIN EN 856-R13 - ISO 3862-R13 - SAE 100R13 DIN EN 856-R13 - ISO 3862-R13 - SAE 100R13	Da-11 Da-12
Extreme pressure				42.0	38.0	35.0	28.0			17.5	17.5					ISO 3862-R15 - SAE 100R15	Da-10 Da-17
High abrasion resistance MSHA approved				28.0	28.0	28.0	56.0									-	Da-8
Low temperature			28.0	28.0	28.0	21.0	17.5			17.5	17.5					DIN EN 856-R12 - ISO 3862-R12 - SAE 100R12 DIN EN 856-R13 - ISO 3862-R13 - SAE 100R13	Da-6 Da-13
Compact spiral !			35.0	35.0	35.0	42.0	42.0									ISO 3862-R15 - SAE 100R15 ISO 3862-R15 - SAE 100R15	Da-15 Da-15
Standard		50.0		28.0	28.0	28.0	21.0	17.5								DIN EN 856-R12 - ISO 3862-R12 - SAE 100R12 SAE 100R13 - ISO 3862 Type R13 - ISO 18752-DC SAE 100R15 - ISO 3862 Type R15 - ISO 18752-DC	Da-9 Da-14 Da-16
High abrasion resistance MSHA approved			44.5	41.5	39.0	35.0	31.0			31.0	28.0					Exceeds DIN EN 856-4SP - ISO 3862-4SP Exceeds DIN EN 856-4SH - ISO 3862-4SH	Da-22 Da-18
Extreme abrasion resistance		50.0		44.5	41.5	39.0	35.0	31.0		35.0	35.0	35.0				DIN EN 856-R13 - ISO 3862-R13 - SAE 100R13 ISO 3862-R15 - SAE 100R15	Da-25 Da-27
Railway				44.5	41.5	39.0	35.0	31.0		42.0	42.0	42.0				Exceeds ISO 3862 Type R15	Da-30
High abrasion resistance MSHA approved				43.0	40.0	35.0	31.0			31.0	28.0					Exceeds DIN EN 856-4SP - ISO 3862-4SP Exceeds DIN EN 856-4SH - ISO 3862-4SH	Da-23 Da-20
Extreme abrasion resistance				42.0	42.0	42.0	42.0	42.0		42.0	42.0	35.0				DIN EN 856-R13 - ISO 3862-R13 - SAE 100R13 ISO 3862-R15 - SAE 100R15	Da-26 Da-28
Railway				50.0	50.0	50.0	50.0			42.0	42.0	42.0				Exceeds ISO 3862 Type R15	Da-30
High abrasion resistance				44.5	41.5	39.0	35.0	31.0		35.0	31.0	28.0				Exceeds DIN EN 856-4SP - ISO 3862-4SP Exceeds DIN EN 856-4SH - ISO 3862-4SH	Da-24 Da-21
Extreme abrasion resistance				42.0	42.0	42.0	42.0	42.0		42.0	42.0	42.0				ISO 3862-R15 - SAE 100R15	Da-29
Railway				40.0	40.0	40.0	40.0			31.0	31.0					Exceeds DIN EN 856-4SH - ISO 3862-4SH	Da-19

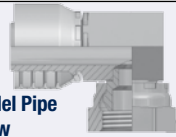
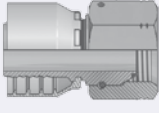

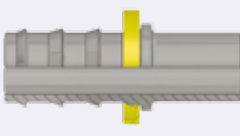

## DIN – Metric

<p><b>CA</b></p>  <p>Female Metric 24° Light Series with O-Ring Swivel – Straight ISO 12151-2-SWS-L – DKOL</p>	<p><b>CE</b></p>  <p>Female Metric 24° Light Series with O-Ring Swivel – 45° Elbow ISO 12151-2-SWE 45°-L – DKOL 45°</p>	<p><b>CF</b></p>  <p>Female Metric 24° Light Series with O-Ring Swivel – 90° Elbow ISO 12151-2-SWE-L – DKOL 90°</p>	<p><b>D0</b></p>  <p>Male Metric 24° Light Series – Rigid Straight ISO 12151-2-S-L – CEL</p>
<p><b>C0</b></p>  <p>Female Metric Very Light Series LL Swivel – Straight (Ball Nose) DKM</p>	<p><b>C3</b></p>  <p>Female Metric Light Series – Swivel Straight (Ball Nose) DKL</p>	<p><b>C4</b></p>  <p>Female Metric Light Series – Swivel 45° Elbow (Ball Nose) DKL 45°</p>	<p><b>C5</b></p>  <p>Female Metric Light Series – Swivel 90° Elbow (Ball Nose) DKL 90°</p>
<p><b>C9</b></p>  <p>Female Metric 24° – Swivel Heavy Series with O-Ring Straight ISO 12151-2-SWS-S – DKOS</p>	<p><b>0C</b></p>  <p>Female Metric 24° – Swivel Heavy Series with O-Ring 45° Elbow ISO 12151-2 – SWE 45°-S – DKOS 45°</p>	<p><b>1C</b></p>  <p>Female Metric 24° – Swivel Heavy Series with O-Ring 90° Elbow ISO 12151-2-SWE-S – DKOS 90°</p>	<p><b>D2</b></p>  <p>Male Metric 24° – Rigid Heavy Series – Straight ISO 12151-2-S-S – CES</p>
<p><b>C6</b></p>  <p>Female Metric – Swivel Heavy Series – Straight (Ball Nose) DKS</p>	<p><b>49</b></p>  <p>Metric Banjo Straight DIN 7642</p>	<p><b>9B</b></p>  <p>Female Metric Swivel Light Series 45° Elbow</p>	<p><b>9C</b></p>  <p>Female Metric Swivel Light Series 90° Elbow</p>



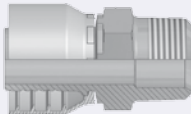

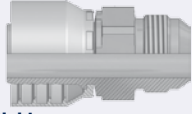
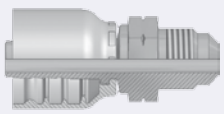
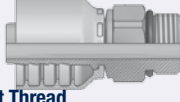
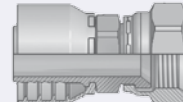
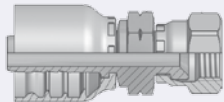
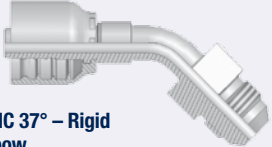
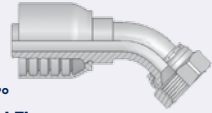
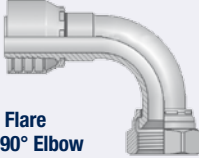





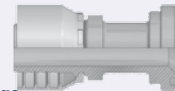

## BSP

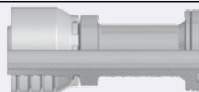
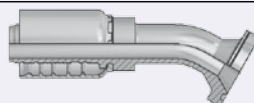
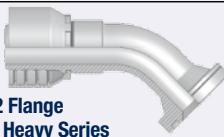
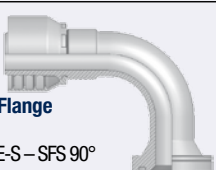
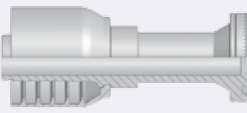
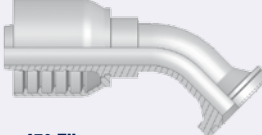
<p><b>92</b></p>  <p>Female BSP Parallel Pipe Swivel – Straight (60° Cone) BS5200-A – DKR</p>	<p><b>B1</b></p>  <p>Female BSP Parallel Pipe Swivel 45° Elbow (60° Cone) BS 5200-D – DKR 45°</p>	<p><b>B2</b></p>  <p>Female BSP Parallel Pipe Swivel 90° Elbow (60° Cone) BS 5200-B – DKR 90°</p>	<p><b>B4</b></p>  <p>Female BSP Parallel Pipe Swivel – 90° Elbow Block Type (60° Cone) BS 5200-E – DKR 90°</p>
<p><b>EA</b></p>  <p>BSP Swivel Female with O-Ring (60° Cone) BS 5200 – ISO 12151-6 – DKOR</p>	<p><b>EB</b></p>  <p>BSP Swivel Female with O-Ring 45° Elbow (60° Cone) BS 5200 – ISO 12151-6 – DKOR 45°</p>	<p><b>EC</b></p>  <p>BSP Swivel Female with O-Ring 90° Elbow (60° Cone) BS 5200 – ISO 12151-6 – DKOR 90°</p>	<p><b>D9</b></p>  <p>Male BSP Parallel Pipe Rigid – Straight (60° Cone) BS5200 – AGR</p>
<p><b>91</b></p>  <p>Male BSP Taper Pipe – Rigid Straight BS5200 – AGR-K</p>	<p><b>B5</b></p>  <p>Female BSP Parallel Pipe Swivel Straight (Flat Seat)</p>	<p><b>34</b></p>  <p>Inch Standpipe (Brass)</p>	



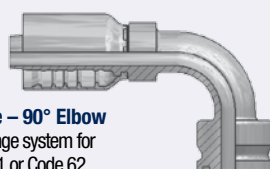
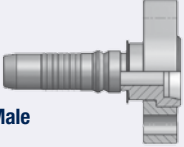
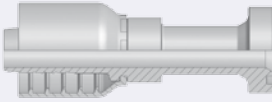

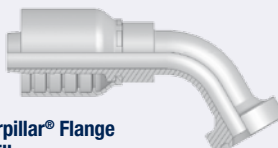
# SAE

<p><b>01</b></p>  <p><b>Male NPTF Pipe Rigid – Straight</b> SAE J476A / J516 – AGN</p>	<p><b>02</b></p>  <p><b>Female NPTF Pipe – Rigid Straight</b> SAE J476A / J516</p>	<p><b>03</b></p>  <p><b>Male JIC 37° – Rigid Straight</b> ISO12151-5-S – AGJ</p>	<p><b>04</b></p>  <p><b>Male SAE 45° – Rigid Straight</b> SAE J516</p>
<p><b>05</b></p>  <p><b>Male SAE Straight Thread with O-Ring – Rigid Straight</b> ISO 11926 – SAE J516</p>	<p><b>06/68</b></p>  <p><b>Female – JIC 37° SAE 45° Dual Flare Swivel – Straight</b> ISO12151-5-SWS – DKJ</p>	<p><b>08</b></p>  <p><b>Female SAE 45° – Swivel Straight</b> SAE J516</p>	<p><b>33</b></p>  <p><b>Male JIC 37° – Rigid 45° Elbow</b> ISO 12151-5 – AGJ 45°</p>
<p><b>37/3V</b></p>  <p><b>Female JIC 37° SAE 45° – Dual Flare Swivel Female 45° Elbow</b> ISO 12151-5-SWE 45° – DKJ 45°</p>	<p><b>39/3W</b></p>  <p><b>Female JIC 37° SAE 45° – Dual Flare Swivel Female 90° Elbow</b> ISO 12151-5-SWES – DKJ 90°</p>	<p><b>41/3Y</b></p>  <p><b>Female JIC 37° / 45° Swivel Female 90° Elbow (Long)</b> ISO 12151-5-SWEL – DKJ 90°L</p>	<p><b>L9</b></p>  <p><b>Female JIC 37° – Swivel 90° Elbow – Medium Drop</b> ISO 12151-5-SWEM – DKJ 90° M</p>

# Flange

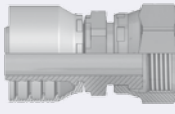
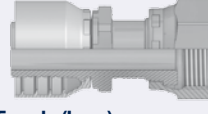
<p><b>15/4A</b></p>  <p><b>SAE Code 61 Flange Straight</b> ISO 12151-3-S-L – SFL 5000 psi</p>	<p><b>16</b></p>  <p><b>SAE Code 61 – Flange Head 22.5° Elbow</b> ISO 12151-3-E22ML – SFL 22.5° 3000 psi</p>	<p><b>17/4F</b></p>  <p><b>SAE Code 61 Flange 45° Elbow</b> ISO 12151-3 – E45S – L – SFL 45° 5000 psi</p>	<p><b>19/4N</b></p>  <p><b>SAE Code 61 Flange 90° Elbow</b> ISO 12151-3-E-L – SFL 90° 5000 psi</p>
<p><b>6A</b></p>  <p><b>SAE Code 62 Flange Straight</b> ISO 12151-3-S-S – SFS 6000 psi</p>	<p><b>6E</b></p>  <p><b>SAE Code 62 Flange 30° Elbow</b> SFS 30°</p>	<p><b>6F</b></p>  <p><b>SAE Code 62 Flange 45° Elbow – Heavy Series</b> ISO 12151-3 – E45-S – SFS 45° 6000 psi</p>	<p><b>6N</b></p>  <p><b>SAE Code 62 Flange 90° Elbow</b> ISO 12151-3 – E-S – SFS 90° 6000 psi</p>
<p><b>8A</b></p>  <p><b>Flange – Straight</b> 8000 psi</p>	<p><b>8F</b></p>  <p><b>Flange – 45° Elbow</b> 8000 psi</p>	<p><b>8N</b></p>  <p><b>Flange – 90° Elbow</b> 8000 psi</p>	<p><b>X5</b></p>  <p><b>Flange – Straight</b> Full flange system for Code 61 or Code 62</p>
<p><b>X7</b></p>  <p><b>Flange – 45° Elbow</b> Full flange system for Code 61 or Code 62</p>	<p><b>X9</b></p>  <p><b>Flange – 90° Elbow</b> Full flange system for Code 61 or Code 62</p>	<p><b>PY</b></p>  <p><b>Flange – 24° Male French Gas Straight</b></p>	<p><b>XA</b></p>  <p><b>Caterpillar® Flange Straight</b></p>
<p><b>XF</b></p>  <p><b>Caterpillar® Flange 45° Elbow</b></p>	<p><b>XG</b></p>  <p><b>Caterpillar® Flange 60° Elbow</b></p>	<p><b>XN</b></p>  <p><b>Caterpillar® Flange 90° Elbow</b></p>	

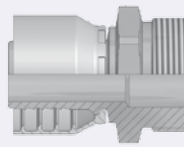
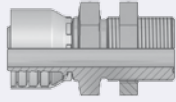

## ORFS

<p><b>JC</b></p>  <p>Female ORFS Swivel – Straight Short ISO 12151-1 – SWSA SAE J516 – ORFS</p>	<p><b>JS</b></p>  <p>ORFS Swivel Female (Long) ISO 12151-1-SWSB SAE J516 – ORFS</p>	<p><b>J7</b></p>  <p>Female ORFS – Swivel 45° Elbow ISO 12151-1 – SWE 45° SAE J516 – ORFS 45°</p>	<p><b>J9</b></p>  <p>Female ORFS – Swivel 90° Elbow – Short Drop ISO 12151-1 – SWES SAE J516 – ORFS 90°</p>
<p><b>J1</b></p>  <p>Female ORFS – Swivel 90° Elbow – Long Drop ISO 12151-1 – SWEL SAE J516 – ORFS 90° L</p>	<p><b>J5</b></p>  <p>Female ORFS – Swivel 90° Elbow – Medium Drop ISO 12151-1 – SWEM – ORFS 90° M</p>	<p><b>JM</b></p>  <p>ORFS Male ISO 12151-1-S – SAE J516</p>	<p><b>JD</b></p>  <p>Male ORFS Bulkhead with Locknut Straight (with O-ring) ISO 12151-1 – SAE J516</p>

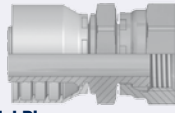
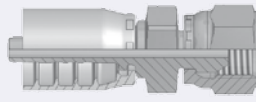
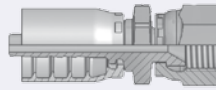
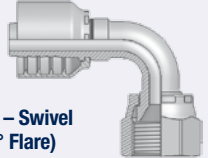
## JIS

<p><b>FU</b></p>  <p>Female BSP Parallel Pipe Swivel – Straight (30° Flare) ISO 228-1 – JIS B8363 – GUI</p>	<p><b>GU</b></p>  <p>Female BSP Parallel Pipe Swivel – Straight (60° Cone) ISO 228-1 – JIS B8363 – GUO</p>	<p><b>MU</b></p>  <p>Female Metric – Swivel Straight (30° Flare) JIS B8363 – MU</p>	<p><b>MZ</b></p>  <p>Female Metric – Swivel 90° Elbow (30° Flare) JIS B8363</p>
--	---	---	---

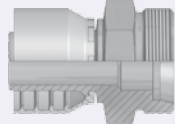

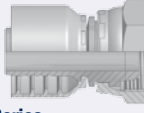
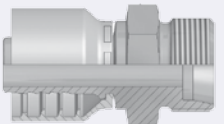
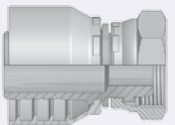
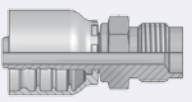



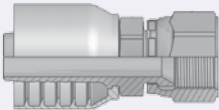
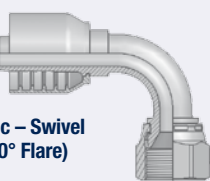
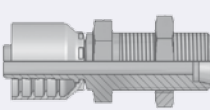
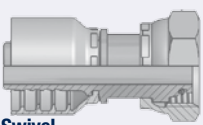
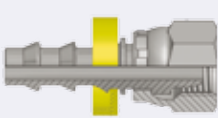
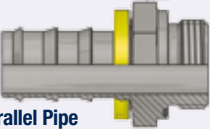

## French Standard

<p><b>FG</b></p>  <p>Male French Gas Series Rigid – Straight (24° Cone)</p>	<p><b>F2</b></p>  <p>Female French Gas Series Swivel – 90° Elbow</p>	<p><b>F4</b></p>  <p>Female French Gas Series Swivel – Straight (Ball Nose)</p>	<p><b>F6</b></p>  <p>French Male Metric Series (24° Cone)</p>
<p><b>F9</b></p>  <p>French Female Metric Series Swivel – (Ball Nose)</p>	<p><b>FA</b></p>  <p>Metric Male for Agriculture Valves</p>		

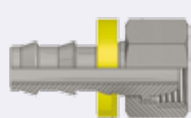
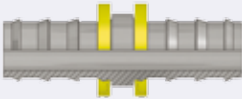
## High Pressure Cleaning

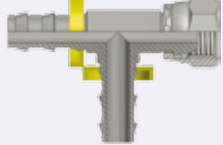
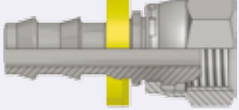
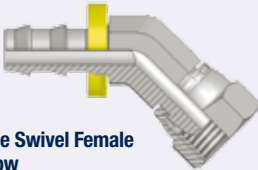
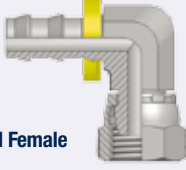
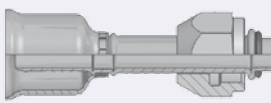
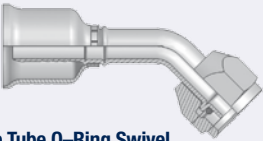
<p><b>CW</b></p>  <p>Power Cleaner Connection</p>	<p><b>NW</b></p>  <p>Female Kärcher Metric Cleaning Hose Fitting Swivel – Straight</p>	<p><b>PW</b></p>  <p>Male Kärcher Metric Cleaning Hose Fitting Rigid – Straight</p>
--	---	---

# Others

<p><b>XU</b></p>  <p>Female Metric – Swivel Straight (30° Flare) JIS B8363</p>	<p><b>XY</b></p>  <p>Female Metric – Swivel 90° Elbow (30° Flare) JIS B8363</p>	<p><b>DK</b></p>  <p>Male Metric L – Rigid Bulkhead with Locknut (24° Cone)</p>	<p><b>DX</b></p>  <p>Female Metric Swivel (M27x2) O-Ring Light Series</p>
<p><b>FF</b></p>  <p>Metru-Lok Swivel Female</p>	<p><b>AF</b></p>  <p>Male BSP Parallel Pipe Rigid – Straight (with O-ring Seal)</p>	<p><b>NM</b></p>  <p>Male BSP Parallel Pipe L Series – Rigid – Straight ED-Seal ISO 1179</p>	<p><b>VW121</b></p>  <p>BSP Swivel Female (WW-Norm 39-V-16631)</p>
<p><b>82</b></p>  <p>Push-Lok® Union</p>	<p><b>DP</b></p>  <p>Metric Swivel Female Tee Male Stud</p>	<p><b>DR</b></p>  <p>Metric Swivel Female Tee</p>	<p><b>5C</b></p>  <p>60° Cone Swivel Female</p>
<p><b>6C</b></p>  <p>60° Cone Swivel Female 45° Elbow</p>	<p><b>7C</b></p>  <p>60° Cone Swivel Female 90° Elbow</p>	<p><b>5S</b></p>  <p>Female Tube O-ring Swivel Short Pilot</p>	<p><b>5H</b></p>  <p>Female Tube O-Ring Swivel 45° Elbow – Short Pilot</p>
<p><b>5T</b></p>  <p>Female Tube O-Ring Swivel 90° Elbow – Short Pilot</p>	<p><b>59PT</b></p>  <p>Male Tube O-Ring Swivel Long Pilot With Charge Port at 180° for R134a</p>	<p><b>5LPT</b></p>  <p>Female Tube O-Ring Swivel 90° Elbow – Long Pilot With Charge Port at 180° for R134a</p>	

## UPTC Universal push-to-connect

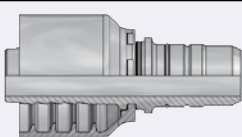
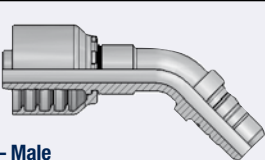
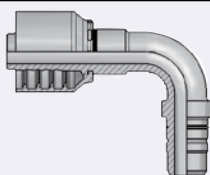
<p><b>EN</b></p>  <p>UPTC – Male Straight</p>	<p><b>EU</b></p>  <p>UPTC – Male 45° Elbow</p>	<p><b>ET</b></p>  <p>UPTC – Male 90° Elbow</p>
--	---	--

# Hose Fittings Pressure Ratings

Fitting end connection	Description	Inch fittings (size) Maximum working pressure (MPa) – safety factor 4:1									
		-4	-5	-6	-8	-10	-12	-16	-20	-24	-32
92, B1, B2, B5	BSP swivel female	63.0		55.0	43.0	37.5	35.0	28.0	25.0	21.0	21.0
B4	BSP swivel female	35.0	35.0	35.0	35.0	35.0	35.0	28.0	25.0	21.0	21.0
EA, EB, EC	BSP swivel female with O-ring	40.0		40.0	35.0	35.0	31.5	25.0	20.0	16.0	12.5
91, D9	BSP male	63.0		55.0	43.0		35.0	28.0	25.0	21.0	21.0
01	NPTF male	34.5		27.5	24.0		21.0	17.0	15.0	14.0	14.0
02	NPTF female	34.5		27.5	24.0		21.0	17.0	15.0	14.0	14.0
03, 33	SAE (JIC) 37° male	41.0	41.0	34.5	34.5	34.5	34.5	27.5	20.0	17.0	17.0
04	SAE 45° male	41.0	41.0	34.5	34.5	34.5	34.5	27.5	20.0	17.0	17.0
05	SAE male with O-ring	41.0	41.0	34.5	34.5	34.5	34.5	27.5	20.0	17.0	17.0
06/68,37/3V, 39/3W, L9, 41/3Y	SAE (JIC) 37° swivel female	41.0	41.0	34.5	34.5	34.5	34.5	27.5	20.0	17.0	17.0
93	Female SAE (JIC) 37° 90° Elbow	41.4	41.0	34.5	34.5	34.5	34.5	27.5	20.0	17.0	17.0
07	Female NPSM-pipe swivel	34.5		27.5	24.0		21.0	17.0			
08, 77, 79	Female SAE 45° swivel	41.0	41.0	34.5	34.5	34.5	34.5	27.5	20.0	17.0	17.0
1L	Male NPTF pipe swivel 90° Elbow	21.0	21.0	21.0	21.0	19.0	15.5	14.0	11.0	9.0	8.0
S2	Female NPTF pipe swivel	21.0	21.0	21.0	21.0	19.0	15.5	14.0	11.0	9.0	8.0
0G, 0L	Male SAE O-ring	21.0	21.0	21.0	21.0	19.0	15.5	14.0	11.0	9.0	8.0
28, 67, 69	SAE Male inverted 45° swivel	19.0	17.0	15.0	14.0						
15, 16, 17, 18, 19, 26, 27, 89, X5, X7, X9	SAE flange Code 61				34.5	34.5	34.5	34.5	27.5	21.0	21.0
4A, 4N, 4F	SAE flange 5000 psi								34.5	34.5	34.5
6A, 6E, 6F, 6G, 6N, XA, XF, XG, XN, X5, X7, X9	SAE flange Code 62 6000 psi				41.0		41.0	41.0	41.0	41.0	41.0
8A, 8F, 8N	SAE flange 8000 psi					55.0	55.0	55.0	55.0		

Fitting end connection	Description	Inch fittings (size)									
		Maximum working pressure (MPa) – safety factor 4:1									
		-4	-5	-6	-8	-10	-12	-16	-20	-24	-32
JM, J6, J8, J0, JU	ORFS male	41.0		41.0	41.0	41.0	41.0	41.0	27.5	27.5	
JC, JS, J3, J7, J9, J5, J1	ORFS swivel female	41.0		41.0	41.0	41.0	41.0	41.0	27.5	27.5	
JD	Male ORFS Bulkhead with Locknut with O-ring	41.0		41.0	41.0	41.0	41.0	41.0	27.5	27.5	
GU	JIS / BSP swivel female 60° cone	35.0	35.0	35.0	35.0	28.0	28.0	21.0	17.5		
FU	Female JIS / BSP 30° parallel pipe swivel	35.0	35.0	35.0	35.0	28.0	28.0	21.0	17.5		
MU	JIS 30° metric swivel female	35.0	35.0	35.0	35.0	28.0	28.0	21.0	17.5		
MZ	Metric swivel female 90° Elbow	35.0	35.0	35.0	35.0	28.0	28.0	21.0	17.5		
UT	JIS / BSP male 60° cone	35.0		35.0	35.0		28.0	21.0	17.5		
V1	Banjo soft seal with UNF bolt	25.0	25.0		21.5	21.5	20.0				
V3	Banjo soft seal with BSPP bolt	25.0	25.0		21.5	21.5	20.0				
XU, XY	Female Metric swivel 30° Flare	35.0	35.0	35.0	35.0	28.0	28.0	21.0	17.5		

Fitting end connection	Description	Metric tube (mm) • Light series – L									
		Maximum working pressure (MPa) – safety factor 4:1									
		6	8	10	12	15	18	22	28	35	42
C3, C4, C5	Swivel female Form A	25.0	25.0	25.0	25.0	25.0	16.0	16.0	10.0	10.0	10.0
CA, CE, CF	DIN 20066 swivel female with O-ring, Form N	31.5	42.5	40.0	35.0	31.5	31.5	28.0	21.0	16.0	16.0
DO, DF, DG, DK	DIN 20066 male stud, Form D	25.0	42.5	40.0	35.0	31.0	28.0	28.0	21.0	16.0	16.0
DX	Metric swivel female with O-ring	31.5	42.5	40.0	35.0	31.5	31.5	28.0	21.0	16.0	16.0
1D, DD, 5D	Metric standpipe	25.0	25.0	25.0	25.0	25.0	16.0	16.0	10.0	10.0	10.0
CW, NW	High pressure cleaning hose connection					40.0					
PW	High pressure cleaning hose connection			22.5							
EN, ET, EU	Universal push-in connector		40.0	35.0	35.0	29.5	28.0	21.5			

Fitting end connection	Description	Metric tube (mm) • Very light series – LL									
		Maximum working pressure (MPa) – safety factor 4:1									
		8	10	12	15	18	22	28	35	42	50
C0	DIN 20066 swivel female DKLL						6.3	6.3	6.3	6.3	4.0

Fitting end connection	Description	Metric tube (mm) • Metric										
		Maximum working pressure (MPa) – safety factor 4:1										
		6	8	10	12	14	16	18	20	22	25	27
49	Metric Banjo - straight (DIN 7642)	20.0	20.0	20.0	20.0	20.0	20.0	20.0	20.0	20.0	20.0	
V2	Banjo soft seal with metric bolt				25.0	25.0		21.5		21.5		20.0

Fitting end connection	Description	Metric tube (mm) • Heavy series – S									
		Maximum working pressure (MPa) – safety factor 4:1									
		6	8	10	12	14	16	20	25	30	38
C6, C7, C8	Swivel female	63.0	63.0	63.0	63.0	63.0	40.0	40.0	40.0	25.0	25.0
C9, 0C, 1C	Swivel female DIN 20066:2002-10 with O-ring, Form P	63.0	63.0	63.0	63.0	63.0	42.0	42.0	42.0	42.0	42.0
D2	Male stud	63.0	63.0	63.0	63.0	63.0	42.0	42.0	42.0	42.0	42.0
3D	Metric standpipe	63.0	63.0	63.0	63.0	63.0	40.0	40.0	40.0	25.0	25.0

Fitting end connection	Description	Metric tube (mm) • French gas series				
		Maximum working pressure (MPa) – safety factor 4:1				
		13	17	21	27	33
F2	Swivel female 90° Elbow	36.0	27.0	25.5	20.0	17.0
F4	Swivel female (Ball Nose)	36.0	27.0	25.5	20.0	17.0
FG	Male stud	36.0	27.0	25.5	20.0	17.0
GE	Metric standpipe	36.0	27.0	25.5	20.0	17.0

Fitting end connection	Description	Metric tube (mm) • French metric series						
		Maximum working pressure (MPa) – safety factor 4:1						
		10	12	14	18	20	22	30
F9	Swivel female	20.0		14.0	16.0	14.0	13.0	12.2
F6	Male agricultural valves	20.0		14.0	16.0	14.0	13.0	12.2
FA	Male agricultural valves		25.0					



## Hose Fittings Nomenclature

End Configuration	Description	Standards	Common Terms
01	Male NPTF Pipe – Rigid – Straight	SAE J476A / J516	AGN
02	Female NPTF Pipe – Rigid – Straight	SAE J476A / J516	
03	Male JIC 37° – Rigid – Straight	ISO12151-5-S	AGJ
04	Male SAE 45° – Rigid – Straight	SAE J516	
05	Male SAE Straight Thread with O-ring – Rigid – Straight	ISO 11926, SAE J516	
06	Female JIC 37° Swivel – Straight	ISO12151-5-SWS	DKJ
06/68	Female – JIC 37° / SAE 45° Dual Flare – Swivel – Straight	ISO12151-5-SWS	DKJ
07	Female NPSM Pipe Swivel		
08	Female SAE 45° – Swivel – Straight	SAE J516	
0C	Female Metric 24° – Heavy Series with O-ring – Swivel – 45° Elbow	ISO 12151-2 – SWE 45°-S	DKOS 45°
0G	Male O-ring Straight		
0L	Male O-ring 90° Elbow		
11	„Ferrul-Fix“		
12	Female SAE Flareless Swivel – Straight (24° Cone)		
13	Male NPTF Pipe Swivel	SAE J476A / J516	
15	SAE Code 61 – Flange Head – Straight	ISO 12151-3-S-L	SFL / 3000 psi
15/4A	SAE Code 61 – Flange Head – Straight / SAE Flange Head 5000 psi	ISO 12151-3-S-L	SFL
16	SAE Code 61 – Flange Head – 22.5° Elbow	ISO 12151-3-E22ML	SFL 22.5° / 3000 psi
17	SAE Code 61 – Flange Head – 45° Elbow	ISO 12151-3 – E45 – L	SFL 45° / 3000 psi
17/4F	SAE Code 61 – Flange – 45° Elbow – 45° Elbow (5000 psi)	ISO 12151-3 – E45S – L	SFL 45°
18	SAE Code 61 – Flange – 67.5° Elbow		SFL 67.5°
19	SAE Code 61 – Flange Head – 90° Elbow	ISO 12151-3 – E– L	SFL 90° / 3000 psi
19/4N	SAE Code 61 – Flange Head – 90° Elbow (5000 psi)	ISO 12151-3-E-L	SFL 90°
1C	Female Metric 24° – Heavy Series with O-ring – Swivel – 90° Elbow	ISO 12151-2-SWE-S	DKOS 90°
1D	Metric Standpipe – Light Series – Rigid – Straight	ISO 8434-1	BEL
1L	Male NPTF Pipe Swivel – 90° Elbow		
26	SAE Code 61 Flange – 30° Elbow		SFL 30°
27	SAE Code 61 Flange – 60° Elbow		SFL 60°
28	SAE Male Inverted 45° Elbow		
33	Male JIC 37° – Rigid – 45° Elbow	ISO 12151-5	AGJ 45°
34	Inch Standpipe (Brass)		
37	Female JIC 37° – Swivel – 45° Elbow	ISO 12151-5-SWE 45°	DKJ 45°
37/3V	Female JIC 37° /SAE 45° – Dual Flare – Swivel Female 45° Elbow	ISO 12151-5-SWE 45°	DKJ 45°
39	Female JIC 37° – Swivel – 90° Elbow	ISO 12151-5-SWES	DKJ 90°
39/3W	Female JIC 37° / SAE 45° – Dual Flare – Swivel Female 90° Elbow	ISO 12151-5-SWES	DKJ 90°
3D	Metric Standpipe – Heavy Series – Rigid – Straight	ISO 8434-1	BES
3V	Female JIC 37°/SAE – 45° Swivel – 45° Elbow		DKJ 45°
3W	Female JIC 37°/SAE – 45° Swivel – 90° Elbow		DKJ 90°
3Y	Female JIC 37°/SAE – 45° Swivel – 90° Elbow (Long)		DKJ 90°
41	Female JIC 37° Swivel – 90° Elbow (Long)		DKJ 90°
41/3Y	Female JIC 37° / 45° Swivel Female 90° Elbow (Long)	ISO 12151-5-SWEL	DKJ 90°L
45	Male Tube O-ring Swivel – Long Pilot		

End Configu- ration	Description	Standards	Common Terms
49	Metric Banjo – Straight	DIN 7642	
4A	5000 psi SAE Code 61 – Flange – Straight		
4F	5000 psi SAE Code 61 – Flange – 45° Elbow		
4N	5000 psi SAE Code 61 – Flange – 90° Elbow		
59	Female Tube O-ring Swivel – Long Pilot		
59PT	Male Tube O-ring Swivel – Long Pilot	With Charge Port at 180° for 134a	
5C	60° Cone Swivel Female		
5D	Metric Standpipe – Light Series – Rigid – 90° Elbow	ISO 8434-1	BEL 90°
5G	Male Tube O-ring Rigid Port (3 step) Straight		
5GPR	Female Tube O-ring Rigid Port (3 step) Straight	With Charge Port for R12	
5H	Female Tube O-ring Swivel – 45° Elbow – Short Pilot		
5K	Male Tube O-ring Swivel – 90° Elbow – Short Pilot		
5LPR	Female Tube O-ring Swivel – 90° Elbow – Long Pilot		
5LPT	Female Tube O-ring Swivel – 90° Elbow – Long Pilot	With Charge Port at 180° for 134a	
5MPR	Male Tube O-ring Swivel – 90° Elbow – Long Pilot	With Charge Port at 180° for R12	
5MPV	Male Tube O-ring Swivel – 90° Elbow – Long Pilot	With Charge Port at 270° for 134a	
5N	Female Tube O-ring Swivel – 45° Elbow – Long Pilot		
5P	Female Tube O-ring Swivel – 45° Elbow – Long Pilot		
5R	Male Tube O-ring Swivel – 45° Elbow – Short Pilot		
5S	Female Tube O-ring Swivel – Short Pilot		
5T	Female Tube O-ring Swivel – 90° Elbow – Short Pilot		
5V	Female Compressor – Swivel 45° Elbow		
5W	Female Compressor – Swivel 90° Elbow		
5Z	Female Compressor – Swivel 90° Elbow – Block Type		
67	SAE Male Inverted Flare Swivel – 45° Elbow		
68	Female JIC 37° / SAE 45° Swivel		DKJ
69	SAE Male Inverted Flare Swivel – 90° Elbow		
6A	SAE Code 62 – Flange – Straight	ISO 12151-3-S-S	SFS / 6000 psi
6B	SAE Code 62 – Flange – 22.5° Elbow		SFS 22.5°
6C	60° Cone Swivel Female – 45° Elbow		
6E	SAE Code 62 – Flange – 30° Elbow		SFS 30°
6F	SAE Flange 45° Elbow – Heavy Series	ISO 12151-3 – E45-S	SFS 45° / 6000 psi
6G	SAE Code 62 – Flange – 60° Elbow		SFS 60°
6N	SAE Code 62 – Flange – 90° Elbow	ISO 12151-3 – E-S	SFS 90° / 6000 psi
77	Female SAE 45° Swivel – 45° Elbow		
79	Female SAE 45° Swivel – 90° Elbow		
7C	60° Cone Swivel Female – 90° Elbow		
7D	Male Standpipe Metric S – Rigid – 90° Elbow		BES 90°
82	Push-Lok® Union		
89	SAE Code 61 – Flange – 90° Elbow (Long) – Standard Series		
8A	Flange – Straight – 8000 psi		
8F	Flange – 45° Elbow – 8000 psi		
8N	Flange – 90° Elbow – 8000 psi		
91	Male BSP Taper Pipe – Rigid – Straight	BS5200	AGR-K

End Configuration	Description	Standards	Common Terms
92	Female BSP Parallel Pipe – Swivel – Straight (60° Cone)	BS5200-A	DKR
93	Female JIC 37° – Swivel – 90° Elbow (Block Type)		
9B	Metric – Swivel Female 45° Elbow – Light Series		
9C	Light Series Metric Swivel Female 90° Elbow		
AF	Male BSP Parallel Pipe – Rigid – Straight (with O-ring Seal)		
B1	Female BSP Parallel Pipe – Swivel – 45° Elbow (60° Cone)	BS 5200-D	DKR 45°
B2	Female BSP Parallel Pipe – Swivel – 90° Elbow (60° Cone)	BS 5200-B	DKR 90°
B4	Female BSP Parallel Pipe – Swivel – 90° Elbow Block Type (60° Cone)	BS 5200-E	DKR 90°
B5	Female BSP Parallel Pipe – Swivel – Straight (Flat Seat)		
C0	Female Metric – Very Light Series LL – Swivel – Straight (Ball Nose)		DKM
C3	Female Metric – Light Series – Swivel – Straight (Ball Nose)		DKL
C4	Female Metric – Light Series – Swivel – 45° Elbow (Ball Nose)		DKL 45°
C5	Female Metric – Light Series – Swivel – 90° Elbow (Ball Nose)		DKL 90°
C6	Female Metric – Heavy Series – Swivel – Straight (Ball Nose)		DKS
C7	Female Metric Swivel – 45° Elbow “Heavy” Series		DKS 45°
C8	Female Metric Swivel – 90° Elbow “Heavy” Series		DKS 90°
C9	Female Metric 24° – Heavy Series with O-ring – Swivel – Straight	ISO 12151-2-SWS-S	DKOS
CA	Female Metric 24° – Light Series with O-ring – Swivel – Straight	ISO 12151-2-SWS-L	DKOL
CE	Female Metric 24° – Light Series with O-ring – Swivel – 45° Elbow	ISO 12151-2-SWE 45°-L	DKOL 45°
CF	Female Metric 24° – Light Series with O-ring – Swivel – 90° Elbow	ISO 12151-2-SWE-L	DKOL 90°
CW	Power Cleaner Connection		
D0	Male Metric 24° – Light Series – Rigid – Straight	ISO 12151-2-S-L	CEL
D2	Male Metric 24° – Heavy Series – Rigid – Straight	ISO 12151-2-S-S	CES
D9	Male BSP Parallel Pipe – Rigid – Straight (60° Cone)	BS5200	AGR
DD	Metric Standpipe – Light Series – Rigid – 45° Elbow		BEL 45°
DE	Double Banjo Union		
DK	Male Metric L – Rigid – Bulkhead with Locknut (24° Cone)		
DP	Metric Swivel Female Tee / Male Stud		
DR	Metric Swivel Female Tee		
DS	Metric Swivel Female Tee / Standpipe		
DW	Female Metric Swivel „Light“ Series		TGL
DX	Female Metric Swivel (M27x2) O-ring – Light Series		
EA	BSP Swivel Female with O-ring (60° Cone)	BS 5200, ISO 12151-6	DKOR
EB	BSP Swivel Female with O-ring – 45° Elbow (60° Cone)	BS 5200, ISO 12151-6	DKOR 45°
EC	BSP Swivel Female with O-ring – 90° Elbow (60° Cone)	BS 5200, ISO 12151-6	DKOR 90°
EN	UPTC – Male – Straight		
ET	UPTC – Male – 90° Elbow		
EU	UPTC – Male – 45° Elbow		
F2	Female French Swivel Female – Gas Series 90° Elbow		
F4	Female French Gas Series – Swivel – Straight (Ball Nose)		
F6	French Male Metric Series (24° Cone)		
F9	French Swivel Female Metric Series – (Ball Nose)		
FA	Metric Male For Agriculture Valves		
FB	French Metric		

End Configu- ration	Description	Standards	Common Terms
FF	Metru-Lok Swivel Female		
FG	Male French Gas Series – Rigid – Straight (24° Cone)		
FU	Female BSP Parallel Pipe – Swivel – Straight (30° Flare)	ISO 228-1, JIS B8363	GUI
GE	French Gas Standpipe		
GU	Female BSP Parallel Pipe – Swivel – Straight (60° Cone)	ISO 228-1, JIS B8363	GUO
J1	Female ORFS – Swivel – 90° Elbow – Long Drop	ISO 12151-1 – SWEL, SAE J 516	ORFS 90° L
J5	Female ORFS – Swivel – 90° Elbow – Medium Drop	ISO 12151-1 – SWEM	ORFS 90° M
J7	Female ORFS – Swivel – 45° Elbow	ISO 12151-1 – SWE 45°, SAE J516	ORFS 45°
J9	Female ORFS – Swivel – 90° Elbow – Short Drop	ISO 12151-1 – SWES, SAE J516	ORFS 90°
JC	Female ORFS – Swivel – Straight – Short	ISO 12151-1 – SWSA, SAE J516	ORFS
JD	Male ORFS – Bulkhead with Locknut – Straight (with O-ring)	ISO 12151-1 – SAE J516	
JM	ORFS Male	ISO 12151-1-S, SAE J516	
JS	ORFS Swivel Female (Long)	ISO 12151-1-SWSB, SAE J516	ORFS
L9	Female JIC 37° – Swivel – 90° Elbow – Medium Drop	ISO 12151-5-SWEM	DKJ 90° M
MU	Female Metric – Swivel – Straight (30° Flare)	JIS B8363	MU
MZ	Female Metric – Swivel – 90° Elbow (30° Flare)	JIS B8363	
NM	Male BSP Parallel Pipe – L Series – Rigid – Straight – ED-Seal	ISO 1179	
NW	Female Kärcher Metric Cleaning Hose Fitting – Swivel – Straight		
PW	Male Kärcher Metric Cleaning Hose Fitting – Rigid – Straight		
PY	Flange – 24° Male – French Gas – Straight		
S2	Female NPTF Pipe Swivel		
S5	Male Tube O-ring Swivel – Short Pilot		
T1	Male Refrigerant Tube Mender – Straight (with Nut and Ferrule)		
UT	Male BSP Taper Pipe – Rigid – Straight (60° Cone)	JIS B 8363-R	
V1	Ermeto standard Pressure Banjo – Straight (with UNF Bolt and O-ring)		
VW	Push In Connector	(VW-Standard 39-V-16619)	
VW121	BSP Swivel Female	(VW-Norm 39-V-16631)	
VW39D	Push In Connector	(VW-Standard 39D-1401)	
WKS	Rubber hand grip		
X5	Flange – Straight – Full flange system for Code 61 or Code 62		
X7	Flange – 45° Elbow – Full flange system for Code 61 or Code 62		
X9	Flange – 90° Elbow – Full flange system for Code 61 or Code 62		
XA	Caterpillar® Flange Head – Straight		
XF	Caterpillar® Flange Head – 45° Elbow		
XG	Caterpillar® Flange Head – 60° Elbow		
XN	Caterpillar® Flange Head – 90° Elbow		
XU	Female Metric – Swivel – Straight (30° Flare)	JIS B8363	
XY	Female Metric – Swivel – 90° Elbow (30° Flare)	JIS B8363	
YW	Male Standpipe – Rigid – Straight – A-Lok	Metric Size Tube O.D. with Vee Notch	

## Classification Bodies

The mission of classification bodies is to contribute to the development and implementation of technical standards for the protection of life, property and the environment.

### (1) Germanischer Lloyd (GL)

German independent organisation of technical experts approving products for the German mercantile marine and the energy sector – GLIS (oil and gas, wind energy, etc...)

### (2) Det Norske Veritas (DNV)

Norwegian service company for managing risk in ship classification, off-shore industry, etc...

### (3) RINA (Registro Italiano Navale)

Italian company offering certification, verification, control, assistance in marine, energy & process, transport and industry.

### (4) Deutsche Bahn (DB) - German Standard DIN 5510 - Part 2

The German rail authority (DB) approves the behaviour of products with respect to their resistance to burning and their ability to self-extinguish after a fire, according the DIN 5510-2 requirements.

### (5) Lloyd's Register (LR)

English independent organisation providing certification around the world. Marine services, Rail services and Energy services are their main activities.

### (6) Ministry of Defence (MOD)

British Ministry of Defence providing approvals for military equipment according the MOD DefStan (Defence Standard) 47-2 specification.

### (7) American Bureau of Shipping (ABS)

US company providing rules for safety in the marine environment.

### (8) US Department of Transportation (DOT)

US organisation providing certifications to ensure a fast, safe, efficient, accessible and convenient transportation system in this country.

### (9) US Coast Guard (USCG)

Provides maritime safety, law enforcement, recreational boating safety, and environmental protection information for merchant mariners. The approved hoses are not accepted for all applications automatically. If the column contains "H", the hose is accepted for hydraulic systems only and not for fuel and lube systems.

### (10) Mine Safety and Health Administration (MSHA)

US organisation for safety in the mining industry

### (11) French Standard NF F-16-101/102 (NF)

Tests the fire behaviour and fire effluents of the hose cover material for rail applications.

### (12) British Standard (BS 6853)

Tests the fire behaviour and fire effluents of the hose cover material for rail applications.

### (13) MarED

MarED is the Group of Notified Bodies for the Implementation of the Marine Equipment Directive.

### (14) UNI CEI 11170-1:2005

Railway and tramway vehicles  
– Guidelines for fire protection of railway, tramway and guided path vehicles

### (15) Bureau Veritas (BV)

Bureau Veritas is today the most widely recognized certification body in the world, offering solutions in the key strategic fields of operations: Quality, Health & Safety, Environment and Social Responsibility.

### (16) GIG

The Central Mining Institute (in Polish: Główny Instytut Górnictwa GIG) is a restructured scientific and development organization, subordinated to the Minister of Economy, working not only for the benefit of the mining industry, but also for enterprises representing different branches - including small and medium enterprises, state and local administration institutions and offices, and foreign partners.

### (17) Verteidigungs-Gerätenorm (VG)

German Organisation providing approvals for military equipment.

<b>EN</b>	European Standard
<b>ISO</b>	International Organisation for Standardization
<b>SAE</b>	Society of Automotive Engineers (US organisation)

Description (1)-(17) see Ab-15

# Classification Body Type Approvals

Hose	Construction	Standard	GL (1)	DNV (2)	RINA (3)	DB/DIN 5510 (4)	LR (5)	MOD (6)	ABS (7)	DOT (8)	USCG (9)	MSHA (10)	NF (11)	BS 6853 (12)	MarED (13)	UNI CEI (14)	BV Marine (15)	GIG (16)	VG (17)	Low pressure	
																				Push-Lok	Transport + Hydraulic
Multipurpose	801Plus	1 braid, fibre																			
	830M	1 braid, fibre																			
	831	1 braid, fibre																			
	837BM	1 braid, fibre																			
	837PU	1 braid, fibre																			
	804	1 braid, fibre																			
	821FR	1 braid, fibre																			
	836	1 braid, fibre											X								
	838M	1 braid, fibre																			
	601	2 braids, fibre	DIN EN 854-R3 - SAE 100R3																		
611	1 braid, fibre	DIN EN 854-R6																			
681	2 braids, fibre	DIN EN 854-2TE																			
611HT	1 braid, fibre	DIN EN 854-R6										X									
681DB	2 braids, fibre	DIN EN 854-2TE					X						X								
201	1 braid, wire	SAE 100R5 - SAE J1402AI								X											
206	1 braid, wire	SAE 100R5 - SAE J1402AI								X											
213	1 braid, wire	SAE J1402AI								X											
293	1 braid, fibre	SAE J1402AI								X											
221FR	1 braid, wire	SAE J1527TypR3	X	X					X												
285	1 braid, wire	SAE J2064TypC																			
4215N	1 braid, wire	DIN EN 853-1SN - ISO 1436-1SN/R1AT - SAE 100R1AT	X	X	X		X		X						X		X			X	X
422	1 braid, wire	DIN EN 853-1SN - ISO 1436-1SN/R1AT - SAE 100R1AT																			
3015N	2 braids, wire	DIN EN 853-2SN - SAE 100R2AT	X	X	X		X		X						X		X			X	X
302	2 braids, wire	DIN EN 853-2SN - ISO 1436-2SN/R2AT - SAE 100R2AT																			
441	1 braid, wire	ISO 11237-R16 - SAE 100R16																			
451	1/2braid, wire	ISO 11237-R17 - SAE 100R17								X											
492	1 braid, wire	Exceeds DIN EN 857-1SC - ISO 11237-1SC	X	X	X		X								X						
462	2 braids, wire	Exceeds DIN EN 857-2SC - ISO 11237-2SC	X	X	X		X								X						
301TC	2 braids, wire	Exceeds DIN EN 853-2SN - ISO 1436-2SN/R2AT																			
351TC	2 braids, wire	SAE 100 R19																			
451TC	1/2braid, wire	ISO 11237-R17 - SAE 100R17																			
471TC	2 braids, wire	DIN EN 857-2SC - ISO11237-2SC																			
472TC	2 braids, wire	DIN EN 857-2SC - ISO11237-2SC		X					X												
4925T	1 braid, wire	DIN EN 857-1SC - ISO11237-1SC																			
4625T	2 braids, wire	DIN EN 857-2SC - ISO11237-2SC																			
426	1 braid, wire	SAE 100R1AT							X												X
436	2 braids, wire	SAE 100R16							X												X
461LT	2 braids, wire	Exceeds DIN EN 857-2SC - ISO11237-2SC																			
424	1 braid, wire	SAE 100R1AT																			
304	2 braids, wire	SAE 100R2AT																			

Hose	Construction	Standard	GL (1)	DNV (2)	RINA (3)	DB/DIN 5510 (4)	LR (5)	MOD (6)	ABS (7)	DOT (8)	USCG (9)	MSHA (10)	NF (11)	BS 6853 (12)	MarED (13)	UNI CEI (14)	BV Marine (15)	GG (16)	VG (17)	Medium pressure		
																				3-braids	High pressure	
																				High pressure		
																				3-braids	Parkrimp No-Skive	ParLock
Railway	441RH	1 braid, wire	ISO 11237-R16 - SAE 100R16			X							X	X		X						
	421RH	1 braid, wire	DIN EN 853-1SN - ISO 1436-1SN/R1AT - SAE 100R1AT			X							X	X								
Water cleaning	493	1 braid, wire	-																			
	463	2 braids, wire	-																			
Pilot	402	1 braid, wire	-																			
	412	1 braid, wire	-																			
Wire cover	421WC	1 braid, wire	ISOS1436-1SN/R1AT - SAE 100R1AT																			
Powerlift	477	2 braids, wire	Excels DIN EN 853-2SN - DIN EN 856-2SC																			
	4775T	2 braids, wire	Excels DIN EN 853-2SN - DIN EN 856-2SC																			
Extremely flexible	692	1/2 braids, wire	Excels SAE 100R17																			
	692Twin	1/2 braids, wire	Excels SAE 100R17																			
Suction	811	1 braid, 1steelspiral	SAE 100R4								H	X										
	881	1 braid, 1steelspiral	SAE 100R4																			
Standard	372	3 braids, wire	-	X			X															
Low temperature	371LT	3 braids, wire	-																			
High abrasion res.	372TC	3 braids, wire	-									X										
Railway	372RH	3 braids, wire	-			X							X									
Standard	701	4 spiral, wire	DIN EN 856-4SP - ISO 3862-4SP	X																		
	731	4 spiral, wire	DIN EN 856-4SH - ISO 3862-4SH																			
	781	4/6 spiral, wire	DIN EN 856-R13 - ISO 3862-R13 - SAE 100R13																			
	P35	6 spiral, wire	DIN EN 856-R13 - ISO 3862-R13 - SAE 100R13		X				X		X	X										
Phosphate Ester	774	4 spiral, wire	-																			
	F42	4/6 spiral, wire	ISO 3862-R15 - SAE 100R15																			
Extreme pressure	761	6 spiral, wire	-																			
High abrasion resistance	721TC	4 spiral, wire	DIN EN 856-R12 - ISO 3862-R12 - SAE 100R12									X										
	782TC	4/6 spiral, wire	DIN EN 856-R13 - ISO 3862-R13 - SAE 100R13						X			X										
MSHA approved	791TC	4/6 spiral, wire	ISO 3862-R15 - SAE 100R15		X				X		X	X										
	792TC	4/6 spiral, wire	ISO 3862-R15 - SAE 100R15		X				X		H	X										
Low temperature	772LT	4 spiral, wire	DIN EN 856-R12 - ISO 3862-R12 - SAE 100R12																			
Compact spiral !	787TC	4/6 spiral, wire	SAE 100R13 - ISO 3862 Type R13 - ISO 18752-DC									X										
	797TC	4/6 spiral, wire	SAE 100R15 - ISO 3862 Type R15 - ISO 18752-DC									X										
Standard	H31	4 spiral, wire	Excels DIN EN 856-4SP - ISO 3862-4SP	X	X		X		X						X		X					
	H29	4 spiral, wire	Excels DIN EN 856-4SH - ISO 3862-4SH	X	X		X		X						X		X					
	R35	4/6 spiral, wire	DIN EN 856-R13 - ISO 3862-R13 - SAE 100R13																			
	R42	4/6 spiral, wire	ISO 3862-R15 - SAE 100R15	X			X		X						X							
High abrasion resistance	H31TC	4 spiral, wire	Excels EN 856-4SP - ISO 3862-4SP									X										
MSHA approved	H29TC	4 spiral, wire	Excels EN 856-4SH - ISO 3862-4SH									X										
	R35TC	4/6 spiral, wire	DIN EN 856-R13 - ISO 3862-R13 - SAE 100R13									X										
	R42TC	4/6 spiral, wire	ISO 3862-R15 - SAE 100R15									X										
	R50TC	4/6 spiral, wire	Excels ISO 3862 Type R15									X										
Extreme abrasion resistance	H315T	4 spiral, wire	Excels DIN EN 856-4SP - ISO 3862-4SP																			
	H295T	4 spiral, wire	Excels DIN EN 856-4SH - ISO 3862-4SH																			
	R425T	4/6 spiral, wire	ISO 3862-R15 - SAE 100R15																			
Railway	H29RH	4 spiral, wire	Excels DIN EN 856-4SH - ISO 3862-4SH			X							X									

## Conversion Chart

	Unit	Base Unit	Conversion Unit	Factor
<b>Length</b>	1 inch	in	mm	25.4
	1 millimetre	mm	in	0.03934
	1 foot	ft	m	0.3048
	1 metre	m	ft	3.28084
<b>Area</b>	1 square inch	sq in	cm <sup>2</sup>	6.4516
	1 square centimetre	cm <sup>2</sup>	sq in	0.1550
<b>Volume</b>	1 gallon (UK)	gal	l	4.54596
	1 litre	l	gal (UK)	0.219976
	1 gallon (US)	gal	l	3.78533
	1 litre	l	gal (US)	0.264177
<b>Weight</b>	1 pound	lb	kg	0.453592
	1 kilogramme	kg	lb	2.204622
<b>Torque</b>	1 pound foot	lb • ft	kg • m	1.488164
	1 Newton metre	kg • m	lb • ft	0.671969
<b>Pressure</b>	1 pound per square inch	psi	bar	0.06895
	1 bar	bar	psi	14.5035
	1 pound per square inch	psi	MPa	0.006895
	1 mega pascal	MPa	psi	145.035
	1 kilo pascal	kPa	bar	0.01
	1 bar	bar	kPa	100
	1 mega pascal	MPa	bar	10
	1 bar	bar	MPa	0.1
<b>Velocity</b>	1 foot per second	ft / s	m / s	0.3048
	1 metre per second	m / s	ft / s	3.28084
<b>Flow rate</b>	1 gallon per minute (UK)	gal / min.	l / min.	4.54596
	1 litre per minute	l / min.	gal / min. (UK)	0.219976
	1 gallon per minute (US)	gal / min.	l / min.	3.78533
	1 litre per minute	l / min.	gal / min. (US)	0.264178
<b>Temperature</b>	Fahrenheit degree	°F	°C	5/9 • (°F-32)
	Celsius degree	°C	°F	°C • (9/5) +32

(UK) Unit of United Kingdom  
 (US) Unit of USA



# Temperature / Pressure Chart

Reference 201, 206, 213 and 293 hose.

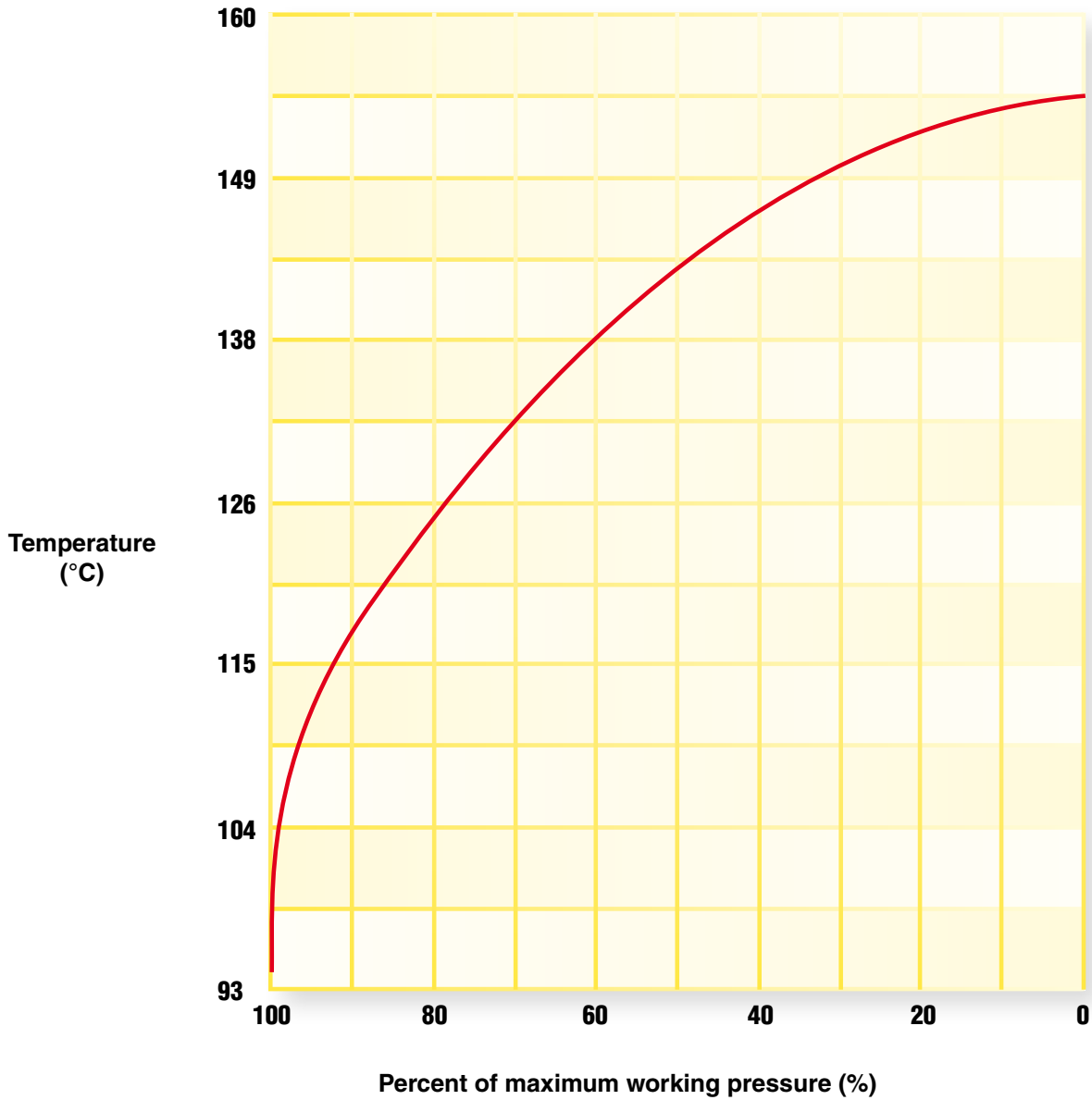

EXAMPLE: 201-8 hose to be used at 121 °C

Maximum Working Pressure up to 100 °C

Multiplication Factor x from Chart

= Maximum Working Pressure at 121 °C

13.8 MPa (2000 psi)

x 85%

= 11.7 MPa (1700 psi)

# Flow Capacity Nomogram

The chart below is provided as an aid in the determination of the correct hose size.

Example: at 10 gallons per minute (gal/min), what is the proper hose size within the recommended velocity range for pressure lines?

Locate 10 gallons per minute in the left-hand column and 20 feet per second in the right-hand column (the maximum recommended velocity range for pressure lines). Lay a straight line across these two points.

The inside diameter shown in the centre column is above -6 so we have to use -8 (1/2"). For suction hose, follow the same procedure except use recommended velocity range for intake lines in the right-hand column.

- where: Q = flow in gallons per minute (gal/min & l/min)
- V = velocity in feet per second (f/s & m/s)
- d = hose inside diameter (mm & dash size)

**Example**  
 Flow Q = 45 l/m  
 Velocity V = 6,1 m/s  
 Konstant K = 21,2025

$$D = \sqrt{\frac{Q * K}{V}} = \sqrt{\frac{45 \frac{l}{m} * 21,2025}{6,1 \frac{m}{s}}} = 12,5 \text{ mm}$$

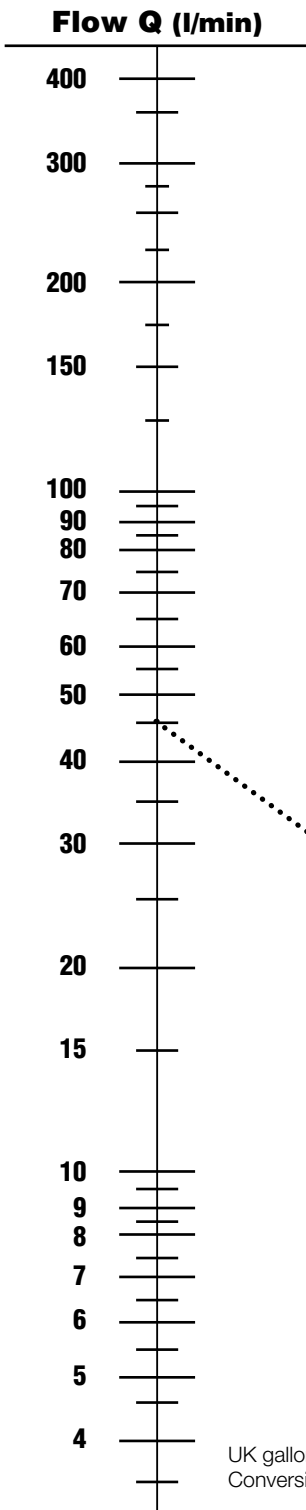

Inside diameter d	
mm	dash sizes inch
50,8	-32 2
38,1	-24 1-1/2
31,8	-20 1-1/4
25,4	-16 1
19,1	-12 3/4
15,9	-10 5/8
12,7	-8 1/2
9,5	-6 3/8
7,9	-5 5/16
6,3	-4 1/4
4,8	-3 3/16

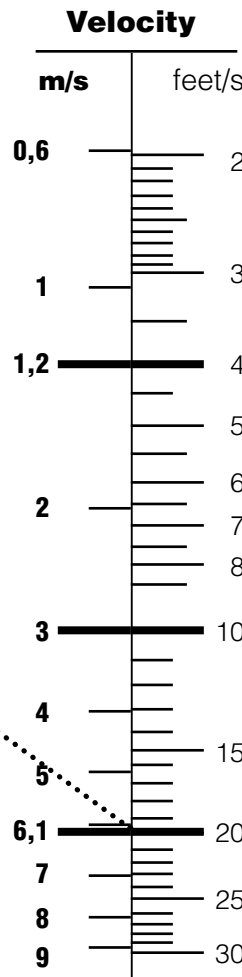

Recommended maximum velocity for suction lines

Recommended maximum velocity for return lines

Recommended maximum velocity for pressure lines

UK gallons  
 Conversion factor: gal/min x 4,546 = l/min  
 feet/s x 0,3048 = m/s

\* Recommended velocities are according to hydraulic fluids of maximum viscosity 315 S.S.U. at 38°C working at roomtemperature within 18° and 68°C.

# The Correct Method to Fit Female Swivel Ends

To ensure a leakproof seal between swivel female hose ends shown in this catalogue and the appropriate adaptors it is necessary to follow the procedure below which is different from hydraulic tube assembly.

## Flats From Wrench Resistance (FFWR)

Parker's recommended assembly method for JIC 37° flare, SAE 45° flare and ORFS swivel female is Flats From Wrench Resistance (FFWR). The torque values assigned by size are for reference only, and are only



applicable to Parker system components using the FFWR method with trivalent chromate passivation on zinc plating of carbon steel components without lubrication.

## Metal-to-metal seal



Screw the nut up hand tight and then tighten further with a spanner according to the values mentioned in the table below. Ensure that in all cases the hose is correctly aligned before tightening the nut onto the corresponding adaptor.

## Spanner torque values

### Metric swivel female

			
		nominal	min. - max.
M 12x1.5	06L	16	15 - 17
M 14x1.5	08L	16	15 - 17
M 16x1.5	10L	26	25 - 28
M 18x1.5	12L	37	35 - 39
M 22x1.5	15L	47	45 - 50
M 26x1.5	18L	89	85 - 94
M 30x2	22L	116	110 - 121
M 36x2	28L	137	130 - 143
M 45x2	35L	226	215 - 237
M 52x2	42L	347	330 - 363
M 14x1.5	06S	26	25 - 28
M 16x1.5	08S	42	40 - 44
M 18x1.5	10S	53	50 - 55
M 20x1.5	12S	63	60 - 66
M 22x1.5	14S	79	75 - 83
M 24x1.5	16S	84	80 - 88
M 30x2	20S	126	120 - 132
M 36x2	25S	179	170 - 187
M 42x2	30S	263	250 - 275
M 52x2	38S	368	350 - 385

### BSP swivel female

	size		
		nominal	min. - max.
G1/4	-4	20	15 - 25
G3/8	-6	34	27 - 41
G1/2	-8	60	42 - 76
G5/8	-10	69	44 - 94
G3/4	-12	115	95 - 135
G1	-16	140	115 - 165
G1-1/4	-20	210	140 - 280
G1-1/2	-24	290	215 - 365
G2	-32	400	300 - 500

#### Note

Values given in tables are typical to achieve the recommended assembly methods when fitting material is steel zinc plated. For other materials different values will be applicable (see our recommendations for other materials on this page).

### JIC 37° swivel female

	size	Flats From Wrench Resistance (FFWR)	Swivel Nut Torque Nm (Ref)
7/16-20	-4	2	18
1/2-20	-5	2	23
9/16-18	-6	1-1/2	30
3/4-16	-8	1-1/2	57
7/8-14	-10	1-1/2	81
1.1/16-12	-12	1-1/4	114
1.5/16-12	-16	1	160
1.5/8-12	-20	1	228
1.7/8-12	-24	1	265
2.1/2-12	-32	1	360

### ORFS swivel female

	size	Flats From Wrench Resistance (FFWR)	Swivel Nut Torque Nm (Ref)
9/16-18	-4	1/2 to 3/4	25
11/16-16	-6	1/2 to 3/4	40
13/16-16	-8	1/2 to 3/4	55
1-14	-10	1/2 to 3/4	80
1.3/16-12	-12	1/3 to 1/2	115
1.7/16-12	-16	1/3 to 1/2	150
1.11/16-12	-20	1/3 to 1/2	205
2-12	-24	1/3 to 1/2	315
2-1/2x12	-32	-	-

Note: The assembly torques listed are higher than the test torques published in SAE J1453.

The torque values for other materials are as follows:

- Brass fittings and adapters
  - 65 % of the torque value for steel.
- Stainless steel and Monel
  - Use 5% higher than listed for steel.
  - Threads to be lubricated for these materials.
- Dissimilar metals
  - Use torque value designated for the lower of the two metals.
- All fittings are dry except as noted above.

# Chemical Resistance Table

**Warning !** This chemical compatibility guide must not be used in conjunction with any other compatibility guides from previous or future catalogue editions, bulletins or publications. Incorrect use of these charts could result in death, personal injury or property damage.

## Hose Selection by Medium and Hose Type

This hose compatibility chart is a ready reference of Parker hose compatibility with various fluid media. It is intended as a guide to chemical compatibility with inner tube materials and assembly lubricants applied internally.

The outer cover of the hose is intended to protect the reinforcement layer(s) from mechanical influences (abrasion, weathering etc), as such the cover compounds are not designed to exhibit the same chemical resistance as the tube compounds. The Hose Division Technical Department should be consulted about the compatibility of the cover should the application involve the extended exposure or immersion in a liquid.

The specific recommendations are based upon field experience, the advice of various polymer or fluid suppliers, and specific laboratory experiments. It must be stressed, however, that this information is offered only as a guide. Final hose selection depends also upon pressure, fluid temperature, ambient temperature, and special requirements or variations, which may not be known by Parker. Legal and other regulations must be followed with particular care.

Where an external compatibility problem may occur, or for fluids not listed, we encourage you to first contact the fluid manufacturer for a recommendation prior to contacting your Parker Field Representative or the Technical Department, Hose Products Division Europe (HPDE\_Helpdesk@parker.com)

### Use the Chart as Follows:

1. Locate medium to be carried using the Chemical Resistance Table on the following pages.
2. Select suitability of hose and fitting material from the table based on the letter rating in the table. See resistance rating key below for explanation of compatibility ratings. See list of numerals below for an explanation when a numeral, or a numeral and a letter rating are present in the table.
3. The Column headings on the Chemical Resistance Table, I, II, III, IV, V refer to specific groups of hoses.
4. Locate hose part number under Column I, II, III, IV, V. VI from the list below.
5. For fitting material availability refer to appropriate fitting section of catalogue.
6. Check hose specifications in this catalogue. Contact Hose Products Division Europe Technical Department on any items not catalogued.

### Resistance Rating Key

A = Preferred, good to excellent with little or no change in physical properties.

F = Fair, marginal or conditional with noticeable effects on physical properties.

X = Unsuitable, severe effects on physical properties.

~ = No rating, insufficient information.

### Numerals

1. For air or gaseous applications above 250 PSI (1,7 MPa), the cover should be pin pricked.
2. Legal and insurance regulations must be considered. Contact HPDE Technical Department for more information.
3. Push-Lok hoses (801, 804, 821, 821FR, 831, 836, 837BM, 837PU, 830M, 838M) are not recommended for any type of fuel.
4. Use 285, 235 or 244 hoses. The compatibility of the system's refrigeration oil with these hoses needs to be evaluated on a case by case basis. Contact HPDE Technical Department for more information. Do not use mineral oil or alkyl benzene refrigeration oils with 244 hose. Chemical compatibility does not imply low permeation.
5. 65 °C (150 °F) maximum.
6. Satisfactory at some concentrations and temperatures, unsatisfactory at others.
7. For phosphate ester fluids use 304, 424, 774, 804 or F42 hoses.
8. Acceptable for flushing hose assemblies.
9. 221FR hose recommended.
10. For dry air applications, hoses with inner tubes from columns IV and V are preferred. See hose specifications for maximum recommended temperatures with air.
11. 100 °C (212 °F) maximum.
12. 121 °C (250 °F) maximum.
13. Hoses for gas application are available from Parker. Please contact the Technical Department for more information about the products as well as the legal application requirements.
14. 70 °C maximum for hoses 801, 837BM, 837PU
15. No rating / insufficient information about chemical compatibility for hoses 801, 837BM, 837PU.

### Hose Types

<b>Column I:</b>	201, 225, 601, 701, 721, 721TC, 731, 761, 77C, P35, 781, 791TC, 881, H31, H29, R35, R42, H31TC, H29TC, R35TC, R42TC, H31ST, H29ST, R42ST, H29RH	
<b>Column II:</b>	301TC, 351TC, 371LT, SS25UL, 421WC, 431, 441, 441RH, 451, 451TC, 451ST, 461LT, 463, 471TC, 471ST, 493, 681, 681DB, 772LT, 811	
<b>Column III:</b>	221FR, 301SN, 302, 372, 372RH, 372TC, 402, 412, 412ST, 421RH, 421SN, 422, 462, 462ST, 472TC, 477, 477ST, 492, 492ST, 692, 692Twin, 772TC, 772ST, 782TC, 782ST, 787TC, 792TC, 792ST, 797TC, 821, 831	
<b>Column IV:</b>	206, 213, 226, 266, 293, 426, 436, 611, 611HT, 821FR, 836, 801*, 837BM*, 837PU*	Note: * See Numeral 15,16
<b>Column V:</b>	304, 424, 604, 774, 804, F42 - Special EPDM hose for Phosphoric Ester	
<b>Column VI:</b>	830M, 838M	

**Caution:** The fluid manufacturer's recommended maximum operating temperature for any specific name-brand fluid should be closely observed by the user. Specific name brand fluids can vary greatly between manufacturers even though they are considered to be from the same family of fluids. Using fluids above the manufacturer's maximum recommended temperature can cause the fluid to break down, creating by-products that can be harmful to elastomers or other materials used in the system. When selecting a hose type, both the fluid manufacturer and hose manufacturer's maximum temperature limit must be taken into consideration, with the lower of the two taking precedence.

Medium	I	II	III	IV	V	VI	STEEL	BRASS	SS
3M FC-75	A	A	A	A 15	A	A	A	A	A
<b>A</b>									
Acetic Acid	X	X	X	A 15	6	X	X	X	A
Acetone	X	X	X	A 15	A	X	A	A	A
Acetylene	X	X	X	X	X	-	-	-	-
AEROSHELL Turbine Oil 500 (See MIL-L-23699)	X	X	F	X	X	-	A	A	A
Air	A, 1, 10	A, 1, 10	A, 1, 10	A, 1, 10	A, 1, 10	A	A	A	A
Air (dry)	X	F, 1, 10	F, 1, 10	A, 1, 10	A, 1, 10	A	A	A	A
Alcohol (Methanol-Ethanol)	F	F	F	A 15	F	-	F	A	A
Ammonia (Anhydrous)	X	X	X	X	X	-	X	X	X
Ammonium Chloride	A	A	A	A 15	A	A	X	X	X
Ammonium Hydroxide	F	F	F	A 15	A	X	F	X	A
Ammonium Nitrate	A	A	A	A 15	A	-	F	X	A
Ammonium Phosphate	A	A	A	A 15	A	-	X	X	F
Ammonium Sulfate	A	A	A	A 15	A	-	F	X	F
Amoco 32 Rykon	X	A	A	F 14	X	A	A	A	A
Ampol PE 46	X	X	X	X	A, 7	F	A	A	A
AMSOIL Synthetic ATF	F	A	A	A 15	X	F	A	A	A
Amyl Alcohol	X	X	X	A 15	F	-	X	A	A
Anderol 495,497,500,750	X	X	X	A 15	X	X	A	A	A
Aniline	X	X	X	A 15	A	X	A	X	A
Animal Fats	X	F	F	A 15	F	-	6	6	A
Aquacent Light, Heavy	X	A	A	X	X	A	A	A	A
Argon	A	A	A	A	A	A	A	A	A
Aromatic 100,150	X	F	F	-	X	F	A	A	A
Arrow 602P	A	A	A	A 14	X	A	A	A	A
Asphalt	X	F	F	F 14	X	A	F	F	A
ASTM #3 Oil	F	F	F	A 15	X	-	A	A	A
ATF-M	F	A	A	A 14	X	A	A	A	A
Automotive Brake Fluid	X	X	X	X	-	X	X	X	X
AW 32,46,68	F	A	A	A 14	X	A	A	A	A
<b>B</b>									
BCF	F	F	F	F 15	-	-	A	A	A
Benz Petraulic 32,46,68,100,150,220,320,460	F	A	A	A 14	X	A	A	A	A
Benzene, Benzol	X	X	X	A 15	X	F	A	A	A
Benzgrind HP 15	-	A	A	A 15	X	-	A	A	A
Benzine	X	X	X	F 15	X	-	A	A	A
Biodegradable Hydraulic Fluid 112B	X	A	A	X	-	-	A	A	A
Biodiesel E20	X	F	X	X	X	X	-	-	-
Biodiesel E100	X	F	X	X	X	X	-	-	-
Biodiesel E60	X	F	X	X	X	X	-	-	-
Biodiesel E80	X	F	X	X	X	X	-	-	-
Borax	F	F	F	A 15	A	-	F	A	A
Boric Acid	A	A	A	X	A	X	X	6	A
Brayco 882	X	A	A	A 15	X	-	A	A	A
Brayco Micronic 745	X	X	A	F 14	X	A	A	A	A
Brayco Micronic 776RP	F	A	A	F 14	X	A	A	A	A
Brayco Micronic 889	X	F	F	-	X	-	A	A	A
Brine	F	F	F	A 15	A	-	X	F	F
Butane		See 2 & 13				F	A	A	A
Butyl Alcohol, Butanol	F	F	F	A 15	F	-	F	F	A
<b>C</b>									
Calcium Chloride	A	A	A	A 15	A	-	F	F	X
Calcium Hydroxide	A	A	A	A 15	A	-	A	A	A

Medium	I	II	III	IV	V	VI	STEEL	BRASS	SS
Calcium Hypochlorite	X	X	X	A 15	A	-	X	F	X
Calibrating Fluid	A	A	A	A 14	X	A	A	A	A
Carbon Dioxide, gas	F	F	F	F 15	6	-	A	A	A
Carbon Disulfide	X	X	X	A 15	X	-	A	F	A
Carbon Monoxide (hot)	F	F	F	A 15	6	-	F	6	A
Carbon Tetrachloride	X	X	X	A 15	X	-	6	6	6
Carbonic Acid	F	F	F	X	F	X	X	X	F
Castor Oil	A	A	A	A 15	A	-	A	A	A
Castrol 5000	X	F	F	A 15	X	X	A	A	A
Cellosolve Acetate	X	X	X	X	A	-	X	X	A
Celluguard	A	A	A	-	A	-	A	A	A
Cellulube 90, 150, 220 300, 550, 1000	X	X	X	-	A	-	A	A	A
Chevron Clarity AW 32, 46, 68	A	A	A	A 14	X	A	A	A	A
Chevron FLO-COOL 180	F	F	F	-	X	-	A	A	A
Chevron FR-8, 10, 13, 20	X	X	X	X	A, 7	F	A	A	A
Chevron Hydraulic Oils AW MV 15, 32, 46, 68, 100	A	A	A	A 14	X	A	A	A	A
Chevron HyJet IV (9)	X	X	X	X	A, 7	F	A	A	A
Citric Acid	F	A	A	X	A	X	X	X	6
Commonwealth EDM 242, 244	A	A	A	-	X	A	A	A	A
CompAir CN300	X	X	X	A 15	X	X	A	A	A
CompAir CS100, 200, 300, 400	X	X	X	A 15	X	X	A	A	A
Coolanol 15, 20, 25, 35, 45	A	A	A	A 15	A	X	A	A	A
Copper Chloride	F	A	A	X	A	-	X	X	X
Copper Sulfate	A	A	A	X	A	-	X	X	F
Cosmolubric HF-122, HF-130, HF-144	X	F	A	X	X	-	A	A	A
Cosmolubric HF-1530	X	F	A	X	X	-	A	A	A
Cottonseed Oil	F	A	A	F 15	X	-	A	A	A
CPI CP-4000	X	X	X	A 15	X	-	A	A	A
Crude Petroleum Oil	F	A	A	A 14	X	A	F	F	A
CSS 1001 Dairy Hydraulic Fluid	F	A	A	A 15	X	-	A	A	A
<b>D</b>									
Daphne AW32	A	A	A	A 14	X	A	A	A	A
Dasco FR 201-A	A	A	A	-	X	-	A	A	A
Dasco FR150, 200, 310	F	A	A	-	A	-	A	A	A
Dasco FR300, FR2550	X	X	X	-	X	F	A	A	A
Dasco FR355-3	X	F	A	X	X	X	A	A	A
Deicer Fluid 419R	A	A	A	-	-	A	A	A	A
Deionized Water	A	A	A	A 15	A	-	F	F	A
Dexron II ATF	F	A	A	A 14	X	A	A	A	A
Dexron III ATF	X	F, 11	F, 11	A 15, 12	X	-	A	A	A
Diesel Fuel	F, 3	A, 3	A, 3	A 15, 3	X	A(2)	A	A	A
Diester Fluids	X	X	X	A 15	X	X	A	A	A
Dow Corning 2-1802 Sullair (24KT)	-	-	-	F 15	-	-	A	A	A
Dow Corning DC 200, 510, 550, 560, FC126	A	A	A	A 15	-	-	A	A	A
Dow HD50-4	F	F	F	-	-	-	-	-	A
Dow Sullube 32	-	-	-	F 15	-	-	A	A	A
Dowtherm A,E	X	X	X	A 15	X	-	A	A	A
Dowtherm G	X	X	X	X	X	-	A	A	A
Duro AW-16, 31	A	A	A	-	X	-	A	A	A
Duro FR-HD	A	A	A	-	X	-	A	A	A
<b>E</b>									
EcoSafe FR-68	A	A	A	-	X	X	A	A	A
Ethanol	F	F	F	A 15	F	-	F	A	A
Ethers	X	X	X	A 15	X	-	A	A	A

Medium	I	II	III	IV	V	VI	STEEL	BRASS	SS
Ethyl Acetate	X	X	X	A 15	F	-	F	A	A
Ethyl Alcohol	F	F	F	A 15	F	-	F	A	A
Ethyl Cellulose	F	F	F	A 15	F	-	X	F	F
Ethyl Chloride	X	X	X	X	A	-	F	F	F
Ethylene Dichloride	X	X	X	A 15	X	-	X	A	X
Ethylene Glycol	F	A	A	A	A	A	A	F	A
Exxon 3110 FR	A	A	A	A 15	X	A	A	A	A
Exxon Esstic	A	A	A	A 14	A	A	A	A	A
Exxon Nuto H 46, 68	A	A	A	A 14	X	A	A	A	A
Exxon Tellura Industrial Process Oils	A	A	A	A 14	X	A	A	A	A
Exxon Terresstic, EP	A	A	A	A 14	A	A	A	A	A
Exxon Turbo Oil 2380	X	F	F	A 15	X	X	A	A	A
Exxon Univolt 60, N61	F	A	A	A 14	X	A	A	A	A
<b>F</b>									
FE 232 (Halon)	X	X	X	X	F	-	A	A	A
Fenso 150	-	A	A	-	X	A	A	A	A
Formaldehyde	X	X	X	A 15	A	-	X	F	A
Formic Acid	X	X	X	X	A	X	X	6	X
Freons see refrigerants	-	-	-	-	-	-	-	-	-
Fuel Oil	F, 3	A, 3	A, 3	A 15, 3	X	A(2)	A	A	A
Fyre-Safe 120C, 126, 155, 1090E, 1150, 1220, 1300E	X	X	X	X	A, 7	F	A	A	A
Fyre-Safe 200C, 225, 211	F	A	A	A	A	F	A	A	A
Fyre-Safe W/O	A	A	A	A 15	X	A	A	A	A
Fyrguard 150, 150-M, 200	A	A	A	A	A	F	A	A	A
Fyrquel 60, 90, 150, 220, 300, 550, 1000	X	X	X	X	A, 7	F	A	A	A
Fyrquel EHC, GT, LT, VPF	X	X	X	X	A, 7	F	A	A	A
Fyrtek MF, 215, 290, 295	X	X	X	X	X	F	A	A	A
<b>G</b>									
Gardner-Denver GD5000, GD8000	X	X	X	A 15	X	X	A	A	A
Gasoline		See 9				-	A	A	A
Glue	F	F	F	-	X	-	A	F	A
Glycerine, Glycerol	A	A	A	A 15	A	-	A	F	A
Grease	A	A	A	A 14	X	A	A	A	A
Gulf-FR Fluid P37, P40, P43, P45, P47	X	X	X	A 15	A	-	A	A	A
<b>H</b>									
H-515 (NATO)	A	A	A	-	X	-	A	A	A
Halon 1211, 1301	F	F	F	F 15	-	-	A	A	A
Helium Gas	X	X	X	X	X	-	A	A	A
Heptane	X	F	F	A 15	X	-	A	A	A
Hexane	X	F	F	A 15	X	-	A	A	A
HF-20, HF-28		A	A	A	A	F	A	A	A
Houghto-Safe 1055, 1110, 1115, 1120, 1130 (9)	X	X	X	X	A, 7	F	A	A	A
Houghto-Safe 271 to 640	F	A	A	A	A	F	A	A	A
Houghto-Safe 419 Hydraulic Fluid	A	A	A	-	X	-	A	A	A
Houghto-Safe 419R Deicer Fluid	A	A	A	-	-	A	A	A	A
Houghto-Safe 5046, 5046W, 5047-F	A	A	A	A 15	X	-	A	A	A
HP 100C (Jack hammer oil)	F	A	A	A 14	X	A	A	A	A
HPWG 46B	F	A	A	A	-	F	A	A	A
Hul-E-Mul	A	A	A	-	X	-	A	A	A
Hychem C, EP1000, RDF	A	A	A	A 15	A	-	A	A	A
Hydra Safe E-190	A	A	A	A 15	X	-	A	A	A
Hydra-Cut 481, 496	A	A	A	-	X	-	A	A	A
Hydrafluid 760	A	A	A	-	X	-	A	A	A
Hydrochloric Acid	X	X	X	X	X	X	X	X	X

Medium	I	II	III	IV	V	VI	STEEL	BRASS	SS
Hydrofluoric Acid	X	X	X	X	X	X	X	6	X
Hydrogen Gas	X	X	X	X	X	-	A	A	A
Hydrogen Peroxide	X	X	X	A 15	X	-	X	X	6
Hydrogen Sulfide	X	X	X	X	A	-	X	X	6
Hydrolube	A	A	A	A 15	A	-	A	A	A
Hydrolubric 120-B, 141, 595	F	A	A	A 15	A	-	A	A	A
Hydrosafe Glycol 200	A	A	A	A	A	F	A	F	A
HyJet IV	X	X	X	X	A, 7	-	A	A	A
<b>I</b>									
Ideal Yellow 77	A	A	A	A 15	X	-	A	A	A
Imol S150 to S550	X	X	X	-	-	-	A	A	A
Ingersoll Rand SSR Coolant	X	X	X	A 15	X	X	A	A	A
Isocyanates	X	X	X	A 15	X	-	A	-	A
Isooctane	X	F	F	A 15	X	-	A	A	A
Isopar H	X	X	X	X	X	-	A	A	A
Isopropyl Alcohol	F	F	F	A 15	F	-	F	A	A
<b>J</b>									
Jayflex DIDP	X	X	X	X	A	-	A	A	A
JP3 and JP4	X	A,3	A,3	-	X	A(2)	A	A	A
JP5	X	A,3	A,3	F 15,3	X	A(2)	A	A	A
JP9	X	X	X	X	X	-	A	-	A
<b>K</b>									
Kaeser 150P, 175P, 325R, 687R	X	X	X	A 15	X	-	A	A	A
Kerosene	X	A	A	F 14	X	A	A	A	A
KSL-214, 219, 220, 222	X	X	X	A 15	X	-	A	A	A
<b>L</b>									
Lacquer	X	X	X	A 15	X	-	X	A	A
Lacquer Solvents	X	X	X	A 15	X	-	X	A	A
Lactic Acids	X	X	X	X	X	X	X	X	A
Lindol HF	X	X	X	A 15	A	-	A	A	A
Linseed Oil	A	A	A	A 15	A	-	A	A	A
LP-Gas		See 13				-	A	A	A
<b>M</b>									
Magnesium Chloride	A	A	A	A 15	A	-	X	X	X
Magnesium Hydroxide	F	F	F	A 15	A	-	F	F	F
Magnesium Sulfate	A	A	A	A 15	A	-	A	F	A
Mercaptans	X	X	X	X	X	-	-	-	-
Methane		See 13				-	A	A	A
Methanol	F	F	F	A 15	F	-	F	A	A
Methyl Alcohol	F	F	F	A 15	F	-	F	A	A
Methyl Chloride	X	X	X	A 15	X	-	A	A	A
Methyl Ethyl Ketone (MEK)	X	X	X	A 15	X	-	F	A	A
Methyl Isopropyl-Ketone	X	X	X	X	X	-	F	A	A
Metsafe FR303, FR310, FR315, FR330, FR350	X	X	X	X	X	F	A	A	A
Microzol-T46	X	A	A	-	X	-	A	A	A
MIL-B-46176A	X	X	X	X	X	-	X	X	X
MIL-H-46170	X	F	F	A 15	X	-	A	A	A
MIL-H-5606	F	A	A	A 14	X	A	A	A	A
MIL-H-6083	F	A	A	A 15	X	-	A	A	A
MIL-H-7083	F	A	A	A 15	X	-	A	A	A
MIL-H-83282	F	A	A	A 15	X	-	A	A	A
MIL-L-2104, 2104B	F	A	A	A 14	X	A	A	A	A
MIL-L-23699	X	X	X	X	X	X	A	A	A
MIL-L-7808	F	A	A	-	X	-	A	A	A



Medium	I	II	III	IV	V	VI	STEEL	BRASS	SS
Mine Guard FR	A	A	A	-	A	-	A	A	A
Mineral Oil	A	A	A	F 14	X	A	A	A	A
Mineral Spirits	8	8	8	8	X	-	A	A	A
Mobil Aero HFE	F	A	A	F 14	X	A	A	A	A
Mobil DTE 11M, 13M, 15M, 16M, 18M, 19M	F	A	A	A 14	X	A	A	A	A
Mobil DTE 22, 24, 25, 26	F	A	A	A 14	X	A	A	A	A
Mobil EAL 224H	X	A	A	X	-	-	A	A	A
Mobil EAL Artic 10, 15, 22,32, 46, 68, 100	X	X	X	X	X	X	A	A	A
Mobil Glygoyle 11, 22, 30, 80	A	A	A	-	X	-	A	A	A
Mobil HFA	F	A	A	A 15	X	-	A	A	A
Mobil Jet 2	X	F	F	A 15	X	-	A	A	A
Mobil Nyvac 20, 30, 200, FR	F	A	A	A	A	F	A	A	A
Mobil Rarus 824, 826, 827	X	X	X	A 15	X	X	A	A	A
Mobil SHC 600 Series	F	A	A	A 15	X	-	A	A	A
Mobil SHC 800 Series	F	A	A	A 15	X	-	A	A	A
Mobil SHL 624	-	A	A	A 15	X	-	A	A	A
Mobil Vactra Oil	A	A	A	F 14	X	A	A	A	A
Mobil XRL 1618B	X	X	X	X	A, 7	F	A	A	A
Mobilfluid 423	F	A	A	A 14	X	A	A	A	A
Mobilgear SHC 150, 220, 320, 460, 680	F	F	F	A 15	X	-	A	A	A
Mobilrama 525	A	A	A	F 14	X	A	A	A	A
Molub-Alloy 890	X	X	X	A 15	X	-	A	A	A
Moly Lube "HF" 902	F	F	F	F 14	X	A	A	A	A
Monolec 6120 Hydraulic Oil	A	A	A	A 14	X	A	A	A	A
Morpholine (pure additive)	X	X	X	X	X	-	X	X	A
<b>N</b>									
Naptha	X	F	F	A 15	X	-	A	A	A
Napthalene	X	X	X	A 15	X	-	A	A	A
Natural Gas		See 13				-	A	A	A
Nitric Acid	X	X	X	X	X	X	X	X	F
Nitrobenzene	X	X	X	A 15	X	-	X	X	A
Nitrogen, gas	F, 1	F, 1	F, 1	F 15, 1	F, 1	-	A	A	A
NORPAR 12, 13, 15	8	8	8	8	X	-	A	A	A
Nuto H 46, 68	A	A	A	A 14	X	A	A	A	A
Nyvac 20, 30, 200, FR	F	A	A	A	A	F	A	A	A
Nyvac Light	X	X	X	-	A	-	A	A	A
<b>O</b>									
Oceanic HW	F	A	A	A	X	F	A	A	A
Oxygen, gas	X	X	X	X	X	-	X	A	A
Ozone	F	F	F	-	A	-	A	A	A
<b>P</b>									
Pacer SLC 150, 300, 500, 700	X	X	X	A 15	X	-	A	A	A
Pennzbell AWX	F	A	A	F 14	X	A	A	A	A
PENTOSIN CHF 11S	F	A	A	F	A	X	A	A	A
Perchloroethylene	X	X	X	X	X	-	F	X	A
Petroleum Ether	X	F	F	F 14	X	A	A	A	A
Petroleum Oils	A	A	A	A 14	X	A	A	A	A
Phenol (Carbolic Acid)	X	X	X	A 15	X	X	X	F	A
Phosphate Ester Blends	X	X	X	X	X	F	A	A	A
Phosphate Esters	X	X	X	X	A, 7	-	A	A	A
Phosphoric Acid	X	X	X	X	X	X	X	X	F
Plurasafe P 1000, 1200	F	A	A	A	F	F	A	A	A
Polyalkylene Glycol	A	F	F	-	X	-	A	A	A
Polyol Ester	X	F	A	X	X	-	A	A	A

Medium	I	II	III	IV	V	VI	STEEL	BRASS	SS
Potassium Chloride	A	A	A	A 15	A	-	X	F	F
Potassium Hydroxide	X	X	X	A 15	A	-	6	X	A
Potassium Sulfate	A	A	A	A 15	A	-	A	A	A
Propane		See 13				-	A	A	A
Propylene Glycol	F	A	A	A 15	A	-	F	F	F
Pydraul 10-E, 29-E, 50-E, 65-E, 90-E, 115-E	X	X	X	X	A, 7	F	A	A	A
Pydraul 230-C, 312-C, 68-S	X	X	X	X	A, 7	F	A	A	A
Pydraul 60, 150, 625, F9	X	X	X	X	A, 7	-	A	A	A
Pydraul 90, 135, 230, 312, 540, MC	X	X	X	X	X	-	A	A	A
Pydraul A-200	X	X	X	A 15	X	-	A	A	A
Pyro Gard 43, 230, 630	X	X	X	X	X	-	A	A	A
Pyro Gard C, D, R, 40S, 40W	F	A	A	F 15	X	A	A	A	A
Pyro Guard 53, 55, 51, 42	X	X	X	X	A, 7	-	A	A	A
<b>Q</b>									
Quintolubric 700	A	A	A	A 15	A	-	A	F	A
Quintolubric 807-SN	F	A	A	-	X	-	A	A	A
Quintolubric 822, 833	X	F, 5	A, 5	X	X	X	A	A	A
Quintolubric 822-68EHC (71°C, 160°F maximum)	X	F, 5	A, 5	-	-	-	A	A	A
Quintolubric 888	X	F, 5	A, 5	X	X	-	A	A	A
Quintolubric 957, 958	F	A	A	A	A	F	A	A	A
Quintolubric N822-300	~	~	A	-	-	-	A	A	A
Quintolubric N888	X	A	F	X	-	X	A	A	A
<b>R</b>									
Rando	A	A	A	A 14	X	A	A	A	A
Rayco 782	X	F	A	X	X	-	X	X	X
Refrigerant 124		See 4				X	A	A	A
Refrigerant Freon 113, 114	X	X	X	X	X	X	A	A	A
Refrigerant Freon 12		See 4		X		X	A	A	A
Refrigerant Freon 22		See 4		X		X	A	A	A
Refrigerant Freon 502		See 4		X		X	A	A	A
Refrigerant HFC134A		See 4		X		X	A	A	A
Reolube Turbofluid 46	X	X	X	X	A, 7	-	A	A	A
Rotella	A	A	A	A 14	X	A	A	A	A
Royal Bio Guard 3032, 3046, 3068, 3100	X	~	A	X	X	X	A	A	A
Royco 2200, 2210, 2222, 2232, 2246, 2268	X	X	X	X	X	X	A	A	A
Royco 4032, 4068, 4100, 4150	X	X	X	A 15	X	X	A	A	A
Royco 756, 783	A	A	A	A 14	X	A	A	A	A
Royco 770	X	F	F	F 15	X	-	A	A	A
RTV Silicone Adhesive Sealants	X	X	X	X	X	-	A	A	A
<b>S</b>									
Safco-Safe T10, T20	-	-	-	-	A	-	F	F	A
Safety-Kleen ISO 32, 46, 68 hydraulic oil	F	A	A	-	X	A	A	A	A
Safety-Kleen Solvent	8	8	8	8	X	-	A	A	A
Santoflex 13	F	F	F	-	F	-	A	A	A
Santosafe 300	X	X	X	-	X	-	A	A	A
Santosafe W/G 15 to 30	-	-	-	A 15	A	-	A	A	A
Sea Water	F	F	F	A 15	A	-	X	F	A
Sewage	F	F	F	A 15	F	-	X	F	A
Shell 140 Solvent	8	8	8	8	X	-	A	A	A
Shell Clavus HFC 68	X	X	X	X	X	X	A	A	A
Shell Comptella Oil	F	F	F	A 14	X	A	A	A	A
Shell Comptella Oil S 46, 68	F	F	F	A 14	X	A	A	A	A
Shell Comptella Oil SM	F	F	F	A 14	X	A	A	A	A
Shell Diala A, (R) Oil AX	F	A	A	F 14	X	A	A	A	A

Medium	I	II	III	IV	V	VI	STEEL	BRASS	SS
Shell FRM	-	-	-	-	X	-	A	A	A
Shell IRUS 902, 905	A	A	A	-	A	-	A	A	A
Shell Naturelle HF-E	F	A	A	F	A	X	A	A	A
Shell Pella-A	A	A	A	A 15	X	-	A	A	A
Shell Tellus	F	A	A	A 14	X	A	A	A	A
Shell Tellus TD 46	A	A	A	A	A	X	A	A	A
Shell Thermia Oil C	A	A	A	A 14	X	A	A	A	A
Shell Turbo R	X	F	F	A 15	X	X	A	A	A
SHF 220, 300, 450	X	X	A	X	X	X	A	A	A
Silicate Esters	A	F	F	A 15	X	-	A	A	A
Silicone Oils	A	A	A	-	-	-	A	A	A
Silicone Sealants	X	X	X	X	X	-	A	A	A
Skydrol 500B-4, LD-4	X	X	X	X	A, 7	F	A	A	A
Soap Solutions	X	F	F	F 15	A	-	A	A	A
Soda Ash, Sodium Carbonate	A	A	A	A 15	A	-	A	F	A
Sodium Bisulfate	F	F	F	A 15	A	-	F	A	F
Sodium Chloride	F	F	F	A 15	A	-	X	F	A
Sodium Hydroxide	X	X	X	A 15	A	-	A	X	A
Sodium Hypochlorite	F	F	F	X	F	-	X	X	X
Sodium Nitrate	F	F	F	A 15	A	-	A	F	A
Sodium Peroxide	X	X	X	X	A	-	X	X	A
Sodium Silicate	A	A	A	A 15	A	-	A	A	A
Sodium Sulfate	A	A	A	A 15	A	-	A	A	A
Soybean Oil	F	A	A	A 15	A	-	A	A	A
SSR Coolant	X	X	X	A 15	X	X	A	A	A
Steam	X	X	X	X	X	-	F	A	A
Stoddard Solvent	8	8	8	8	X	-	A	A	A
Sulfur Chloride	X	X	X	A 15	X	-	X	X	X
Sulfur Dioxide	X	X	X	X	F	-	X	F	F
Sulfur Trioxide	X	X	X	A 15	F	-	X	X	X
Sulfuric Acid (0% to 30% room temperture)	F, 6	F, 6	F, 6	X	F, 6	-	6	X	6
Summa-20, Rotor, Recip	X	X	X	A 15	X	-	A	A	A
Summit DSL-32,68,100,125	X	X	X	A 15	X	-	A	A	A
Sun Minesafe, Sun Safe	X	F	F	A 15	X	-	A	A	A
Sundex 8125	X	F	F	-	A	-	A	A	A
Suniso 3GS	A	A	A	A 14	X	A	A	A	A
Sun-Vis 722	X	F	F	-	X	-	A	A	A
Super Hydraulic Oil 100, 150, 220	A	A	A	A 14	X	A	A	A	A
SUVA MP 39, 52, 66	X	X	X	X	X	X	A	A	A
SYNCON Oil	X	X	X	X	X	-	A	A	A
Syndale 2820	X	F	F	-	-	-	A	A	A
Synesstic 32,68,100	X	X	X	X	X	X	A	A	A
Syn-Flo 70,90	X	X	X	A 15	X	-	A	A	A
SYN-O-AD 8478	X	X	X	X	A, 7	F	A	A	A
<b>T</b>									
Tannic Acid	F	A	A	A 15	A	X	X	F	X
Tar	F	F	F	A 15	X	-	X	F	A
Tellus (Shell)	F	A	A	A 14	X	A	A	A	A
Texaco 760 Hydrafluid	-	-	-	-	X	-	A	A	A
Texaco 766, 763 (200 - 300)	-	-	-	-	A	-	F	F	A
Texaco A-Z Oil	A	A	A	F 14	X	A	A	A	A
Texaco Spindura Oil 22	F	F	F	F 14	X	A	A	A	A
Texaco Way Lubricant 68	A	A	A	A 14	X	A	A	A	A
Thanol-R-650-X	X	F	F	-	X	-	A	A	A

Medium	I	II	III	IV	V	VI	STEEL	BRASS	SS
Thermanol 60	X	X	X	X	X	-	A	A	A
Toluene, Toluol	X	X	X	X	X	-	A	A	A
Transmission Oil	A	A	A	A 14	X	A	A	A	A
Tribol 1440	X	F	F	X	X	F	A	A	A
Trichloroethylene	X	X	X	A 15	X	-	X	A	A
Trim-Sol	F	A	A	A 15	X	-	A	A	A
Turbinol 50, 1122, 1223	X	X	X	X	A, 7	-	A	A	A
Turpentine	X	X	X	A 15	X	-	A	A	A
<b>U</b>									
Ucon Hydrolubes	F	A	A	A	A	F	A	A	A
UltraChem 215,230,501,751	X	X	X	A 15	X	-	A	A	A
Univis J26	A	A	A	A 14	X	A	A	A	A
Unleaded Gasoline		See 9				-	A	A	A
Unocal 66/3 Mineral Spirits	8	8	8	8	X	-	A	A	A
Urea	F	F	F	A 15	F	-	F	-	F
Urethane Formulations	A	A	A	A 15	-	-	A	A	A
<b>V</b>									
Van Straaten 902	A	A	A	A 15	X	-	A	A	A
Varnish	X	X	X	A 15	X	-	F	F	A
Varsol	8	F	F	8	X	-	A	A	A
Versilube F44, F55		A	A	A 15	-	-	A	A	A
Vinegar	X	X	X	A 15	A	-	F	X	A
Vital 29, 4300, 5230, 5310	X	X	X	X	X	-	A	A	A
Volt Esso 35	A	A	A	A 15	X	-	A	A	A
<b>W</b>									
Water	F	A	A	A	A	A	F	A	A
Water / Glycols	A	A	A	A	A	F	A	F	A
<b>X</b>									
Xylene, Xylol	X	X	X	X	X	-	A	A	A
<b>Z</b>									
Zerol 150	A	A	A	A 14	X	A	A	A	A
Zinc Chloride	A	A	A	X	A	-	X	X	F
Zinc Sulfate	A	A	A	X	A	-	X	A	A

# Identifying Fitting Types

In general fittings can be identified by their visual appearance, their sealing surface/sealing type or by their thread type/form. Viewing the following pages, the visual identification will be self explanatory. The sealing mechanism and the method of thread identification, however, needs further explanation

## Determining Sealing Mechanisms:

- Thread interface
- O-ring
- Matching angle or metal-to-metal joint
- Mated angle with O-ring

### Thread Interface

The sealing is assured by the flattening of the edges of the threads when the male is screwed into the female fitting. Typically the front of the male fittings is narrower than the back of the fittings – often referred to as tapered threads.

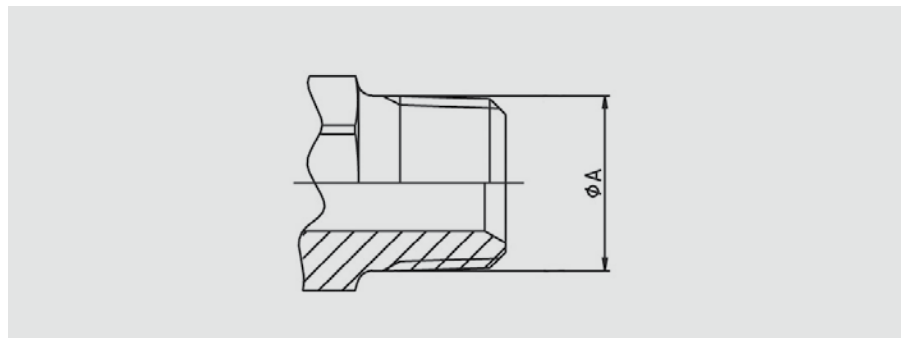

### O-ring

The O-ring on the male is compressed against the corresponding female and assures the seal. This type of sealing mechanism should be the preferred choice for high-pressure applications.

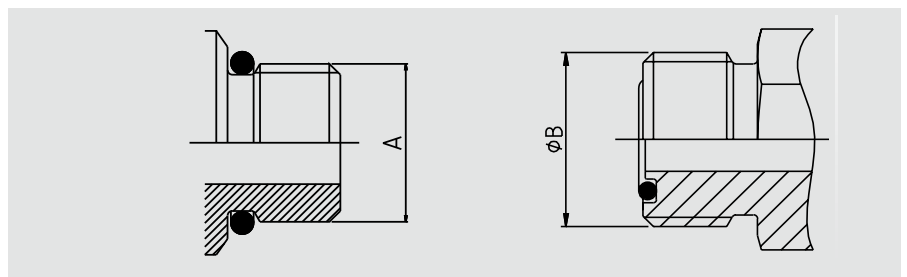

### Matching Angle or Metal-to-Metal Joint

Sealing takes place where the two angled faces of the male and corresponding female meet and are wedged into one another by the tightening of the threaded nut. The sealing surfaces can either be convex or concave (seat) on the male or in the head of the pipe of the female as shown.

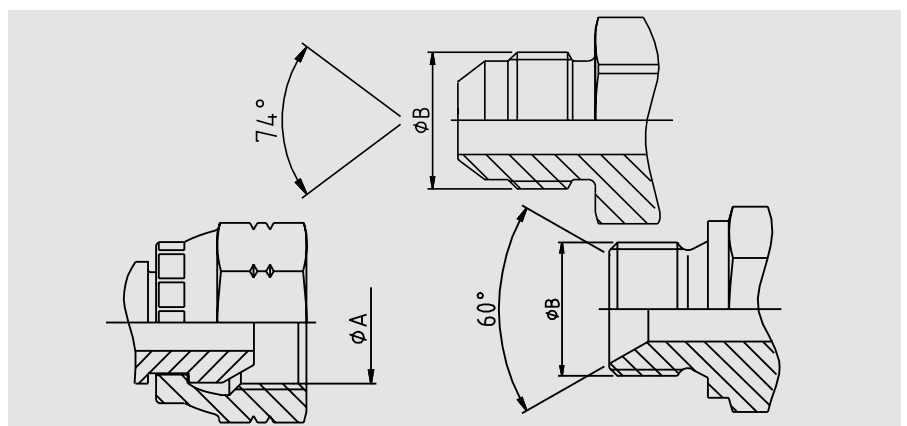

**Matching Angle with O-ring**

These fittings combine the functionality of both the matching angle seal with the O-ring. The O-ring is in the angled sealing surface of the fitting so that when the threaded male and female are screwed together the sealing surfaces wedge together and at the same time deform the O-ring between them.

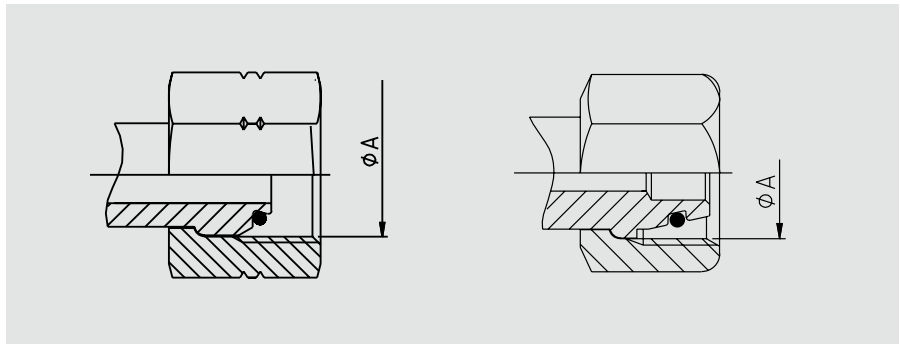

# Determining the Thread Type

In general of the threads of various fittings look similar and hinder the easy identification of the thread. To assure the correct identification, the threads must be measured and compared to the tables listed in the following section.

**Thread Gauge**

Using a thread gauge, the number of threads per inch can be determined. Holding the gauge and coupling threads in front of a lighted background helps to obtain an accurate measurement.

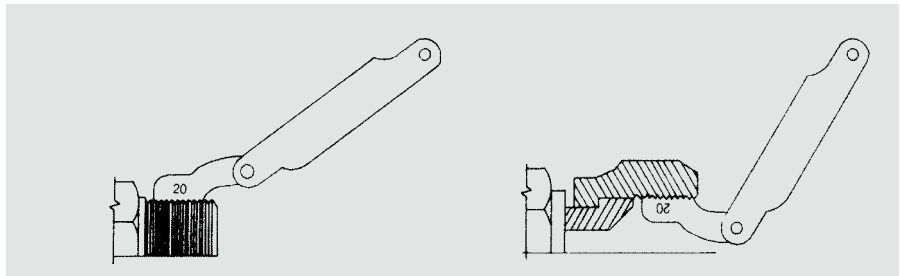

**Caliper Measure**

A vernier caliper should be used to measure the thread diameter of the largest point. (Outside diameter (O.D.) of male threads – Inside Diameter (I.D.) of female threads.)

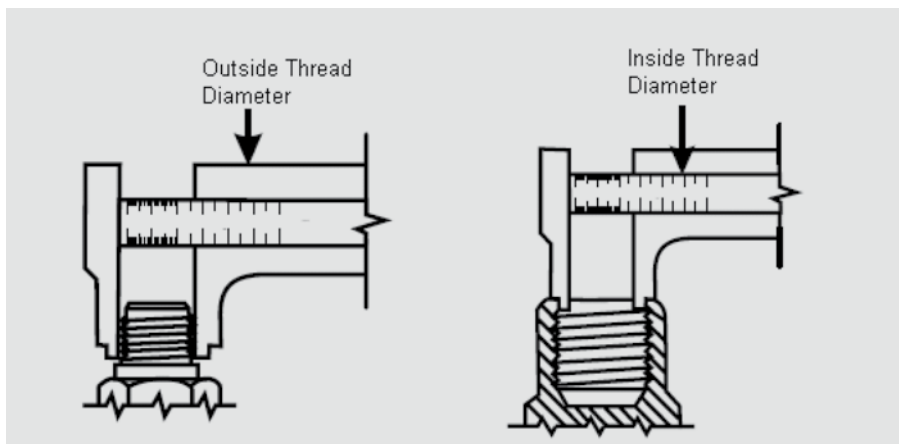

# German DIN Hose Fittings

(DIN – Deutsches Institut für Normung)

Often referred to as metric fittings, these fittings seal using the angled sealing surfaces (metal-to-metal) or the combination of metal-to-metal with O-rings.

They are available in **very light (LL)**, **light (L)** or **heavy series (S)**.

The sealing face angles are either 24° with or without O-rings, or 24°/60° universal cones.

Identification is made by measuring the thread size and also the tube outside diameter.

Defined by the outside diameter and the pitch (distance between 2 crests of the thread) example: M22x1.5 - pitch of 1.5mm.

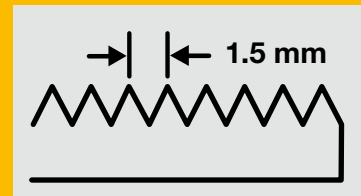

## DIN Very Light Series (LL)

The male 60° cone will mate with the female 60° cone only.

The male has a 60° sealing angle (seat) and straight metric thread.

The female has a 60° seat and straight metric thread.

Standard

**DIN 20078 Part 3** <sup>1)</sup>

Parker end configurations

**C0**

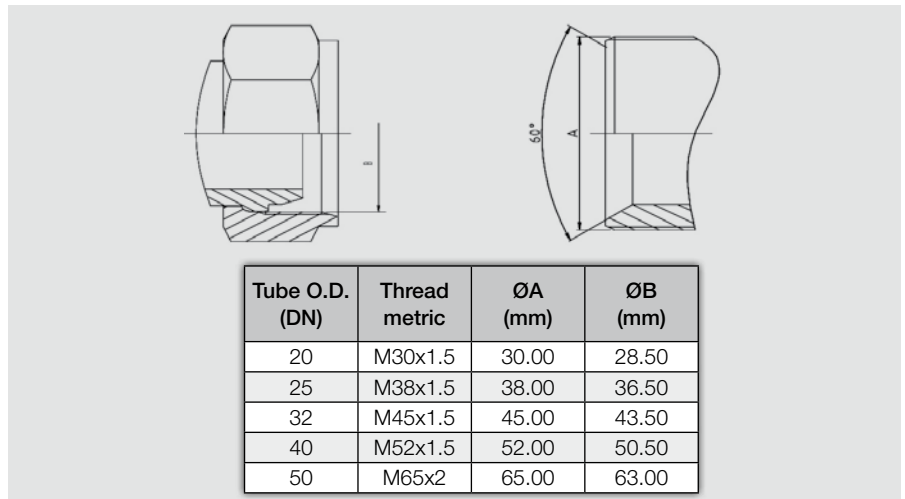

## DIN Light (L) and Heavy Series (S) without O-ring

The male 60° cone will mate with the female universal 24° or 60° cone only.

The male has a 60° sealing angle (seat) and straight metric threads.

The female has a 24° and 60° universal seat and straight metric threads.

Standard

**DIN 20078 Part 2** <sup>1)</sup>

(previously known as DIN 20078 A, D & E)

Parker end configurations

light series

**C3, C4, C5, C6**

(Often also referred to as “Ball nose cones”)

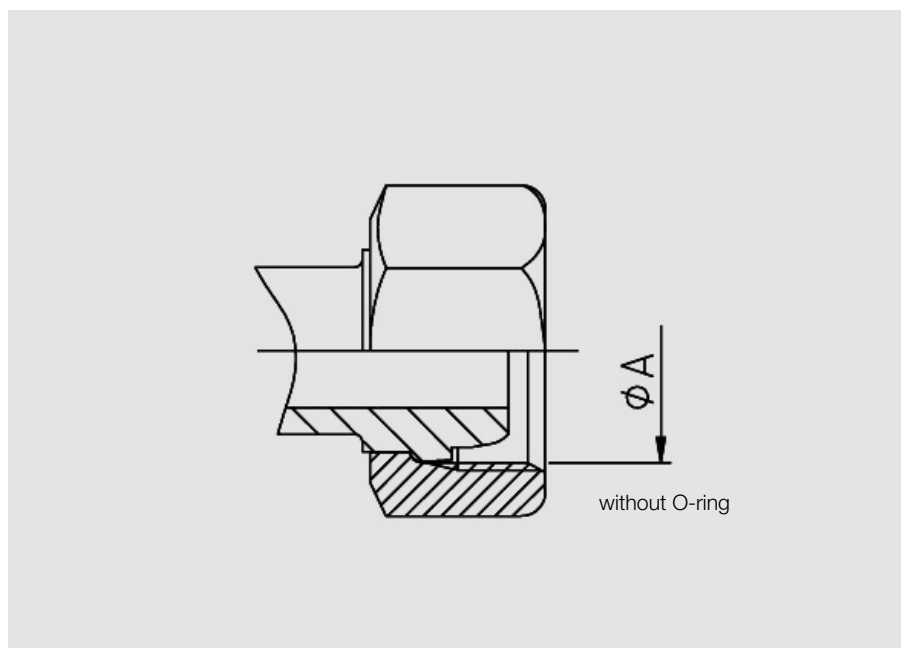

<sup>1)</sup> obsolete standard, no exact replacement

**DIN 24° Light (L) and Heavy Series (S) with O-ring**

The male has a 24° sealing angle cone seat with straight metric threads.

The female has a 24° convex cone with O-ring and a swivel straight metric threaded nut.

Standard

**ISO 12151-2 / ISO 8434-1 & ISO 8434-4**

(Previously

DIN 20 078 Part 4, 5, 8, 9)

Parker end configurations  
light series

**CA, CE, CF, D0**

Parker end configurations  
heavy series

**C9, 0C, 1C, D2**

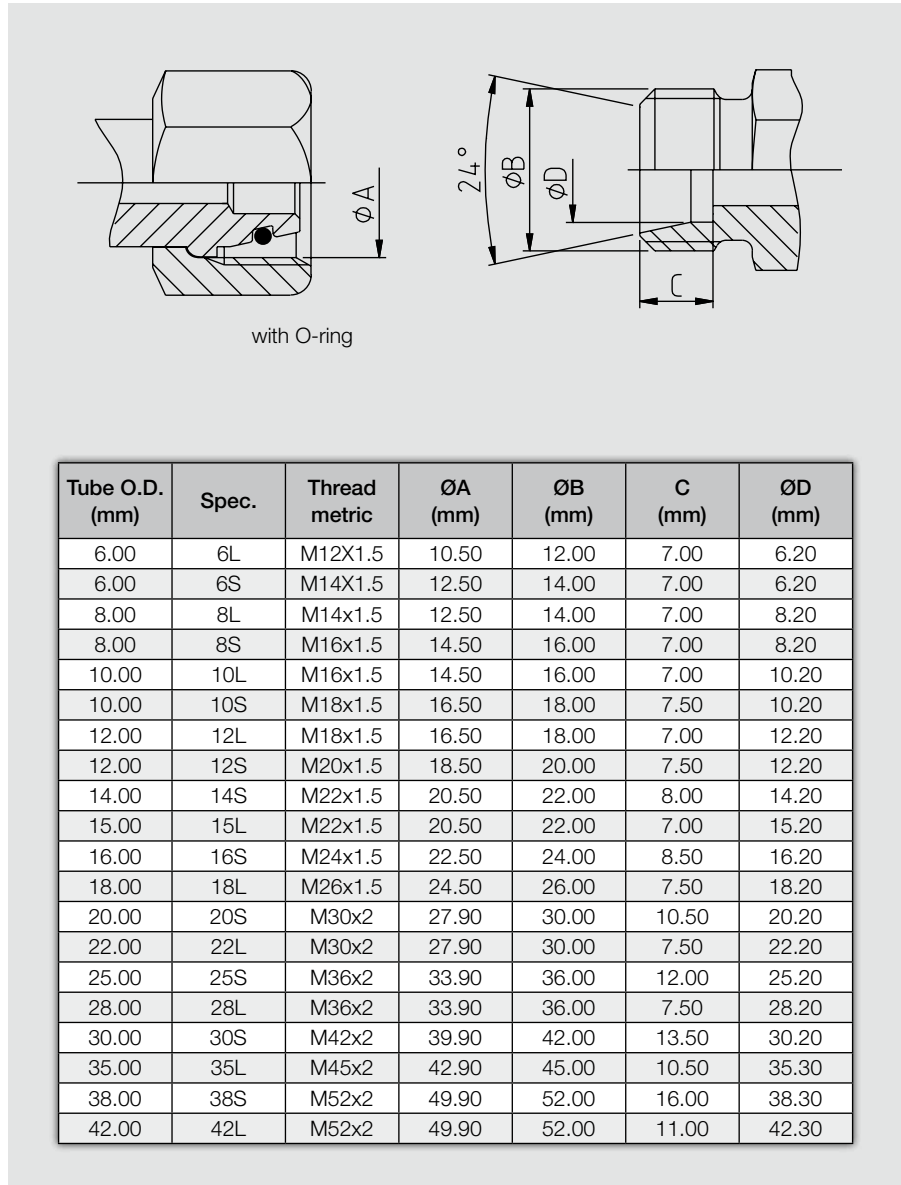



# British Standard Pipe (BSP)

Also referred to as Whitworth threads, the BSP thread type fittings seal use metal-to-metal angled surfaces or a combination of metal-to-metal and an O-ring.

The angle of the sealing surfaces is 60° for both forms.

There are two popular thread forms:

British Standard Pipe Parallel (BSPP) and

British Standard Pipe Tapered (BSPT).

Identification is made by measuring the outside diameter of the thread and the number of threads per inch (25.4 mm)

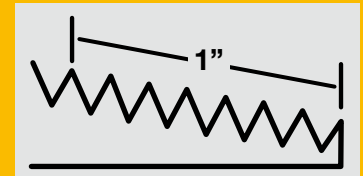

## BSPP

metal-to-metal without O-ring  
Standard

### BS5200

Parker end configurations

**92, B1, B2, B4, D9**

## BSPP

metal-to-metal with O-ring  
Standard

### ISO 12151-6

Parker end configurations

**EA, EB, EC, EE, D9**

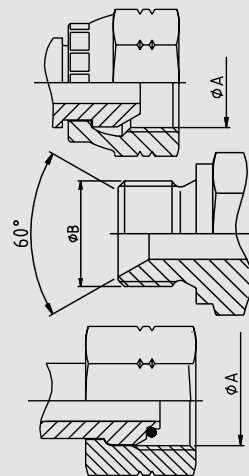

Tube I.D./O.D. (mm)	Size	Thread BSP	ØA (mm)	ØB (mm)
6/10	-2	1/8x28	8.60	9.70
8/13	-4	1/4x19	11.50	13.20
12/17	-6	3/8x19	14.90	16.70
15/21	-8	1/2x14	18.60	20.90
18/23	-10	5/8x14	20.60	22.90
20/27	-12	3/4x14	24.10	26.40
26/34	-16	1x11	30.30	33.20
33/42	-20	1-1/4x11	38.90	41.90
40/49	-24	1-1/2x11	44.90	47.80
50/60	-32	2x11	56.70	59.60

## BSPT

fittings seal through the thread interface mechanism. Care should be taken not to confuse the BSPT fitting with the NPTF male fitting. BSPT has a 55° thread angle. NPTF has 60° thread angle.

Parker end configuration

**91**

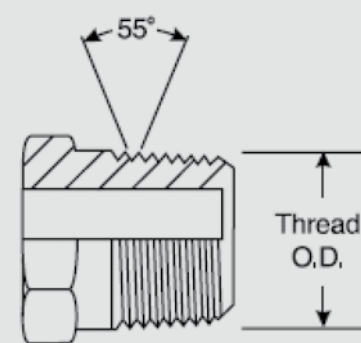

Tube I.D./O.D. (mm)	Size	Thread BSP	ØA (mm)
5/10	-2	1/8x28	9.73
8/13	-4	1/4x19	13.16
12/17	-6	3/8x19	16.66
15/21	-8	1/2x14	20.96
20/27	-12	3/4x14	26.44
26/34	-16	1x11	33.25
33/42	-20	1-1/4x11	41.91
40/49	-24	1-1/2x11	47.80
50/60	-32	2x11	59.61

## BSP Flat Seal

These fittings have BSP parallel threads but the sealing surface is flat. The seal is made when the composite seal is compressed against the female flat face.

Parker end configurations

**B5, B6, B7**

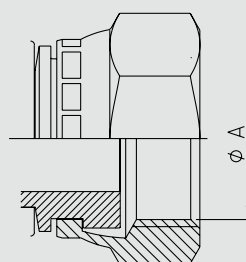

Tube I.D./O.D. (mm)	Size	Thread BSP	ØA (mm)
6/10	-2	1/8x28	8.6
8/13	-4	1/4x19	11.5
12/17	-6	3/8x19	14.9
15/21	-8	1/2x14	18.6
18/23	-10	5/8x14	20.6
20/27	-12	3/4x14	24.1
26/34	-16	1x11	30.3

# French Gas fittings

Typical to the French market the French Gas fittings have a 24° sealing surfaces seat with metric straight threads. Although similar to German DIN fittings the threads differ in some sizes as the French Gas fittings have fine threads in all sizes whereas the German DIN fittings use standard threads in the larger sizes.

## French Metric 24° Cone Gas Fittings

The sealing mechanism is metal-to-metal.

The fittings are not specified in any international standard.

Parker end configurations

**F6, F9** (metric tube)

**FG, F2, F4** (gas tube)

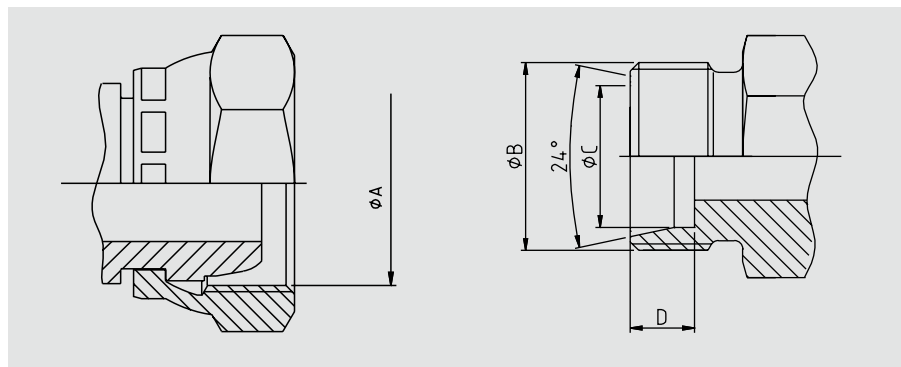

Tube O.D. (mm)	Spec.	Thread metric	ØA (mm)	ØB (mm)	ØC (mm)	D (mm)
6.00	6N	M12x1	11.00	12.00	6.20	9.00
8.00	8N	M14x1.5	12.50	14.00	8.15	9.00
10.00	10N	M16x1.5	14.50	16.00	10.20	9.00
12.00	12N	M18x1.5	16.50	18.00	12.15	9.00
13.25	13G	M20x1.5	18.50	20.00	13.50	9.00
14.00	14N	M20x1.5	18.50	20.00	14.15	9.00
15.00	15N	M22x1.5	20.50	22.00	15.15	9.00
16.00	16N	M24x1.5	22.50	24.00	16.15	9.00
16.75	17G	M24x1.5	22.50	24.00	17.00	9.00
18.00	18N	M27x1.5	25.50	27.00	18.15	9.00
20.00	20N	M27x1.5	25.50	27.00	20.15	9.00
21.25	21G	M30x1.5	28.50	30.00	21.50	9.00
22.00	22N	M30x1.5	28.50	30.00	22.15	9.00
25.00	25N	M33x1.5	31.50	33.00	25.15	9.00
26.75	27G	M36x1.5	34.50	36.00	27.00	9.00
28.00	28N	M36x1.5	34.50	36.00	28.25	9.00
30.00	30N	M39x1.5	37.50	39.00	30.25	9.00
32.00	32N	M42x1.5	40.50	42.00	32.25	9.00
33.25	34G	M45x1.5	43.50	45.00	33.80	9.00
35.00	35N	M45x1.5	43.50	45.00	35.25	9.00
38.00	38N	M48x1.5	46.50	48.00	38.25	9.00
40.00	40N	M52x1.5	50.50	52.00	40.35	9.00
42.25	42G	M52x1.5	50.50	52.00	42.55	9.00
48.25	49G	M58x2	55.90	58.00	49.00	11.00

# North American Thread Types

This type of fitting uses the thread interface to seal and as such has a tapered thread that deforms and forms the seal.

They have 30° sealing angle surfaces, forming a 60° inverted (concave) seat.

The fittings are most frequently seen on machines of US origin.

## Dryseal American Standard Taper Pipe Thread (NPTF)

The NPTF male will mate with the NPTF, NPSF, or NPSM females.

Care should be taken not to confuse the NPTF fitting with the BSPT male fitting. NPTF fittings have a 60° thread angle.

BSPT has a 55° thread angle.

Standard

### SAE J516

Parker end configuration

**01**

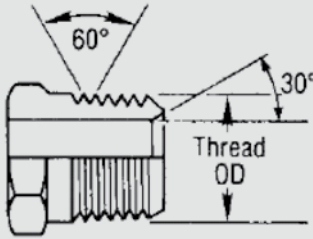

Size	Thread NPTF	ØA (mm)	ØB (mm)
-2	1/8x27	10.24	8.73
-4	1/4x18	13.61	11.90
-6	3/8x18	17.05	15.90
-8	1/2x14	21.22	19.05
-12	3/4x14	26.56	24.60
-16	1x11.5	33.22	30.95
-20	1-1/4x11.5	41.98	39.69
-24	1-1/2x11.5	48.05	45.24
-32	2x11.5	60.09	57.15

ØA dimension is measured on the 4th pitch of the thread

## SAE JIC 37°

Commonly referred to as JIC fittings, these metal-to-metal sealing type fittings have a 37° flare (sealing surface angle) and straight United National Fine Threads (UNF).

The original design specification for the fittings comes from the Society of Automotive Engineers (SAE) and these fittings are the most common American fitting types in Europe.

Standard

### ISO 12151-5, ISO8434-2 and SAE J516

Parker JIC hose fittings are fully compatible with Parker Triple-Lok Tube Fittings and adapters.

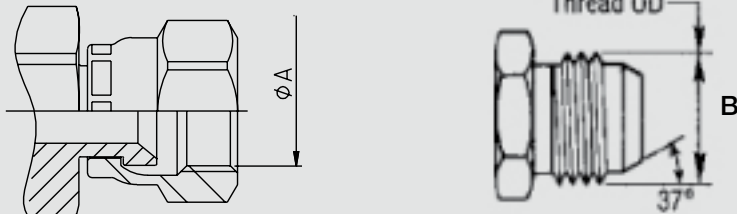

Tube O.D. (inch)	Tube O.D. (mm)	Thread UNF	Size	ØA (mm)	ØB (mm)
3/16		3/8x24	-3	8.60	9.50
1/4	6	7/16x20	-4	10.00	11.10
5/16	8	1/2x20	-5	11.60	12.70
3/8	10	9/16x18	-6	13.00	14.30
1/2	12	3/4x16	-8	17.60	19.10
5/8	14-15-16	7/8x14	-10	20.50	22.20
3/4	18-20	1-1/16x12	-12	24.60	27.00
7/8	22	1-3/16x12	-14	28.30	30.10
1	25	1-5/16x12	-16	31.30	33.30
1-1/4	30-32	1-5/8x12	-20	39.20	41.30
1-1/2	38	1-7/8x12	-24	45.60	47.60
2		2-1/2x12	x32	61.50	63.50

Parker end configurations

**03, 06/68, 37/3V, 39/3W, 41/3Y, L9**

**SAE 45° Flare**

The angle of the flare is commonly used as a name when referring to these metal-to-metal sealing fittings.

The female fittings have a 90° concave inverted seat, created by the 45° angle sealing surfaces.

The SAE 45° flare male will mate with an SAE 45° flare female only or a dual seat JIC 37°/SAE45°.

Standard

**SAE J516**

Parker end configurations

**04, 08/68, 77/3V, 79/3W, 81/3Y**

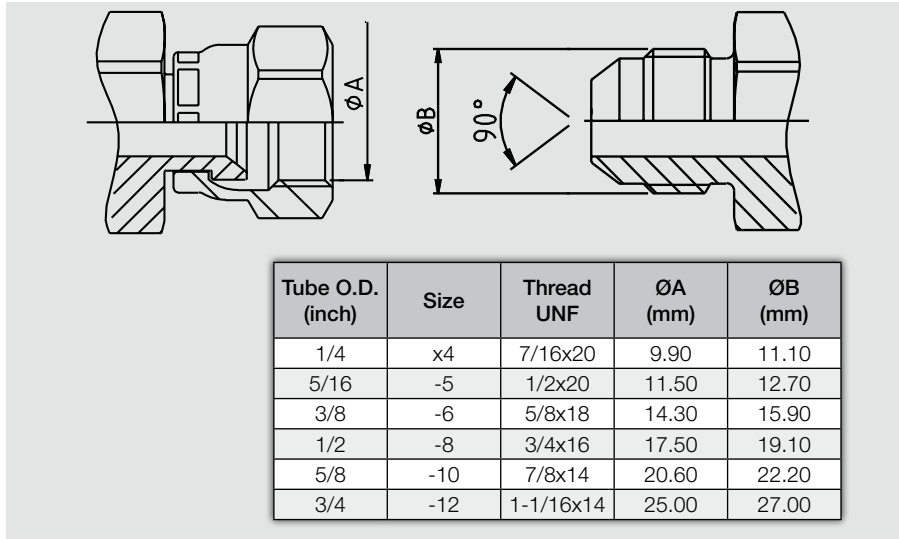

**SAE O-ring (Boss Type)**

This male fitting has straight threads, a sealing face and an O-ring. It is compatible only with female boss type fittings generally found in the ports of machines. Sealing is achieved through the O-ring of the male and through the sealing face of the female.

Parker end configuration

**05**

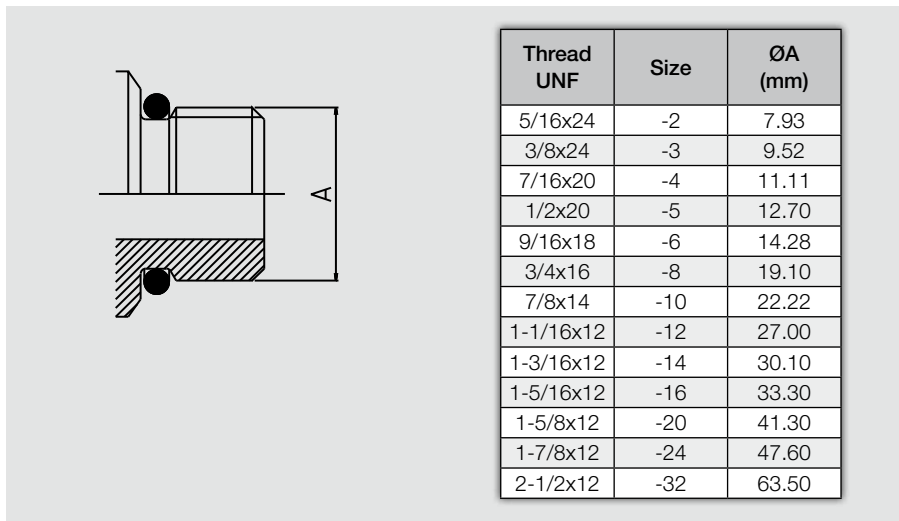

**O-ring Face Seal (ORFS)**

ORFS fittings are becoming the most popular international fitting type used on global OEM machines due to their high level of sealing and their good vibration resistance. The fittings use the O-ring compression mechanism to seal.

The female fittings have flat faces and straight threaded UNF swivel nuts. The male fittings have the O-ring in a groove in the flat face. Seen as a major advantage, these fittings offer the possibility to build the hose assemblies into fixed distances/spaces, without having to move back other system components due the flat faces of the male and female fittings – the hose assembly can be slotted in.

Standard

**ISO 12151-1, ISO8434-3 and SAE J516**

Parker end configurations

**JC, JM/J0, JS, JU, J1, J3, J5, J7, J9**

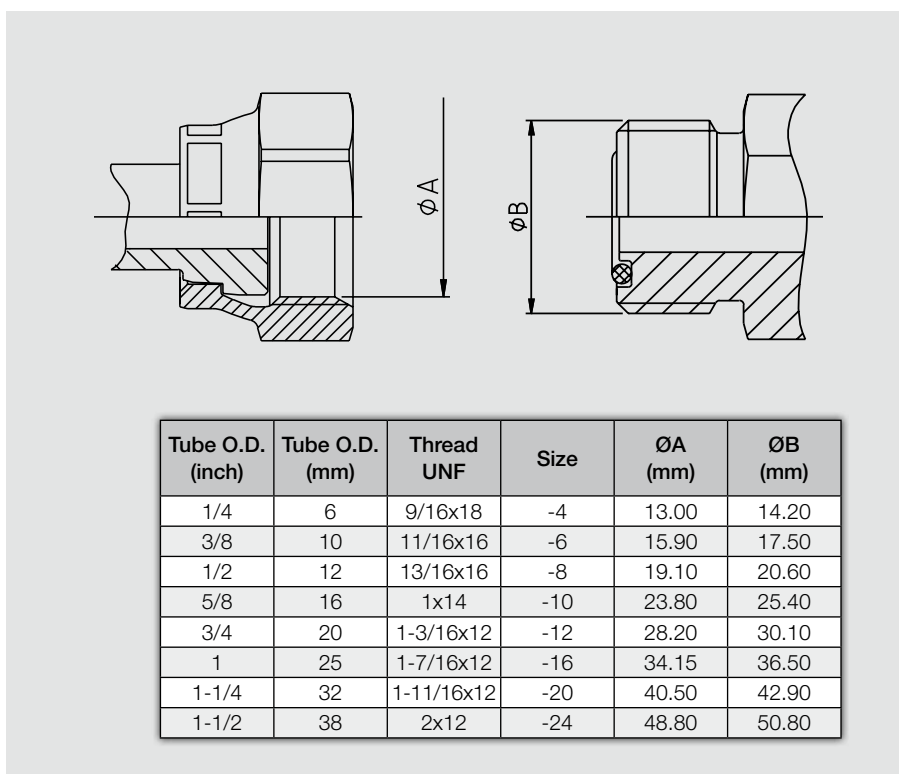

**Flange Fittings  
Code 61 and Code 62**

The 4-bolt split flange (or full flange) fitting is used worldwide for connecting high-pressure hoses typically to pumps, motors and cylinders, where the hose assemblies are subjected to large pressure loadings. The sealing mechanism is through compression of the O-ring in the face of the flange head against the surface of the port/connection.

The flange fittings are generally separated into two pressure classes referred to as 3000 psi (SFL) or 6000 psi (SFS). ISO 12151-3 refers to the flange fittings as code 61 for the 3000 psi and code 62 for the 6000 psi. In addition to these flanges, customer-specific Komatsu® and CATERPILLAR® flanges can also be found in the market.

Parker end configurations  
Code 61 (3000 psi)

**15, 16, 17, 19, P5, P7, P9**

5000 psi (Code 61 dimensions)

**4A, 4F, 4N**

Code 62 (6000 psi)

**6A, 6F, 6N, PA, PF, PN, 89**

Caterpillar flange

**XA, XF, XG, XN**

Although not in the SAE or the ISO standard the size -10 (5/8) flange head is gaining popularity. This flange is often found on Komatsu equipment or hydrostatic drives in agricultural machines.

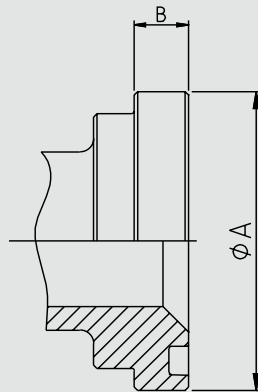

- Standard Code 61 for 3000 to 5000 psi max., depending on size
- High Pressure Code 62 for 6000 psi max. regardless of size

Flange (inch)	Size	Code 61 MPa / psi	Code 62 MPa / psi
1/2	-8	34.5 / 5000	41.3 / 6000
3/4	-12	34.5 / 5000	41.3 / 6000
1	-16	34.5 / 5000	41.3 / 6000
1-1/4	-20	27.5 / 4000	41.3 / 6000
1-1/2	-24	20.7 / 3000	41.3 / 6000
2	-32	20.7 / 3000	41.3 / 6000

Note: 5000 psi in size -20/-24/-32 with 4A,4F and 4N fittings and 50H flange halves.

**Code 61 – SAE – 3000 psi**

Flange (inch)	Size	ØA (mm)	B (mm)	O-Ring
1/2	-8	30.18	6.73	18.64x3.53
3/4	-12	38.10	6.73	24.99x3.53
1	-16	44.45	8.00	32.92x3.53
1-1/4	-20	50.80	8.00	37.69x3.53
1-1/2	-24	60.33	8.00	47.22x3.53
2	-32	71.42	9.53	56.74x3.53
2-1/2	-40	84.12	9.53	69.44x3.53
3	-48	101.60	9.53	85.32x3.53

**Code 62 – SAE – 6000 psi**

Flange (inch)	Size	ØA (mm)	B (mm)	O-Ring
1/2	-8	31.75	7.75	18.64x3.53
3/4	-12	41.28	8.76	24.99x3.53
1	-16	47.63	9.53	32.92x3.53
1-1/4	-20	53.98	10.29	37.69x3.53
1-1/2	-24	63.50	12.57	47.22x3.53
2	-32	79.38	12.57	56.74x3.53

**CATERPILLAR®**

Flange (inch)	Size	ØA (mm)	B (mm)	O-Ring
3/4	-12	41.28	14.22	25.40x5.00
1	-16	47.63	14.22	31.90x5.00
1-1/4	-20	53.98	14.22	38.20x5.00
1-1/2	-24	63.50	14.22	44.70x5.00

**Komatsu®**

Flange (inch)	Size	ØA (mm)	B (mm)	O-Ring
5/8	-10	34.25	6.00	21.7x3.5

**4-Bolt Split Flange**

A 4-bolt split flange is used to attach the flange fittings to their ports.

- Standard Code 61 for 3000 to 5000 psi max., depending on size
- High Pressure Code 62 for 6000 psi max., regardless of size

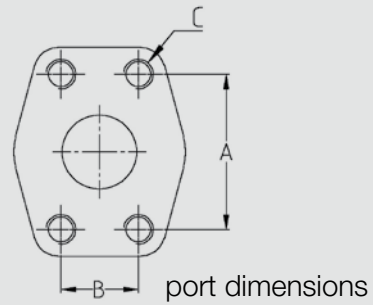

**Code 61 – SAE – 3000 psi**

Flange (inch)	Size	A (mm)	B (mm)	C	
				(inch)	(metr.)
1/2	-8	38.1	17.5	5/16x18	M8x1.25
3/4	-12	47.6	22.3	3/8x16	M10x1.5
1	-16	52.4	26.2	3/8x16	M10x1.5
1-1/4	-20	58.7	30.2	7/16x14	M10x1.5
1-1/2	-24	69.9	35.7	1/2x13	M12x1.75
2	-32	77.8	42.8	1/2x13	M12x1.75*

**Code 62 – SAE – 6000 psi**

Flange (inch)	Size	A (mm)	B (mm)	C	
				(inch)	(metr.)
1/2	-8	40.5	18.2	5/16x18	M8x1.25
3/4	-12	50.8	23.8	3/8x16	M10x1.5
1	-16	57.2	27.8	7/16x14	M12x1.75
1-1/4	-20	66.7	31.8	1/2x13	M12x1.75*
1-1/2	-24	79.4	36.5	5/8x11	M16x2
2	-32	96.8	44.4	3/4x10	M20x2.5

\*M14x2 still used in the market but no longer in accordance with ISO 6162

# Japanese fittings

The Japanese Industrial Standard (JIS) is seen on most Japanese equipment and uses a 30° sealing angle seat and either British Standard Pipe Parallel or metric threads.

Care must be taken not to confuse the JIS fittings with BSP or JIC fittings.

## Japanese fittings - JIS

The sealing mechanism of the fittings is the 30° metal-to-metal angled surfaces

Parker end configurations

**MU, XU (Metric)**

**FU (BSP)**

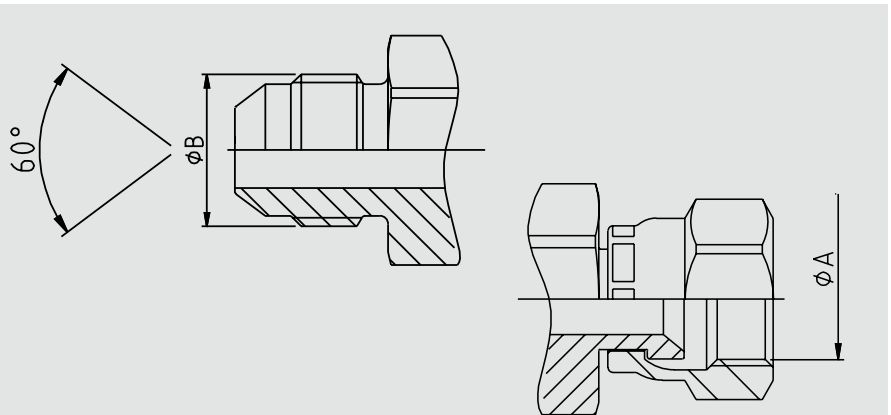

### JIS 30° metric

Symbol	Thread metric	ØA (mm)	ØB (mm)
MU-6	M14x1.5	12.50	14.00
MU-9	M18x1.5	16.50	18.00
MU-12	M22x1.5	20.50	22.00
MU-15	M27x2	25.00	27.00
MU-19	M27x2	25.00	27.00
MU-25	M33x2	31.00	33.00
MU-32	M42x2	40.00	42.00
MU-38	M50x2	48.00	50.00
MU-50	M60x2	58.00	60.00

### JIS 30° BSP

Symbol	Thread BSP	ØA (mm)	ØB (mm)
GUI-3	1/8x28	8.60	9.70
GUI-5/-6	1/4x19	11.50	13.20
GUI-8/-9	3/8x19	14.90	16.70
GUI-12	1/2x14	18.60	20.90
GUI-15/-19	3/4x14	24.10	26.40
GUI-25	1x11	30.30	33.20
GUI-32	1-1/4x11	38.90	41.90
GUI-38	1-1/2x11	44.90	47.80
GUI-50	2x11	56.70	59.60

## Parker Safety Guide for Selecting and Using Hose, Tubing, Fittings and Related Accessories

Parker Publication No. 4400-B.1

Revised: November, 2007



### WARNING

Failure or improper selection or improper use of hose, tubing, fittings, assemblies or related accessories ("Products") can cause death, personal injury and property damage. Possible consequences of failure or improper selection or improper use of these Products include but are not limited to:

- Fittings thrown off at high speed.
- High velocity fluid discharge.
- Explosion or burning of the conveyed fluid.
- Electrocution from high voltage electric powerlines.
- Contact with suddenly moving or falling objects that are controlled by the conveyed fluid.
- Injections by high-pressure fluid discharge.
- Dangerously whipping Hose.
- Contact with conveyed fluids that may be hot, cold, toxic or otherwise injurious.
- Sparking or explosion caused by static electricity buildup or other sources of electricity.
- Sparking or explosion while spraying paint or flammable liquids.
- Injuries resulting from inhalation, ingestion or exposure to fluids.

Before selecting or using any of these Products, it is important that you read and follow the instructions below. Only Hose from Parker's Stratoflex Products Division is approved for in flight aerospace applications.

### 1.0 GENERAL INSTRUCTIONS

1.1 Scope: This safety guide provides instructions for selecting and using (including assembling, installing, and maintaining) these Products. For convenience, all rubber and/or thermoplastic products commonly called "hose" or "tubing" are called "Hose" in this safety guide. All assemblies made with Hose are called "Hose Assemblies". All products commonly called "fittings", "couplings" or "adapters" are called "Fittings". All related accessories (including crimping and swaging machines and tooling) are called "Related Accessories". This safety guide is a supplement to and is to be used with the specific Parker publications for the specific Hose, Fittings and Related Accessories that are being considered for use. Parker publications are available at [www.parker.com](http://www.parker.com). SAE J1273 ([www.sae.org](http://www.sae.org)) and ISO 17165 2 ([www.ansi.org](http://www.ansi.org)) also provide recommended practices for hydraulic Hose Assemblies.

1.2 Fail-Safe: Hose, Hose Assemblies and Fittings can and do fail without warning for many reasons. Design all systems and equipment in a fail safe mode, so that failure of the Hose, Hose Assembly or Fitting will not endanger persons or property.

1.3 Distribution: Provide a copy of this safety guide to each person responsible for selecting or using Hose and Fitting products. Do not select or use Parker Hose or Fittings without thoroughly reading and understanding this safety guide as well as the specific Parker publications for the Products.

1.4 User Responsibility: Due to the wide variety of operating conditions and applications for Hose and Fittings, Parker does not represent or warrant that any particular Hose or Fitting is suitable for any specific end use system. This safety guide does not analyze all technical parameters that must be considered in selecting a product. The user, through its own analysis and testing, is solely responsible for:

- Making the final selection of the Products.
- Assuring that the user's requirements are met and that the application presents no health or safety hazards.
- Providing all appropriate health and safety warnings on the equipment on which the Products are used.
- Assuring compliance with all applicable government and industry standards.

1.5 Additional Questions: Call the appropriate Parker technical service department if you have any questions or require any

additional information. See the Parker publication for the Products being considered or used, or call 1 800 CPARKER, or go to [www.parker.com](http://www.parker.com), for telephone numbers of the appropriate technical service department.

### 2.0 HOSE AND FITTING SELECTION INSTRUCTIONS

2.1 Electrical Conductivity: Certain applications require that the Hose be nonconductive to prevent electrical current flow. Other applications require the Hose and the Fittings and the Hose/Fitting interface to be sufficiently conductive to drain off static electricity. Extreme care must be exercised when selecting Hose and Fittings for these or any other applications in which electrical conductivity or nonconductivity is a factor. The electrical conductivity or nonconductivity of Hose and Fittings is dependent upon many factors and may be susceptible to change. These factors include but are not limited to the various materials used to make the Hose and the Fittings, Fitting finish (some Fitting finishes are electrically conductive while others are nonconductive), manufacturing methods (including moisture control), how the Fittings contact the Hose, age and amount of deterioration or damage or other changes, moisture content of the Hose at any particular time, and other factors. The following are considerations for electrically nonconductive and conductive Hose. For other applications consult the individual catalog pages and the appropriate industry or regulatory standards for proper selection.

2.1.1 Electrically Nonconductive Hose: Certain applications require that the Hose be nonconductive to prevent electrical current flow or to maintain electrical isolation. For applications that require Hose to be electrically nonconductive, including but not limited to applications near high voltage electric lines, only special nonconductive Hose can be used. The manufacturer of the equipment in which the nonconductive Hose is to be used must be consulted to be certain that the Hose and Fittings that are selected are proper for the application. Do not use any Parker Hose or Fittings for any such application requiring nonconductive Hose, including but not limited to applications near high voltage electric lines, unless (i) the application is expressly approved in the Parker technical publication for the product, (ii) the Hose is marked "nonconductive", and (iii) the manufacturer of the equipment on which the Hose is to be used specifically approves the particular Parker Hose and Fittings for such use.

2.1.2 Electrically Conductive Hose: Parker manufactures special Hose for certain applications that require electrically conductive



Hose. Parker manufactures special Hose for conveying paint in airless paint spraying applications. This Hose is labeled “Electrically Conductive Airless Paint Spray Hose” on its layline and packaging. This Hose must be properly connected to the appropriate Parker Fittings and properly grounded in order to dissipate dangerous static charge buildup, which occurs in all airless paint spraying applications. Do not use any other Hose for airless paint spraying, even if electrically conductive. Use of any other Hose or failure to properly connect the Hose can cause a fire or an explosion resulting in death, personal injury, and property damage. Parker manufactures a special Hose for certain compressed natural gas (“CNG”) applications where static electricity buildup may occur. Parker CNG Hose assemblies comply with the requirements of ANSI/IAS NGV 4.2-1999; CSA 12.52-M99, “Hoses for Natural Gas Vehicles and Dispensing Systems” (www.ansi.org). This Hose is labeled “Electrically Conductive for CNG Use” on its layline and packaging. This Hose must be properly connected to the appropriate Parker Fittings and properly grounded in order to dissipate dangerous static charge buildup, which occurs in, for example, high velocity CNG dispensing or transfer. Do not use any other Hose for CNG applications where static charge buildup may occur, even if electrically conductive. Use of other Hoses in CNG applications or failure to properly connect or ground this Hose can cause a fire or an explosion resulting in death, personal injury, and property damage. Care must also be taken to protect against CNG permeation through the Hose wall. See section 2.6, Permeation, for more information. Parker CNG Hose is intended for dispenser and vehicle use at a maximum temperature of 180°F (82°C). Parker CNG Hose should not be used in confined spaces or unventilated areas or areas exceeding 180°F (82°C). Final assemblies must be tested for leaks. CNG Hose Assemblies should be tested on a monthly basis for conductivity per ANSI/IAS NGV 4.2-1999; CSA 12.52-M99. Parker manufactures special Hose for aerospace in flight applications. Aerospace in flight applications employing Hose to transmit fuel, lubricating fluids and hydraulic fluids require a special Hose with a conductive inner tube. This Hose for in flight applications is available only from Parker’s Stratoflex Products Division. Do not use any other Parker Hose for in flight applications, even if electrically conductive. Use of other Hoses for in flight applications or failure to properly connect or ground this Hose can cause a fire or an explosion resulting in death, personal injury and property damage. These Hose assemblies for in flight applications must meet all applicable aerospace industry, aircraft engine and aircraft requirements.

2.2 Pressure: Hose selection must be made so that the published maximum working pressure of the Hose and Fittings are equal to or greater than the maximum system pressure. The maximum working pressure of a Hose Assembly is the lower of the respective published maximum working pressures of the Hose and the Fittings used. Surge pressures or peak transient pressures in the system must be below the published maximum working pressure for the Hose. Surge pressures and peak pressures can usually only be determined by sensitive electrical instrumentation that measures and indicates pressures at millisecond intervals. Mechanical pressure gauges indicate only average pressures and cannot be used to determine surge pressures or peak transient pressures. Published burst pressure ratings for Hose is for manufacturing test purposes only and is no indication that the Product can be used in applications at the burst pressure or otherwise above the published maximum recommended working pressure.

2.3 Suction: Hoses used for suction applications must be selected to ensure that the Hose will withstand the vacuum and pressure of the system. Improperly selected Hose may collapse in suction application.

2.4 Temperature: Be certain that fluid and ambient temperatures, both steady and transient, do not exceed the limitations of the Hose. Temperatures below and above the recommended limit can degrade Hose to a point where a failure may occur and

release fluid. Properly insulate and protect the Hose Assembly when routing near hot objects (e.g. manifolds). Do not use any Hose in any application where failure of the Hose could result in the conveyed fluids (or vapors or mist from the conveyed fluids) contacting any open flame, molten metal, or other potential fire ignition source that could cause burning or explosion of the conveyed fluids or vapors.

2.5 Fluid Compatibility: Hose Assembly selection must assure compatibility of the Hose tube, cover, reinforcement, and Fittings with the fluid media used. See the fluid compatibility chart in the Parker publication for the product being considered or used. This information is offered only as a guide. Actual service life can only be determined by the end user by testing under all extreme conditions and other analysis. Hose that is chemically compatible with a particular fluid must be assembled using Fittings and adapters containing likewise compatible seals.

2.6 Permeation: Permeation (that is, seepage through the Hose) will occur from inside the Hose to outside when Hose is used with gases, liquid and gas fuels, and refrigerants (including but not limited to such materials as helium, diesel fuel, gasoline, natural gas, or LPG). This permeation may result in high concentrations of vapors which are potentially flammable, explosive, or toxic, and in loss of fluid. Dangerous explosions, fires, and other hazards can result when using the wrong Hose for such applications. The system designer must take into account the fact that this permeation will take place and must not use Hose if this permeation could be hazardous. The system designer must take into account all legal, government, insurance, or any other special regulations which govern the use of fuels and refrigerants. Never use a Hose even though the fluid compatibility is acceptable without considering the potential hazardous effects that can result from permeation through the Hose Assembly. Permeation of moisture from outside the Hose to inside the Hose will also occur in Hose assemblies, regardless of internal pressure. If this moisture permeation would have detrimental effects (particularly, but not limited to refrigeration and air conditioning systems), incorporation of sufficient drying capacity in the system or other appropriate system safeguards should be selected and used.

2.7 Size: Transmission of power by means of pressurized fluid varies with pressure and rate of flow. The size of the components must be adequate to keep pressure losses to a minimum and avoid damage due to heat generation or excessive fluid velocity.

2.8 Routing: Attention must be given to optimum routing to minimize inherent problems (kinking or flow restriction due to Hose collapse, twisting of the Hose, proximity to hot objects or heat sources). For additional routing recommendations see SAE J1273 and ISO 17165-2. Hose Assemblies have a finite life and if possible, should be installed in a manner that allows for ease of inspection and future replacement. Rubber Hose because of its relative short life, should not be used in residential and commercial buildings for HVAC (heating, ventilating and air conditioning) applications.

2.9 Environment: Care must be taken to ensure that the Hose and Fittings are either compatible with or protected from the environment (that is, surrounding conditions) to which they are exposed. Environmental conditions including but not limited to ultraviolet radiation, sunlight, heat, ozone, moisture, water, salt water, chemicals and air pollutants can cause degradation and premature failure.

2.10 Mechanical Loads: External forces can significantly reduce Hose life or cause failure. Mechanical loads which must be considered include excessive flexing, twist, kinking, tensile or side loads, bend radius, and vibration. Use of swivel type Fittings or adapters may be required to ensure no twist is put into the Hose. Unusual applications may require special testing prior to Hose selection.

2.11 Physical Damage: Care must be taken to protect Hose from wear, snagging, kinking, bending smaller than minimum bend radius and cutting, any of which can cause premature Hose failure.

Any Hose that has been kinked or bent to a radius smaller than the minimum bend radius, and any Hose that has been cut or is cracked or is otherwise damaged should be removed and discarded.

2.12 Proper End Fitting: See instructions 3.2 through 3.5. These recommendations may be substantiated by testing to industry standards such as SAE J517 for hydraulic applications, or MIL-A-5070, AS1339, or AS3517 for Hoses from Parker's Stratoflex Products Division for aerospace applications.

2.13 Length: When establishing a proper Hose length, motion absorption, Hose length changes due to pressure, and Hose and machine tolerances and movement must be considered.

2.14 Specifications and Standards: When selecting Hose and Fittings, government, industry, and Parker specifications and recommendations must be reviewed and followed as applicable.

2.15 Hose Cleanliness: Hose components may vary in cleanliness levels. Care must be taken to ensure that the Hose Assembly selected has an adequate level of cleanliness for the application.

2.16 Fire Resistant Fluids: Some fire resistant fluids that are to be conveyed by Hose require use of the same type of Hose as used with petroleum base fluids. Some such fluids require a special Hose, while a few fluids will not work with any Hose at all. See instructions 2.5 and 1.5. The wrong Hose may fail after a very short service. In addition, all liquids but pure water may burn fiercely under certain conditions, and even pure water leakage may be hazardous.

2.17 Radiant Heat: Hose can be heated to destruction without contact by such nearby items as hot manifolds or molten metal. The same heat source may then initiate a fire. This can occur despite the presence of cool air around the Hose.

2.18 Welding or Brazing: When using a torch or arc welder in close proximity to hydraulic lines, the hydraulic lines should be removed or shielded with appropriate fire resistant materials. Flame or weld spatter could burn through the Hose and possibly ignite escaping fluid resulting in a catastrophic failure. Heating of plated parts, including Hose Fittings and adapters, above 450°F (232°C) such as during welding, brazing or soldering may emit deadly gases.

2.19 Atomic Radiation: Atomic radiation affects all materials used in Hose assemblies. Since the long-term effects may be unknown, do not expose Hose assemblies to atomic radiation.

2.20 Aerospace Applications: The only Hose and Fittings that may be used for in flight aerospace applications are those available from Parker's Stratoflex Products Division. Do not use any other Hose or Fittings for in flight applications. Do not use any Hose or Fittings from Parker's Stratoflex Products Division with any other Hose or Fittings, unless expressly approved in writing by the engineering manager or chief engineer of Stratoflex Products Division and verified by the user's own testing and inspection to aerospace industry standards.

2.21 Unlocking Couplings: Ball locking couplings or other Fittings with quick disconnect ability can unintentionally disconnect if they are dragged over obstructions, or if the sleeve or other disconnect member, is bumped or moved enough to cause disconnect. Threaded Fittings should be considered where there is a potential for accidental uncoupling.

### 3.0 HOSE AND FITTING ASSEMBLY AND INSTALLATION INSTRUCTIONS

3.1 Component Inspection: Prior to assembly, a careful examination of the Hose and Fittings must be performed. All components must be checked for correct style, size, catalog number, and length. The Hose must be examined for cleanliness, obstructions, blisters, cover looseness, kinks, cracks, cuts or any other visible defects. Inspect the Fitting and sealing surfaces for burrs, nicks, corrosion or other imperfections. Do NOT use any component that displays any signs of nonconformance.

3.2 Hose and Fitting Assembly: Do not assemble a Parker Fitting on a Parker Hose that is not specifically listed by Parker for that Fitting, unless authorized in writing by the engineering manager or chief engineer of the appropriate Parker division. Do not assemble a Parker Fitting on another manufacturer's Hose or a Parker Hose on another manufacturer's Fitting unless (i) the engineering manager or chief engineer of the appropriate Parker division approves the Assembly in writing or that combination is expressly approved in the appropriate Parker literature for the specific Parker product, and (ii) the user verifies the Assembly and the application through analysis and testing. For Parker Hose that does not specify a Parker Fitting, the user is solely responsible for the selection of the proper Fitting and Hose Assembly procedures. See instruction 1.4. To prevent the possibility of problems such as leakage at the Fitting or system contamination, it is important to completely remove all debris from the cutting operation before installation of the Fittings. The Parker published instructions must be followed for assembling the Fittings on the Hose. These instructions are provided in the Parker Fitting catalog for the specific Parker Fitting being used, or by calling 1 800 CPARKER, or at [www.parker.com](http://www.parker.com).

3.3 Related Accessories: Do not crimp or swage any Parker Hose or Fitting with anything but the listed swage or crimp machine and dies in accordance with Parker published instructions. Do not crimp or swage another manufacturer's Fitting with a Parker crimp or swage die unless authorized in writing by the engineering manager or chief engineer of the appropriate Parker division.

3.4 Parts: Do not use any Parker Fitting part (including but not limited to socket, shell, nipple, or insert) except with the correct Parker mating parts, in accordance with Parker published instructions, unless authorized in writing by the engineering manager or chief engineer of the appropriate Parker division.

3.5 Field Attachable/Permanent: Do not reuse any field attachable Hose Fitting that has blown or pulled off a Hose. Do not reuse a Parker permanent Hose Fitting (crimped or swaged) or any part thereof. Complete Hose Assemblies may only be reused after proper inspection under section 4.0. Do not assemble Fittings to any previously used hydraulic Hose that was in service, for use in a fluid power application.

3.6 Pre-Installation Inspection: Prior to installation, a careful examination of the Hose Assembly must be performed. Inspect the Hose Assembly for any damage or defects. DO NOT use any Hose Assembly that displays any signs of nonconformance.

3.7 Minimum Bend Radius: Installation of a Hose at less than the minimum listed bend radius may significantly reduce the Hose life. Particular attention must be given to preclude sharp bending at the Hose to Fitting juncture. Any bending during installation at less than the minimum bend radius must be avoided. If any Hose is kinked during installation, the Hose must be discarded.

3.8 Twist Angle and Orientation: Hose Assembly installation must be such that relative motion of machine components does not produce twisting.

3.9 Securement: In many applications, it may be necessary to restrain, protect, or guide the Hose to protect it from damage by unnecessary flexing, pressure surges, and contact with other mechanical components. Care must be taken to ensure such restraints do not introduce additional stress or wear points.

3.10 Proper Connection of Ports: Proper physical installation of the Hose Assembly requires a correctly installed port connection insuring that no twist or torque is transferred to the Hose when the Fittings are being tightened or otherwise during use..

3.11 External Damage: Proper installation is not complete without insuring that tensile loads, side loads, kinking, flattening, potential abrasion, thread damage or damage to sealing surfaces are corrected or eliminated. See instruction 2.10.

3.12 System Checkout: All air entrapment must be eliminated and the system pressurized to the maximum system pressure (at or below the Hose maximum working pressure) and checked

for proper function and freedom from leaks. Personnel must stay out of potential hazardous areas while testing and using.

3.13 Routing: The Hose Assembly should be routed in such a manner so if a failure does occur, the escaping media will not cause personal injury or property damage. In addition, if fluid media comes in contact with hot surfaces, open flame or sparks, a fire or explosion may occur. See section 2.4.

3.14 Ground Fault Equipment Protection Devices (GFEPDs): **WARNING! Fire and Shock Hazard:** To minimize the danger of fire if the heating cable of a Multitube bundle is damaged or improperly installed, use a Ground Fault Equipment Protection Device. Electrical fault currents may be insufficient to trip a conventional circuit breaker. For ground fault protection, the IEEE 515:1989 (www.ansi.org) standard for heating cables recommends the use of GFEPDs with a nominal 30 milliampere trip level for "piping systems in classified areas, those areas requiring a high degree of maintenance, or which may be exposed to physical abuse or corrosive atmospheres".

**4.0 HOSE AND FITTING MAINTENANCE AND REPLACEMENT INSTRUCTIONS**

4.1 Even with proper selection and installation, Hose life may be significantly reduced without a continuing maintenance program. The severity of the application, risk potential from a possible Hose failure, and experience with any Hose failures in the application or in similar applications should determine the frequency of the inspection and the replacement for the Products so that Products are replaced before any failure occurs. A maintenance program must be established and followed by the user and, at minimum, must include instructions 4.2 through 4.7.

4.2 Visual Inspection Hose/Fitting: Any of the following conditions require immediate shut down and replacement of the Hose Assembly:

- Fitting slippage on Hose;
- Damaged, cracked, cut or abraded cover (any reinforcement exposed);
- Hard, stiff, heat cracked, or charred Hose;
- Cracked, damaged, or badly corroded Fittings;
- Leaks at Fitting or in Hose;
- Kinked, crushed, flattened or twisted Hose; and
- Blistered, soft, degraded, or loose cover.

4.3 Visual Inspection All Other: The following items must be tightened, repaired, corrected or replaced as required:

- Leaking port conditions;
- Excess dirt buildup;
- Worn clamps, guards or shields; and
- System fluid level, fluid type, and any air entrapment.

4.4 Functional Test: Operate the system at maximum operating pressure and check for possible malfunctions and leaks. Personnel must avoid potential hazardous areas while testing and using the system. See section 2.2.

4.5 Replacement Intervals: Hose assemblies and elastomeric seals used on Hose Fittings and adapters will eventually age, harden, wear and deteriorate under thermal cycling and compression set. Hose Assemblies and elastomeric seals should be inspected and replaced at specific replacement intervals, based on previous service life, government or industry recommendations, or when failures could result in unacceptable downtime, damage, or injury risk. See section 1.2. Hose and Fittings may be subjected to internal mechanical and/or chemical wear from the conveying fluid and may fail without warning. The user must determine the product life under such circumstances by testing. Also see section 2.5. See section 1.2.

4.6 Hose Inspection and Failure: Hydraulic power is accomplished by utilizing high pressure fluids to transfer energy and do work. Hoses, Fittings and Hose Assemblies all contribute to this by transmitting fluids at high pressures. Fluids under pressure can be dangerous and potentially lethal and, therefore, extreme caution must be exercised when working with fluids under pressure and handling the Hoses transporting the fluids. From

time to time, Hose Assemblies will fail if they are not replaced at proper time intervals. Usually these failures are the result of some form of misapplication, abuse, wear or failure to perform proper maintenance. When Hoses fail, generally the high pressure fluids inside escape in a stream which may or may not be visible to the user. Under no circumstances should the user attempt to locate the leak by "feeling" with their hands or any other part of their body. High pressure fluids can and will penetrate the skin and cause severe tissue damage and possibly loss of limb. Even seemingly minor hydraulic fluid injection injuries must be treated immediately by a physician with knowledge of the tissue damaging properties of hydraulic fluid. If a Hose failure occurs, immediately shut down the equipment and leave the area until pressure has been completely released from the Hose Assembly. Simply shutting down the hydraulic pump may or may not eliminate the pressure in the Hose Assembly. Many times check valves, etc., are employed in a system and can cause pressure to remain in a Hose Assembly even when pumps or equipment are not operating. Tiny holes in the Hose, commonly known as pinholes, can eject small, dangerously powerful but hard to see streams of hydraulic fluid. It may take several minutes or even hours for the pressure to be relieved so that the Hose Assembly may be examined safely. Once the pressure has been reduced to zero, the Hose Assembly may be taken off the equipment and examined. It must always be replaced if a failure has occurred. Never attempt to patch or repair a Hose Assembly that has failed. Consult the nearest Parker distributor or the appropriate Parker division for Hose Assembly replacement information. Never touch or examine a failed Hose Assembly unless it is obvious that the Hose no longer contains fluid under pressure. The high pressure fluid is extremely dangerous and can cause serious and potentially fatal injury.

4.7 Elastomeric seals: Elastomeric seals will eventually age, harden, wear and deteriorate under thermal cycling and compression set. Elastomeric seals should be inspected and replaced.

4.8 Refrigerant gases: Special care should be taken when working with refrigeration systems. Sudden escape of refrigerant gases can cause blindness if the escaping gases contact the eye and can cause freezing or other severe injuries if it contacts any other portion of the body.

4.9 Compressed natural gas (CNG): Parker CNG Hose Assemblies should be tested after installation and before use, and at least on a monthly basis per ANSI/IAS NGV 4.2-1999; CSA 12.52-M99 Section 4.2 "Visual Inspection Hose/ Fitting". The recommended procedure is to pressurize the Hose and check for leaks and to visually inspect the Hose for damage. Caution: Matches, candles, open flame or other sources of ignition shall not be used for Hose inspection. Leak check solutions should be rinsed off after use.

**5.0 HOSE STORAGE**

5.1 Age Control: Hose and Hose Assemblies must be stored in a manner that facilitates age control and first-in and first-out usage based on manufacturing date of the Hose and Hose Assemblies. The shelf life of rubber Hose or Hose Assemblies that have passed visual inspection and a proof test is 10 years (40 quarters) from the date of manufacture. The shelf life of thermoplastic and polytetrafluoroethylene Hose or Hose Assemblies is considered to be unlimited.

5.2 Storage: Stored Hose and Hose Assemblies must not be subjected to damage that could reduce their expected service life and must be placed in a cool, dark and dry area with the ends capped. Stored Hose and Hose Assemblies must not be exposed to temperature extremes, ozone, oils, corrosive liquids or fumes, solvents, high humidity, rodents, insects, ultraviolet light, electromagnetic fields or radioactive materials.





aerospace  
climate control  
electromechanical  
filtration  
fluid & gas handling  
hydraulics  
pneumatics  
process control  
sealing & shielding



# Hydraulic Hoses, Fittings and Equipment

Low pressure



ENGINEERING YOUR SUCCESS.

# Low-Pressure Push-Lok®

The self-grip hose system for low-pressure applications

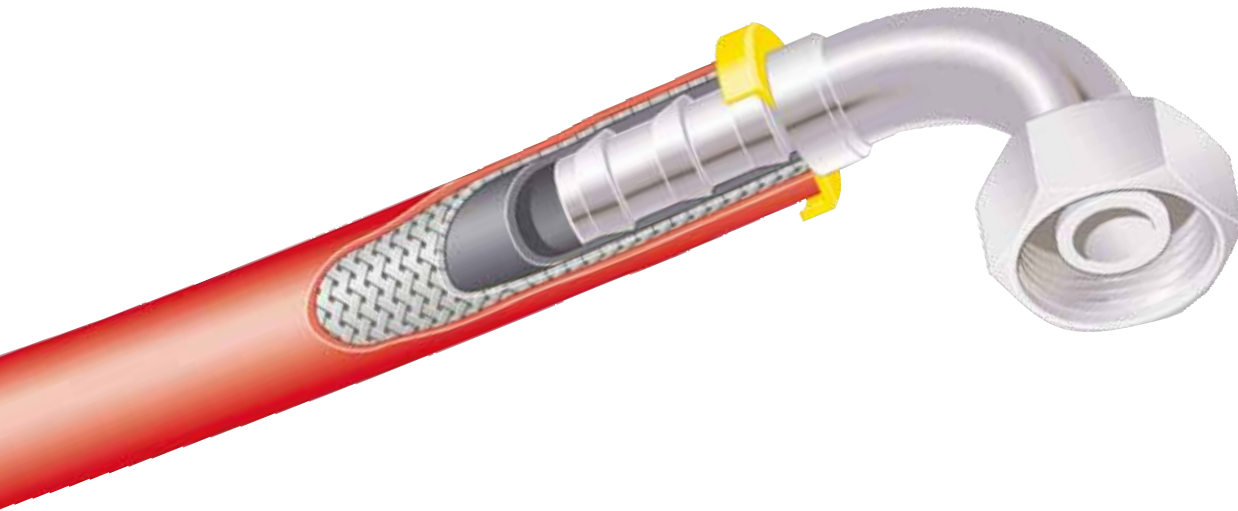

## One fitting series for all hose types

with DIN, BSP, SAE, JIC and ORFS connections in brass, steel and stainless steel



## Wide variety of hose types

6 rubber hose types

- 801Plus** for a variety of applications
- 804** for high-temperature water/phosphate ester fluids
- 821FR** with fire-retardant hose cover
- 831** ideal for petroleum-based fluids
- 836** for high oil temperatures
- 837BM** for a variety of applications including automotive

2 thermoplastic hose types

- 830M** for a variety of applications including automotive
- 838M** for non-conductive applications

1 hybrid hose type

- 837PU-Plus** for a variety of applications including automotive

## Applications

Push-Lok® hoses offer variety, excellent performance and durability for the following applications



## 8 different colours

- easy identification
- simple production processes
  - one colour for one particular medium
- easy control of maintenance intervals
- simple stock planning in different departments



## Easy assembly – no tools or clamps required

### Push-Lok® assembly (1a, b)

- Cut the hose with a sharp knife
- Push the nipple into the hose – that's all!



### Push-Lok® disassembly (2a, b)

- Cut lengthwise along a line at approximately a 20° angle from the centre line of the hose. The cut should be approximately 2 cm long. Be careful not to nick barbs when cutting the hose.
- Grip hose and give a sharp downward tug to disengage from fitting.
- Before re-using the nipple, please check it for any damage.













# Push-Lok® Hoses and Fittings

Low pressure	Push-Lok	Hose	<b>801Plus</b>	B1a-1
			<b>804</b>	B1a-2
			<b>821FR</b>	B1a-3
			<b>830M</b>	B1a-4
			<b>831</b>	B1a-5
			<b>836</b>	B1a-6
			<b>837BM</b>	B1a-7
			<b>837PU</b>	B1a-8
			<b>838M</b>	B1a-9
	Fittings 82 series	<b>DIN - Metric</b>	B1b-1 – B1b-8	
		<b>BSP</b>	B1b-9 – B1b-11	
		<b>SAE</b>	B1b-12 – B1b-15	
		<b>ORFS</b>	B1b-16	
		<b>Others</b>	B1b-17 – B1b-21	
	Assembly Instructions	B1b-22		
	Assembly Tools	B1b-22		

## Multipurpose

<p><b>801</b> B1a-1</p>  <p><b>Push-Lok Plus</b> For a variety of applications</p>	<p><b>830M</b> B1a-4</p>  <p><b>Push-Lok</b> For a variety of applications including automotive</p>	<p><b>831</b> B1a-5</p>  <p><b>Push-Lok</b> Ideal for petroleum based fluids</p>	<p><b>837BM</b> B1a-7</p>  <p><b>Push-Lok</b> For a variety of applications including automotive</p>
<p><b>837PU-Plus</b> B1a-8</p>  <p><b>Hybrid Push-Lok</b> For a variety of applications including automotive</p>			

## Phosphate Ester

<p><b>804</b> B1a-2</p>  <p><b>Push-Lok</b> For high temperature water and phosphate ester fluid</p>
---

## Fire retardant

<p><b>821FR</b> B1a-3</p>  <p><b>Push-Lok</b> With fire retardant hose cover</p>
---

## High temperature

<p><b>836</b> B1a-6</p>  <p><b>Push-Lok</b> For high oil temperatures</p>
--

## Non-conductive

<p><b>838M</b> B1a-9</p>  <p><b>Push-Lok</b> For non-conductive applications</p>
---

# 801

## Push-Lok Plus

For a variety of applications

### Primary Applications

All Markets: For light applications  
Paper and Pulp: For water / air applications

### Restrictions

Not permitted for use in air brake systems.  
Not suitable for high dynamic pulsation systems.  
Not recommended for fuels (petrol, diesel etc.).  
Not recommended for mineral based hydraulic and lubricating oils.

### Construction

Tube: Synthetic rubber  
Reinforcement: High-tensile fibre braid  
Cover: High performance synthetic rubber in different colours

Temperature Range ..... -40 °C up to +100 °C

Exception: Air ..... max. +70 °C  
Water ..... max. +85 °C



- Very flexible
- Wide range of colours
- Available up to size -16

### Recommended Fluids

Air, dry air, water, water-oil-emulsions and water-glycol-emulsions.  
Consult the chemical compatibility section on pages **Ab-22** to **Ab-30** for more detailed information.

### Fitting Series



Part Number	Hose I.D.				Hose O.D. mm	Pressure Rating				Vaccum kilo Pascal *1 kPa	min. bend radius mm	weight kg
	DN	Inch	Size	mm		max. working pressure		min. burst pressure				
						MPa	psi	MPa	psi			
801-4-XXX-RL	6	1/4	-4	6.3	12.7	2.4	350	9.7	1400	95	65	0.13
801-6-XXX-RL	10	3/8	-6	9.5	15.9	2.4	350	9.7	1400	95	75	0.16
801-8-XXX-RL	12	1/2	-8	12.7	19.8	2.1	300	8.4	1200	95	125	0.27
801-10-XXX-RL	16	5/8	-10	15.9	23.0	2.1	300	8.4	1200	51	150	0.28
801-12-XXX-RL	20	3/4	-12	19.1	26.2	2.1	300	8.4	1200	51	180	0.36
801-16-XXX-RL	25	1	-16	25.4	32.5	1.4	200	5.6	800	51	250	0.55

\*1 = the vacuum values listed in the table are vacuum pressure values in kPa. For an absolute value subtract the table value from 101 kPa  
Note: when ordering, specify Push-Lok hose part number, followed by size, followed by colour. Example: 801-4-XXX-RL

XXX = BLK = black  
BLU = blue  
RED = red  
GRN = green  
GRA = grey  
WHT = white  
YEL = yellow



Example: 801-4-GRN-RL (green)

RL = only available on reels

801-16-XXX-RL is only available in grey or black

# 804

## Push-Lok

For high temperature water and phosphate ester fluid

### Primary Applications

Injection Moulding: For special tempering circuits.

### Restrictions

Not permitted for use in air brake systems.  
Not suitable for high dynamic pulsation systems.  
Do not allow tube to contact any petroleum based fluids.

### Construction

Tube: EPDM material  
Reinforcement: High-tensile fibre braid  
Cover: Black EPDM material

Temperature Range ..... up to +80 °C  
Exception: Air ..... max. +70 °C  
Water ..... max. +93 °C



- For hot water up to +93 °C
- For phosphate ester fluids

### Recommended Fluids

Phosphate ester based hydraulic fluids, water, water glycol emulsions, air. Use liquid soap as lubricant. Consult the chemical compatibility section on pages **Ab-22** to **Ab-30** for more detailed information.

### Fitting Series



Part Number	Hose I.D.				Hose O.D. mm	Pressure Rating				Vacuum kilo Pascal *1 kPa	min. bend radius mm	weight kg
	DN	Inch	Size	mm		max. working pressure		min. burst pressure				
						MPa	psi	MPa	psi			
804-4-RL	6	1/4	-4	6.3	12.7	1.7	250	6.8	1000	51	65	0.13
804-6-RL	10	3/8	-6	9.5	15.9	1.7	250	6.8	1000	51	75	0.16
804-8-RL	12	1/2	-8	12.7	19.8	1.7	250	6.8	1000	51	130	0.27
804-12-RL	20	3/4	-12	19.1	26.2	1.7	250	6.8	1000	51	180	0.28

RL = only available on reels

# 821FR

## Push-Lok

With fire retardant hose cover



- Fire retardant hose cover
- Very flexible
- For high level air temperatures

### Primary Applications

All Markets: For a variety of applications

### Restrictions

Not permitted for use in air brake systems.  
Not suitable for high dynamic pulsation systems.  
Not recommended for fuels (petrol, diesel etc.)

### Construction

Tube: Synthetic PKR-rubber  
Reinforcement: High-tensile fibre braid  
Cover: A fire retardant special fiber outer cover

Temperature Range ..... -40 °C up to +100 °C

Exception: Air ..... max. +100 °C  
Water ..... max. +85 °C

### Recommended Fluids

Mineral based hydraulic and lubricating oils, coolant, antifreeze, air, water and water-oil emulsions.  
Consult the chemical compatibility section on pages **Ab-22** to **Ab-30** for more detailed information.

### Fitting Series



Part Number	Hose I.D.				Hose O.D. mm	Pressure Rating				Vacuum kilo Pascal *1 kPa	min. bend radius mm	weight kg
	DN	Inch	Size	mm		max. working pressure		min. burst pressure				
						MPa	psi	MPa	psi			
821FR-4-XXX-RL	6	1/4	-4	6.3	12.7	2.4	350	9.7	1400	95	65	0.12
821FR-6-XXX-RL	10	3/8	-6	9.5	15.9	2.0	300	8.3	1200	95	75	0.16
821FR-8-XXX-RL	12	1/2	-8	12.7	19.8	2.0	300	8.3	1200	95	130	0.18
821FR-12-XXX-RL	20	3/4	-12	19.0	26.2	1.7	250	6.8	1000	95	180	0.33

\*1 = the vacuum values listed in the table are vacuum pressure values in kPa. For an absolute value subtract the table value from 101 kPa  
Note: when ordering, specify Push-Lok hose part number, followed by size, followed by colour. Example: 821FR-4-XXX-RL

XXX = BLK = black  
BLU = blue  
GRN = green  
WHT = white  
BRN = brown



Example: 821FR-4-GRN-RL (green)  
RL = only available on reels

# 830M

## Push-Lok

For a variety of applications including automotive

### Primary Applications

All Markets: For a variety of applications  
Robot and Automotive market:  
For hose bundle systems

### Restrictions

Not permitted for use in air brake systems.  
Not suitable for high dynamic pulsation systems.  
Not recommended for fuels (petrol, diesel etc.)

### Construction

Tube: Polyurethane material  
Reinforcement: High-tensile fibre braid  
Cover: High performance polyurethane material in different colours

Temperature Range ..... -40 °C up to +80 °C



- Chemical resistant for a wide range of fluids
- High abrasion resistance
- Free of wetting disturbing substances (LABS free)
- Small OD and bend radii
- Excellent UV and ozone resistance

### Recommended Fluids

Mineral based hydraulic and lubricating oils, coolant, antifreeze, air, water and water-oil emulsions.  
Consult the chemical compatibility section on pages **Ab-22** to **Ab-30** for more detailed information.

### Fitting Series



Part Number	Hose I.D.				Hose O.D.		Pressure Rating				Vaccum kilo Pascal *1	min. bend radius	weight
	DN	Inch	Size	mm	mm	max. working pressure		min. burst pressure					
						MPa	psi	MPa	psi				
830M-4-XXX-RL	6	1/4	-4	6.3	10.7	1.6	232	6.4	928	10	30	0.08	
830M-6-XXX-RL	10	3/8	-6	9.5	14.9	1.6	232	6.4	928	10	50	0.13	
830M-8-XXX-RL	12	1/2	-8	12.7	19.1	1.6	232	6.4	928	10	70	0.20	
830M-10-XXX-RL	16	5/8	-10	16.0	23.0	1.6	232	6.4	928	10	90	0.26	
830M-12-XXX-RL	20	3/4	-12	19.0	26.0	1.6	232	6.4	928	10	110	0.31	

\*1 = the vacuum values listed in the table are vacuum pressure values in kPa. For an absolute value subtract the table value from 101 kPa  
Note: when ordering, specify Push-Lok hose part number, followed by size, followed by colour. Example: 830M-4-XXX-RL

XXX = BLK = black  
BLU = blue  
RED = red  
GRN = green



Example: 830M-4-GRN-RL (green)  
RL = only available on reels

# 831

## Push-Lok

Ideal for petroleum based fluids



- Max. working pressure up to 2.4 MPa
- High temperature level for petroleum based fluids
- Nitrile (NBR) inner tube – extended fluid compatibility

### Primary Applications

All Markets: For a wide range of fluids

### Restrictions

Not permitted for use in air brake systems.  
Not suitable for high dynamic pulsation systems.  
Not recommended for fuels (petrol, diesel etc.)

### Construction

Tube: Nitrile (NBR)  
Reinforcement: High-tensile fibre braid  
Cover: High performance synthetic rubber in different colours

### Recommended Fluids

Mineral based hydraulic and lubricating oils, coolant, antifreeze, air, water and water-oil emulsions.  
Consult the chemical compatibility section on pages **Ab-22** to **Ab-30** for more detailed information.

Temperature Range ..... -40 °C up to +100 °C

Exception: Air ..... max. +70 °C  
Water ..... max. +85 °C

### Fitting Series



Part Number	Hose I.D.				Hose O.D. mm	Pressure Rating				Vacuum kilo Pascal *1 kPa	min. bend radius mm	weight kg
	DN	Inch	Size	mm		max. working pressure		min. burst pressure				
						MPa	psi	MPa	psi			
831-4-XXX-RL	6	1/4	-4	6.3	12.7	2.4	350	9.7	1400	95	65	0.13
831-6-XXX-RL	10	3/8	-6	9.5	15.9	2.0	300	8.3	1200	95	75	0.16
831-8-XXX-RL	12	1/2	-8	12.7	19.8	2.0	300	8.3	1200	95	130	0.27
831-10-XXX-RL	16	5/8	-10	15.9	23.0	2.0	300	8.3	1200	51	150	0.28
831-12-XXX-RL	20	3/4	-12	19.1	26.2	2.0	300	8.3	1200	51	180	0.36
831-16-XXX-RL	25	1	-16	25.4	32.5	1.4	200	5.5	800	51	250	0.37

\*1 = the vacuum values listed in the table are vacuum pressure values in kPa. For an absolute value subtract the table value from 101 kPa  
Note: when ordering, specify Push-Lok hose part number, followed by size, followed by colour. Example: 831-4-XXX-RL

XXX = BLK = black  
BLU = blue  
RED = red  
GRN = green



Example: 831-4-GRN-RL (green)  
RL = only available on reels

# 836

## Push-Lok

For high oil temperatures

### Primary Applications

All Markets: Special high temperature applications

### Type Approvals

Details please find on pages **Ab-14** and **Ab-15**

### Restrictions

Not permitted for use in air brake systems.  
Not suitable for high dynamic pulsation systems.  
Not recommended for fuels (petrol, diesel etc.)

### Construction

Tube: Synthetic PKR rubber  
Reinforcement: High-tensile fibre braid  
Cover: Blue synthetic PKR rubber

Temperature Range ..... -48 °C up to +150 °C

Exception: Air ..... max. +100 °C

Water ..... max. +85 °C



- Max. oil temperature up to +150 °C
- Blue hose cover

### Recommended Fluids

Mineral based hydraulic and lubricating oils, coolant, antifreeze, air, water and water-oil emulsions.  
Consult the chemical compatibility section on pages **Ab-22** to **Ab-30** for more detailed information.

### Fitting Series



Part Number	Hose I.D.				Hose O.D. mm	Pressure Rating				Vacuum kilo Pascal *1 kPa	min. bend radius mm	weight kg
	DN	Inch	Size	mm		max. working pressure		min. burst pressure				
						MPa	psi	MPa	psi			
836-4-RL	6	1/4	-4	6.3	12.7	1.7	250	6.8	1000	95	65	0.13
836-6-RL	10	3/8	-6	9.5	15.7	1.7	250	6.8	1000	95	75	0.16
836-8-RL	12	1/2	-8	12.7	19.8	1.7	250	6.8	1000	95	130	0.27
836-10-RL	16	5/8	-10	15.9	23.1	1.7	250	6.8	1000	51	150	0.28
836-12-RL	20	3/4	-12	19.1	26.2	1.7	250	6.8	1000	51	180	0.36

\*1 = the vacuum values listed in the table are vacuum pressure values in kPa. For an absolute value subtract the table value from 101 kPa  
RL = only available on reels



# 837BM

## Push-Lok

For a variety of applications including automotive

### Primary Applications

All Markets: For a variety of applications  
Automotive: For water / air applications

### Restrictions

Not permitted for use in air brake systems  
Not suitable for high dynamic pulsation systems  
Not recommended for fuels (petrol, diesel etc.)  
Not recommended for mineral based hydraulic and lubricating oils

### Construction

Tube: Synthetic rubber  
Reinforcement: High-tensile fibre braid  
Cover: High performance synthetic rubber in different colours

Temperature Range ..... -40 °C up to +100 °C

Exception: Air ..... max. +70 °C  
Water ..... max. +85 °C



- High level of hose flexibility
- High abrasion resistance
- Free from wetting disturbing substances
- Low push-in forces

### Recommended Fluids

Air, dry air, water, water-oil-emulsions and water-glycol-emulsions.

Consult the chemical compatibility section on pages **Ab-22** to **Ab-30** for more detailed information.

### Fitting Series



Part Number	Hose I.D.				Hose O.D.		Pressure Rating				Vaccum kilo Pascal *1	min. bend radius	weight
	DN	Inch	Size	mm	mm	max. working pressure		min. burst pressure					
						MPa	psi	MPa	psi				
837BM-4-XXX-RL	6	1/4	-4	6.3	12.7	1.6	235	6.4	940	95	65	0.13	
837BM-6-XXX-RL	10	3/8	-6	9.5	15.9	1.6	235	6.4	940	95	75	0.16	
837BM-8-XXX-RL	12	1/2	-8	12.7	19.8	1.6	235	6.4	940	95	130	0.27	
837BM-10-XXX-RL	16	5/8	-10	15.9	23.0	1.6	235	6.4	940	51	150	0.28	
837BM-12-XXX-RL	20	3/4	-12	19.1	26.2	1.6	235	6.4	940	51	180	0.36	
837BM-16-XXX-RL	25	1	-16	25.4	32.5	1.4	200	5.6	800	51	250	0.55	

\*1 = the vacuum values listed in the table are vacuum pressure values in kPa. For an absolute value subtract the table value from 101 kPa  
Note: when ordering, specify Push-Lok hose part number, followed by size, followed by colour. Example: 837BM-4-XXX-RL

XXX = BLK = black  
BLU = blue  
RED = red  
GRN = green  
GRA = grey



Example: 837BM-4-GRN-RL (green)  
RL = only available on reels

## 837PU-Plus

### Hybrid Push-Lok

For a variety of applications including automotive

#### Primary Applications

- All Markets: For high demand applications  
For energy chain systems
- Robot and Automotive market:  
For hose bundle systems

#### Restrictions

Not permitted for use in air brake systems  
Not suitable for high dynamic pulsation systems  
Not recommended for fuels (petrol, diesel etc.)  
Not recommended for mineral based hydraulic and lubricating oils

#### Construction

- Tube: Synthetic rubber  
Reinforcement: High-tensile fibre braid  
Cover: High performance polyurethane material in different colours

Temperature Range ..... -40 °C up to +100 °C

- Exception: Air ..... max. +70 °C  
Water ..... max. +85 °C



- High level of hose flexibility
- High abrasion resistance
- High torsion resistance
- Free from wetting disturbing substances
- Low push-in forces

#### Recommended Fluids

Air, dry air, water, water-oil-emulsions and water-glycol-emulsions.  
Consult the chemical compatibility section on pages **Ab-22** to **Ab-30** for more detailed information.

#### Fitting Series



Part Number	Hose I.D.				Hose O.D.		Pressure Rating				Vaccum kilo Pascal *1	min. bend radius	weight
	DN	Inch	Size	mm	mm	max. working pressure		min. burst pressure					
						MPa	psi	MPa	psi				
837PU-4-xxx-RL	6	1/4	-4	6.3	12.7	1.6	235	6.4	940	95	30	0.11	
837PU-6-xxx-RL	10	3/8	-6	9.5	15.9	1.6	235	6.4	940	95	50	0.15	
837PU-8-xxx-RL	12	1/2	-8	12.7	19.8	1.6	235	6.4	940	95	70	0.26	
837PU-10-xxx-RL	16	5/8	-10	15.9	23.0	1.6	235	6.4	940	51	90	0.27	
837PU-12-xxx-RL	20	3/4	-12	19.1	26.2	1.6	235	6.4	940	51	110	0.33	
837PU-16-xxx-RL	25	1	-16	25.4	32.5	1.6	235	6.4	940	51	180	0.52	

\*1 = the vacuum values listed in the table are vacuum pressure values in kPa. For an absolute value subtract the table value from 101 kPa  
Note: when ordering, specify Push-Lok hose part number, followed by size, followed by colour. Example: 837PU-4-XXX-RL

- XXX = BLK = black  
BLU = blue  
RED = red  
GRN = green  
GRA = grey



Example: 837PU-4-GRN-RL (green)  
RL = only available on reels

# 838M

## Push-Lok

For non-conductive applications

### Primary Applications

Special Market: For special electrical requirements,  
e.g. cooling lines with de-ionized water

### Restrictions

Not permitted for use in air brake systems.  
Not suitable for high dynamic pulsation systems.  
Not recommended for fuels (petrol, diesel etc.)

### Construction

Tube: Polyurethane material  
Reinforcement: High-tensile fibre braid  
Cover: Orange coloured polyurethane material

Temperature Range ..... -40 °C up to +80 °C



- Non conductive hose
- High level of hose flexibility

### Recommended Fluids

Mineral based hydraulic and lubricating oils, coolant, antifreeze, water, water-oil emulsions.  
Consult the chemical compatibility section on pages **Ab-22** to **Ab-30** for more detailed information.









### Fitting Series





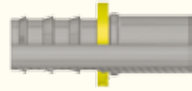
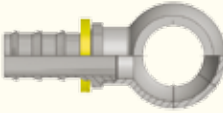

Part Number	Hose I.D.				Hose O.D. mm	Pressure Rating				Vacuum kilo Pascal *1 kPa	min. bend radius mm	weight kg
	DN	Inch	Size	mm		max. working pressure		min. burst pressure				
						MPa	psi	MPa	psi			
838M-4-RL	6	1/4	-4	6.3	11.2	1.6	232	6.4	928	10	30	0.08
838M-6-RL	10	3/8	-6	9.5	15.0	1.6	232	6.4	928	10	50	0.13
838M-8-RL	12	1/2	-8	12.7	19.1	1.6	232	6.4	928	10	70	0.20
838M-10-RL	16	5/8	-10	16.0	23.0	1.6	232	6.4	928	10	90	0.26
838M-12-RL	20	3/4	-12	19.0	26.0	1.6	232	6.4	928	10	110	0.31

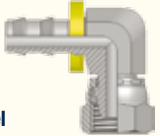
\*1 = the vacuum values listed in the table are vacuum pressure values in kPa. For an absolute value subtract the table value from 101 kPa  
RL = only available on reels



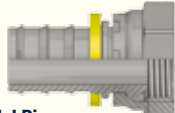

## DIN – Metric

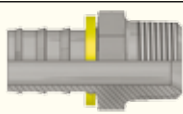
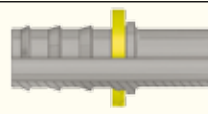
Page B1b-1 – B1b-8			
<p><b>CA</b> B1b-1</p>  <p>Female Metric 24° Light Series with O-Ring Swivel – Straight ISO 12151-2-SWS-L – DKOL</p>	<p><b>CE</b> B1b-1</p>  <p>Female Metric 24° Light Series with O-Ring Swivel – 45° Elbow ISO 12151-2-SWE 45°-L – DKOL 45°</p>	<p><b>CF</b> B1b-2</p>  <p>Female Metric 24° Light Series with O-Ring Swivel – 90° Elbow ISO 12151-2-SWE-L – DKOL 90°</p>	<p><b>D0</b> B1b-2</p>  <p>Male Metric 24° Light Series – Rigid Straight ISO 12151-2-S-L – CEL</p>
<p><b>C3</b> B1b-3</p>  <p>Female Metric Light Series – Swivel Straight (Ball Nose) DKL</p>	<p><b>C4</b> B1b-4</p>  <p>Female Metric Light Series – Swivel 45° Elbow (Ball Nose) DKL 45°</p>	<p><b>C5</b> B1b-5</p>  <p>Female Metric Light Series – Swivel 90° Elbow (Ball Nose) DKL 90°</p>	<p><b>1D</b> B1b-6</p>  <p>Metric Standpipe Light Series – Rigid Straight ISO 8434-1 – BEL</p>
<p><b>49</b> B1b-7</p>  <p>Metric Banjo Straight DIN 7642</p>	<p><b>9B</b> B1b-8</p>  <p>Female Metric Swivel Light Series 45° Elbow</p>	<p><b>9C</b> B1b-8</p>  <p>Female Metric Swivel Light Series 90° Elbow</p>	

## BSP

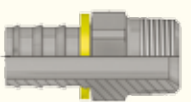
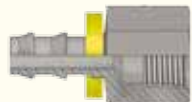
Page B1b-9 – B1b-11			
<p><b>92</b> B1b-9</p>  <p>Female BSP Parallel Pipe Swivel – Straight (60° Cone) BS5200-A – DKR</p>	<p><b>B1</b> B1b-9</p>  <p>Female BSP Parallel Pipe Swivel 45° Elbow (60° Cone) BS 5200-D – DKR 45°</p>	<p><b>B2</b> B1b-10</p>  <p>Female BSP Parallel Pipe Swivel 90° Elbow (60° Cone) BS 5200-B – DKR 90°</p>	<p><b>D9</b> B1b-10</p>  <p>Male BSP Parallel Pipe Rigid – Straight (60° Cone) BS5200 – AGR</p>
<p><b>91</b> B1b-11</p>  <p>Male BSP Taper Pipe – Rigid Straight BS5200 – AGR-K</p>	<p><b>34</b> B1b-11</p>  <p>Inch Standpipe (Brass)</p>		

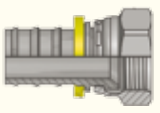
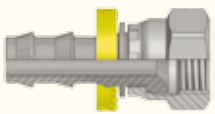
## SAE

Page B1b-12 – B1b-15			
<p><b>01</b> B1b-12</p>  <p>Male NPTF Pipe Rigid – Straight SAE J476A / J516 – AGN</p>	<p><b>02</b> B1b-12</p>  <p>Female NPTF Pipe – Rigid Straight SAE J476A / J516</p>	<p><b>03</b> B1b-13</p>  <p>Male JIC 37° – Rigid Straight ISO12151-5-S – AGJ</p>	<p><b>06/68</b> B1b-13</p>  <p>Female – JIC 37° SAE 45° Dual Flare Swivel – Straight ISO12151-5-SWS – DKJ</p>
<p><b>08</b> B1b-14</p>  <p>Female SAE 45° – Swivel Straight SAE J516</p>	<p><b>37/3V</b> B1b-15</p>  <p>Female JIC 37° SAE 45° – Dual Flare Swivel Female 45° Elbow ISO 12151-5-SWE 45° – DKJ 45°</p>	<p><b>39/3W</b> B1b-15</p>  <p>Female JIC 37° SAE 45° – Dual Flare Swivel Female 90° Elbow ISO 12151-5-SWES – DKJ 90°</p>	

# ORFS

Page B1b-16	
<p><b>JC</b> <b>B1b-16</b> Female ORFS Swivel – Straight Short ISO 12151-1 – SWSA SAE J516 – ORFS</p>	

# Others

Page B1b-17 – B1b-21			
<p><b>FF</b> <b>B1b-17</b></p> <p>Metru-Lok Swivel Female</p>	<p><b>AF</b> <b>B1b-17</b></p> <p>Male BSP Parallel Pipe Rigid – Straight (with O-ring Seal)</p>	<p><b>NM</b> <b>B1b-18</b></p> <p>Male BSP Parallel Pipe L Series – Rigid – Straight ED-Seal ISO 1179</p>	<p><b>VW121</b> <b>B1b-18</b></p> <p>BSP Swivel Female (VW-Norm 39-V-16631)</p>
<p><b>82</b> <b>B1b-19</b></p> <p>Push-Lok® Union</p>	<p><b>DP</b> <b>B1b-19</b></p> <p>Metric Swivel Female Tee Male Stud</p>	<p><b>DR</b> <b>B1b-20</b></p> <p>Metric Swivel Female Tee</p>	<p><b>5C</b> <b>B1b-20</b></p> <p>60° Cone Swivel Female</p>
<p><b>6C</b> <b>B1b-21</b></p> <p>60° Cone Swivel Female 45° Elbow</p>	<p><b>7C</b> <b>B1b-21</b></p> <p>60° Cone Swivel Female 90° Elbow</p>		



# CA

## Female Metric 24° Light Series with O-Ring Swivel – Straight

ISO 12151-2-SWS-L – DKOL

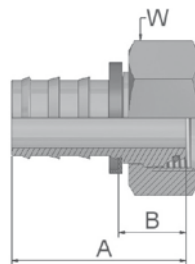

XXXXX-XX-XX Part Number 	Hose I.D.				Thread metric	Tube O.D. mm	A mm	B mm	W mm
	DN	Inch	Size	mm					
3CA82-6-4	6	1/4	-4	6.3	M12x1.5	6	40	21	14
3CA82-6-4B	6	1/4	-4	6.3	M12x1.5	6	40	21	14
3CA82-8-4	6	1/4	-4	6.3	M14x1.5	8	36	17	17
3CA82-8-4B	6	1/4	-4	6.3	M14x1.5	8	36	17	17
3CA82-10-4	6	1/4	-4	6.3	M16x1.5	10	36	17	19
3CA82-10-6	10	3/8	-6	9.5	M16x1.5	10	40	17	19
3CA82-10-6B	10	3/8	-6	9.5	M16x1.5	10	39	17	19
3CA82-12-6	10	3/8	-6	9.5	M18x1.5	12	40	17	22
3CA82-12-6B	10	3/8	-6	9.5	M18x1.5	12	39	17	22
3CA82-15-8	12	1/2	-8	12.7	M22x1.5	15	44	18	27
3CA82-15-8B	12	1/2	-8	12.7	M22x1.5	15	44	17	27
3CA82-15-10B	16	5/8	-10	15.9	M22x1.5	15	60	23	27
3CA82-18-10	16	5/8	-10	15.9	M26x1.5	18	56	19	32
3CA82-22-12	20	3/4	-12	19.1	M30x2	22	58	21	36
3CA82-22-12B	20	3/4	-12	19.1	M30x2	22	58	21	36

Fittings with standard O-ring seals can be used for temperatures from -30 °C up to +105 °C.

# CE

## Female Metric 24° Light Series with O-Ring Swivel – 45° Elbow

ISO 12151-2-SWE 45°-L – DKOL 45°

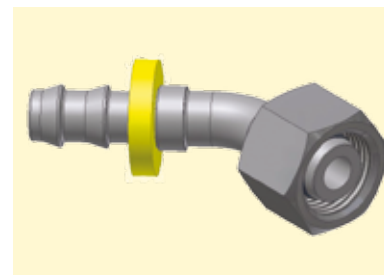
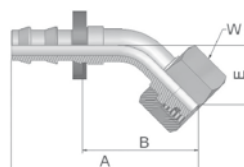

XXXXX-XX-XX Part Number 	Hose I.D.				Thread metric	Tube O.D. mm	A mm	B mm	E mm	W mm
	DN	Inch	Size	mm						
3CE82-6-4	6	1/4	-4	6.3	M12x1.5	6	56	37	21	14
3CE82-8-4	6	1/4	-4	6.3	M14x1.5	8	51	31	16	17
3CE82-10-6	10	3/8	-6	9.5	M16x1.5	10	59	37	19	19
3CE82-12-6	10	3/8	-6	9.5	M18x1.5	12	60	37	19	22
3CE82-15-8	12	1/2	-8	12.7	M22x1.5	15	69	43	21	27
3CE82-18-10	16	5/8	-10	15.9	M26x1.5	18	83	46	23	32
3CE82-22-12	20	3/4	-12	19.1	M30x2	22	97	60	26	36

Fittings with standard O-ring seals can be used for temperatures from -30 °C up to +105 °C.

Also available in stainless steel. Details can be found in CAT 4400.1/UK

Approved **fitting series** for hose types:

B: Brass; K: Without plastic ring; SM: Metric Hexagon

**82**  801 804 821FR 830M 831 836 837BM 837PU 838M

# CF Female Metric 24° Light Series with O-Ring Swivel – 90° Elbow

ISO 12151-2-SWE-L – DKOL 90°

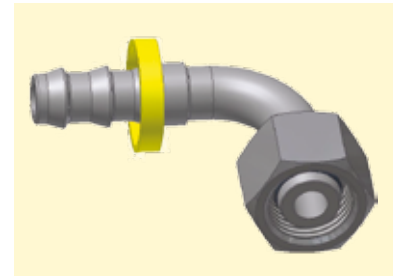
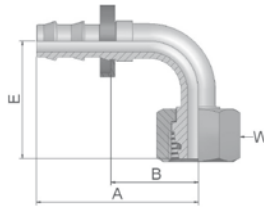



XXXXX-XX-XX Part Number 	Hose I.D.				Thread metric	Tube O.D. mm	A mm	B mm	E mm	W mm
	DN	Inch	Size	mm						
3CF82-6-4	6	1/4	-4	6.3	M12x1.5	6	42	23	36	14
3CF82-8-4	6	1/4	-4	6.3	M14x1.5	8	41	23	29	17
3CF82-10-4	6	1/4	-4	6.3	M16x1.5	10	42	23	31	19
3CF82-10-6	10	3/8	-6	9.5	M16x1.5	10	49	27	35	19
3CF82-10-6B	10	3/8	-6	9.5	M16x1.5	10	49	27	35	19
3CF82-12-6	10	3/8	-6	9.5	M18x1.5	12	49	27	35	22
3CF82-12-6B	10	3/8	-6	9.5	M18x1.5	12	49	27	35	22
3CF82-15-8	12	1/2	-8	12.7	M22x1.5	15	60	34	41	27
3CF82-15-8B	12	1/2	-8	12.7	M22x1.5	15	60	34	41	27
3CF82-18-10	16	5/8	-10	15.9	M26x1.5	18	74	37	45	32
3CF82-22-12	20	3/4	-12	19.1	M30x2	22	83	46	55	36

Fittings with standard O-ring seals can be used for temperatures from -30 °C up to +105 °C.  
Special O-rings are available on request.

# DO Male Metric 24° Light Series – Rigid Straight

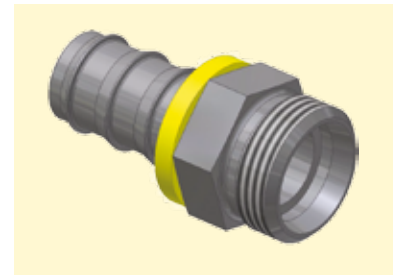
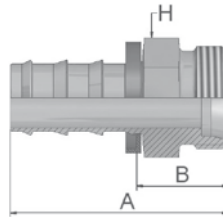
ISO 12151-2-S-L – CEL



XXXXX-XX-XX Part Number 	Hose I.D.				Thread metric	Tube O.D. mm	A mm	B mm	H mm
	DN	Inch	Size	mm					
3D082-6-4	6	1/4	-4	6.3	M12x1.5	6	35	16	12
3D082-8-4	6	1/4	-4	6.3	M14x1.5	8	36	17	14
3D082-8-4B	6	1/4	-4	6.3	M14x1.5	8	36	17	14
3D082-10-6	10	3/8	-6	9.5	M16x1.5	10	41	18	17
3D082-10-6B	10	3/8	-6	9.5	M16x1.5	10	41	18	17
3D082-12-6	10	3/8	-6	9.5	M18x1.5	12	41	18	19
3D082-12-6B	10	3/8	-6	9.5	M18x1.5	12	41	18	19
3D082-15-8	12	1/2	-8	12.7	M22x1.5	15	49	23	22
3D082-15-8B	12	1/2	-8	12.7	M22x1.5	15	49	22	22
3D082-18-8	12	1/2	-8	12.7	M26x1.5	18	48	21	27
3D082-18-10	16	5/8	-10	15.9	M26x1.5	18	58	21	27
3D082-18-10B	16	5/8	-10	15.9	M26x1.5	18	58	21	27
3D082-22-12	20	3/4	-12	19.1	M30x2	22	63	27	30
3D082-22-12B	20	3/4	-12	19.1	M30x2	22	63	27	30

Also available in stainless steel. Details can be found in CAT 4400.1/UK

Approved fitting series for hose types:

B: Brass; K: Without plastic ring; SM: Metric Hexagon





 801 804 821FR 830M 831 836 837BM 837PU 838M

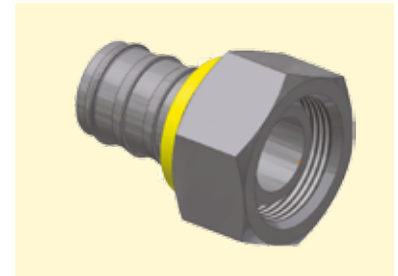
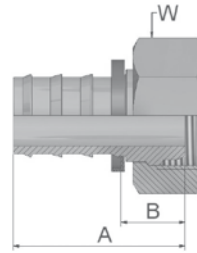

# C3 Female Metric Light Series – Swivel Straight (Ball Nose)

DKL



XXXXX-XX-XX Part Number 	 Hose I.D.				 Thread metric	Tube O.D. mm	A mm	B mm	 W mm
	DN	Inch	Size	mm					
3C382-6-4	6	1/4	-4	6.3	M12x1.5	6	33	14	14
3C382-6-4B	6	1/4	-4	6.3	M12x1.5	6	33	14	14
3C382-8-4	6	1/4	-4	6.3	M14x1.5	8	33	14	17
3C382-8-4B	6	1/4	-4	6.3	M14x1.5	8	36	17	19
3C382-10-4	6	1/4	-4	6.3	M16x1.5	10	34	15	19
3C382-10-6	10	3/8	-6	9.5	M16x1.5	10	37	15	19
3C382-10-6B	10	3/8	-6	9.5	M16x1.5	10	40	17	19
3C382-12-6	10	3/8	-6	9.5	M18x1.5	12	38	16	22
3C382-12-6B	10	3/8	-6	9.5	M18x1.5	12	40	17	22
3C382-15-8	12	1/2	-8	12.7	M22x1.5	15	42	15	27
3C382-15-8B	12	1/2	-8	12.7	M22x1.5	15	46	19	27
3C382-15-10	16	5/8	-10	15.9	M22x1.5	15	56	19	27
3C382-18-10	16	5/8	-10	15.9	M26x1.5	18	53	17	32
3C382-18-10B	16	5/8	-10	15.9	M26x1.5	18	58	22	32
3C382-22-12	20	3/4	-12	19.1	M30x2	22	53	17	36
3C382-22-12B	20	3/4	-12	19.1	M30x2	22	58	22	36
3C382-28-16	25	1	-16	25.4	M36x2	28	58	22	41
3C382-28-16B	25	1	-16	25.4	M36x2	28	58	22	41

Also available in stainless steel. Details can be found in CAT 4400.1/UK

Approved **fitting series** for hose types:





B: Brass; K: Without plastic ring; SM: Metric Hexagon

**82**  801 804 821FR 830M 831 836 837BM 837PU 838M

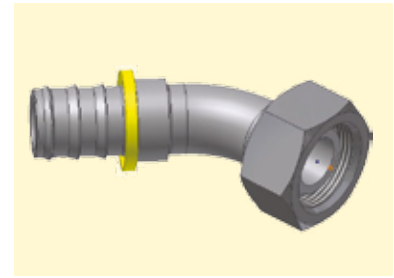
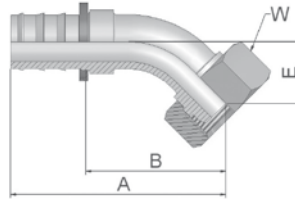
# C4 Female Metric Light Series – Swivel 45° Elbow (Ball Nose)

DKL 45°



XXXXX-XX-XX Part Number 	 Hose I.D.				 Thread metric	Tube O.D. mm	A mm	B mm	E mm	 W mm
	DN	Inch	Size	mm						
3C482-6-4	6	1/4	-4	6.3	M12x1.5	6	51	32	16	14
3C482-6-4B	6	1/4	-4	6.3	M12x1.5	6	51	32	16	14
3C482-8-4	6	1/4	-4	6.3	M14x1.5	8	51	32	16	17
3C482-8-4B	6	1/4	-4	6.3	M14x1.5	8	51	32	16	17
3C482-10-6	10	3/8	-6	9.5	M16x1.5	10	58	35	18	19
3C482-10-6B	10	3/8	-6	9.5	M16x1.5	10	58	35	17	19
3C482-12-6	10	3/8	-6	9.5	M18x1.5	12	59	36	18	22
3C482-12-6B	10	3/8	-6	9.5	M18x1.5	12	58	36	18	22
3C482-15-8	12	1/2	-8	12.7	M22x1.5	15	68	41	19	27
3C482-15-8B	12	1/2	-8	12.7	M22x1.5	15	67	41	19	27
3C482-15-10	16	5/8	-10	15.9	M22x1.5	15	82	45	21	27
3C482-15-10B	16	5/8	-10	15.9	M22x1.5	15	82	45	21	27
3C482-18-10	16	5/8	-10	15.9	M26x1.5	18	81	45	21	32
3C482-18-10B	16	5/8	-10	15.9	M26x1.5	18	81	45	21	32
3C482-18-12	20	3/4	-12	19.1	M26x1.5	18	96	60	26	32
3C482-22-12	20	3/4	-12	19.1	M30x2	22	88	52	23	36

Also available in stainless steel. Details can be found in CAT 4400.1/UK

Approved **fitting series** for hose types:

**B:** Brass; **K:** Without plastic ring; **SM:** Metric Hexagon

**82**  801 804 821FR 830M 831 836 837BM 837PU 838M

# C5 Female Metric Light Series – Swivel 90° Elbow (Ball Nose)

DKL 90°

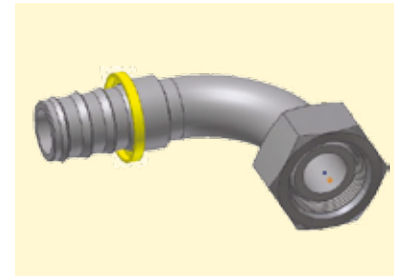
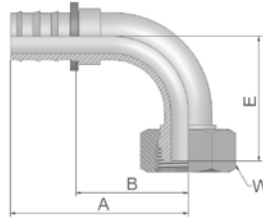

XXXXX-XX-XX Part Number 	Hose I.D.				Thread metric	Tube O.D. mm	A mm	B mm	E mm	W mm
	DN	Inch	Size	mm						
3C582-6-4	6	1/4	-4	6.3	M12x1.5	6	42	23	29	14
3C582-8-4	6	1/4	-4	6.3	M14x1.5	8	42	23	29	17
3C582-8-4B	6	1/4	-4	6.3	M14x1.5	8	41	23	29	17
3C582-10-6	10	3/8	-6	9.5	M16x1.5	10	49	27	33	19
3C582-12-6	10	3/8	-6	9.5	M18x1.5	12	49	27	34	22
3C582-12-6B	10	3/8	-6	9.5	M18x1.5	12	49	27	34	22
3C582-15-8	12	1/2	-8	12.7	M22x1.5	15	60	34	39	27
3C582-15-8B	12	1/2	-8	12.7	M22x1.5	15	58	32	39	27
3C582-18-10	16	5/8	-10	15.9	M26x1.5	18	74	37	43	32
3C582-18-10B	16	5/8	-10	15.9	M26x1.5	18	74	37	43	32
3C582-22-12	20	3/4	-12	19.1	M30x2	22	88	51	50	36
3C582-22-12B	20	3/4	-12	19.1	M30x2	22	88	52	50	36
3C582-28-16B	25	1	-16	25.4	M36x2	28	101	64	66	41

Also available in stainless steel. Details can be found in CAT 4400.1/UK

Approved **fitting series** for hose types:



B: Brass; K: Without plastic ring; SM: Metric Hexagon

**82**  801 804 821FR 830M 831 836 837BM 837PU 838M

# 1D Metric Standpipe Light Series – Rigid Straight

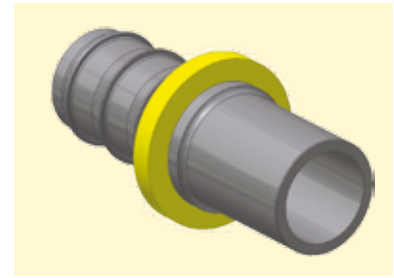
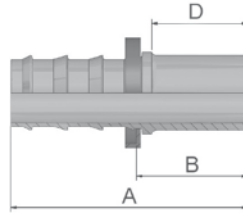
ISO 8434-1 – BEL



XXXXX-XX-XX Part Number 	 Hose I.D.				Tube O.D. mm	A mm	B mm	D mm
	DN	Inch	Size	mm				
31D82-6-4	6	1/4	-4	6.3	6	44	25	22
31D82-6-4B	6	1/4	-4	6.3	6	44	25	22
31D82-8-4	6	1/4	-4	6.3	8	44	25	22
31D82-8-4B	6	1/4	-4	6.3	8	44	25	22
31D82-10-6	10	3/8	-6	9.5	10	49	26	23
31D82-10-6B	10	3/8	-6	9.5	10	49	26	23
31D82-12-6	10	3/8	-6	9.5	12	49	27	23
31D82-12-6B	10	3/8	-6	9.5	12	49	27	23
31D82-15-8	12	1/2	-8	12.7	15	55	29	25
31D82-15-8B	12	1/2	-8	12.7	15	55	29	25
31D82-18-10	16	5/8	-10	15.9	18	67	30	26
31D82-18-10B	16	5/8	-10	15.9	18	67	30	26
31D82-22-12	20	3/4	-12	19.1	22	69	32	28
31D82-22-12B	20	3/4	-12	19.1	22	69	32	28

Attention: For assembly of EO-2-functional nut or nut and progressive ring use the EO-pre-assembly body.

Also available in stainless steel. Details can be found in CAT 4400.1/UK

Approved **fitting series** for hose types:

**B:** Brass; **K:** Without plastic ring; **SM:** Metric Hexagon



 801 804 821FR 830M 831 836 837BM 837PU 838M

49

**Metric Banjo  
Straight**

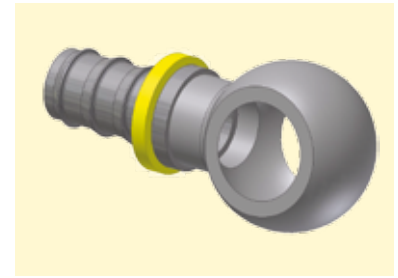
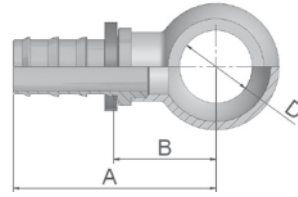
DIN 7642



XXXXX-XX-XX Part Number 	 Hose I.D.				A mm	B mm	D mm
	DN	Inch	Size	mm			
34982-8-4	6	1/4	-4	6.3	36	17	8
34982-10-4	6	1/4	-4	6.3	38	19	10
34982-12-4	6	1/4	-4	6.3	40	21	12
34982-14-4	6	1/4	-4	6.3	42	23	14
34982-10-6	10	3/8	-6	9.5	42	19	10
34982-12-6	10	3/8	-6	9.5	44	21	12
34982-14-6	10	3/8	-6	9.5	47	24	14
34982-16-6	10	3/8	-6	9.5	49	26	16
34982-17-6	10	3/8	-6	9.5	49	26	17
34982-14-8	12	1/2	-8	12.7	51	25	14
34982-18-8	12	1/2	-8	12.7	55	28	18
34982-22-8	12	1/2	-8	12.7	57	31	22
34982-22-10	16	5/8	-10	15.9	68	32	22
34982-26-12	20	3/4	-12	19.1	74	38	26

Also available in stainless steel. Details can be found in CAT 4400.1/UK

Approved **fitting series** for hose types:

B: Brass; K: Without plastic ring; SM: Metric Hexagon

 801 804 821FR 830M 831 836 837BM 837PU 838M

## 9B Female Metric Swivel Light Series 45° Elbow

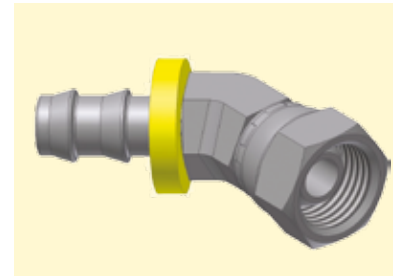
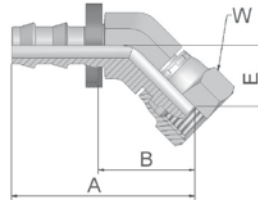

XXXXX-XX-XX Part Number 	Hose I.D.				Thread metric	Tube O.D. mm	A mm	B mm	E mm	W mm
	DN	Inch	Size	mm						
39B82-6-4BK	6	1/4	-4	6.3	M12x1.5	6	44	23	16	14
39B82-8-4BK	6	1/4	-4	6.3	M14x1.5	8	43	23	15	19
39B82-10-6BK	10	3/8	-6	9.5	M16x1.5	10	48	25	16	19
39B82-12-6BK	10	3/8	-6	9.5	M18x1.5	12	50	26	17	22
39B82-15-8BK	12	1/2	-8	12.7	M22x1.5	15	54	26	18	27

## 9C Female Metric Swivel Light Series 90° Elbow

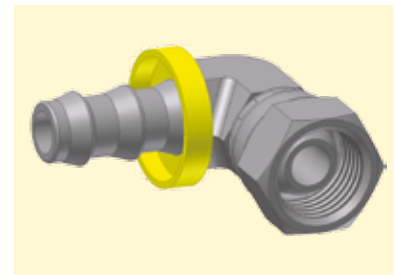
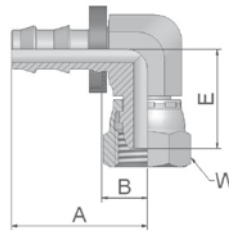

XXXXX-XX-XX Part Number 	Hose I.D.				Thread metric	Tube O.D. mm	A mm	B mm	E mm	W mm
	DN	Inch	Size	mm						
39C82-6-4BK	6	1/4	-4	6.3	M12x1.5	6	30	10	22	14
39C82-8-4BK	6	1/4	-4	6.3	M14x1.5	8	30	10	22	19
39C82-10-6BK	10	3/8	-6	9.5	M16x1.5	10	34	10	25	19
39C82-12-6BK	10	3/8	-6	9.5	M18x1.5	12	34	10	25	22
39C82-15-8BK	12	1/2	-8	12.7	M22x1.5	15	43	15	32	27

Also available in stainless steel. Details can be found in CAT 4400.1/UK

Approved **fitting series** for hose types:

**B:** Brass; **K:** Without plastic ring; **SM:** Metric Hexagon

 801 804 821FR 830M 831 836 837BM 837PU 838M

## 92 Female BSP Parallel Pipe Swivel – Straight (60° Cone)

BS5200-A – DKR

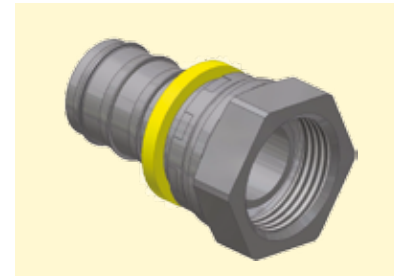
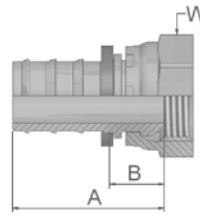

XXXXX-XX-XX Part Number 	Hose I.D.				Thread BSP	A mm	B mm	W mm
	DN	Inch	Size	mm				
39282-4-4	6	1/4	-4	6.3	1/4x19	33	14	17
39282-6-4B	6	1/4	-4	6.3	3/8x19	37	18	22
39282-6-6	10	3/8	-6	9.5	3/8x19	37	14	19
39282-8-8	12	1/2	-8	12.7	1/2x14	42	15	27
39282-8-8B	12	1/2	-8	12.7	1/2x14	46	19	27
39282-10-10	16	5/8	-10	15.9	5/8x14	53	16	30
39282-10-10B	16	5/8	-10	15.9	5/8x14	55	18	30
39282-12-12	20	3/4	-12	19.1	3/4x14	58	21	32
39282-12-12B	20	3/4	-12	19.1	3/4x14	58	21	32
39282-16-16B	25	1	-16	25.4	1x11	74	38	36

## B1 Female BSP Parallel Pipe Swivel 45° Elbow (60° Cone)

BS 5200-D – DKR 45°

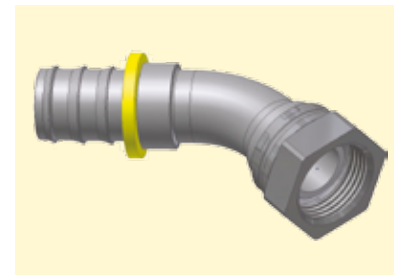
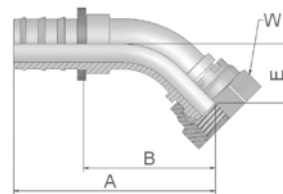

XXXXX-XX-XX Part Number 	Hose I.D.				Thread BSP	A mm	B mm	E mm	W mm
	DN	Inch	Size	mm					
3B182-4-4	6	1/4	-4	6.3	1/4x19	51	32	16	17
3B182-6-6	10	3/8	-6	9.5	3/8x19	58	35	18	19
3B182-6-6B	10	3/8	-6	9.5	3/8x19	58	45	17	19
3B182-8-8	12	1/2	-8	12.7	1/2x14	68	41	19	27
3B182-8-8B	12	1/2	-8	12.7	1/2x14	67	41	19	27
3B182-10-10	16	5/8	-10	15.9	5/8x14	81	45	21	30
3B182-12-12	20	3/4	-12	19.1	3/4x14	92	55	27	32

Also available in stainless steel. Details can be found in CAT 4400.1/UK

Approved **fitting series** for hose types:

B: Brass; K: Without plastic ring; SM: Metric Hexagon

 801 804 821FR 830M 831 836 837BM 837PU 838M

## B2 Female BSP Parallel Pipe Swivel 90° Elbow (60° Cone)

BS 5200-B – DKR 90°

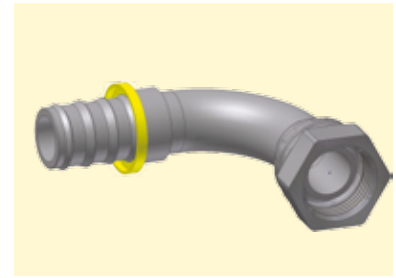
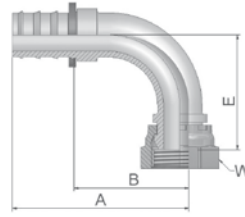

XXXXX-XX-XX Part Number 	Hose I.D.				Thread BSP	A mm	B mm	E mm	W mm
	DN	Inch	Size	mm					
3B282-4-4	6	1/4	-4	6.3	1/4x19	42	23	29	17
3B282-6-6	10	3/8	-6	9.5	3/8x19	49	27	33	19
3B282-6-6B	10	3/8	-6	9.5	3/8x19	49	27	33	19
3B282-8-8	12	1/2	-8	12.7	1/2x14	60	34	39	27
3B282-8-8B	12	1/2	-8	12.7	1/2x14	60	34	39	27
3B282-10-8	12	1/2	-8	12.7	5/8x14	58	32	40	30
3B282-10-10	16	5/8	-10	15.9	5/8x14	74	37	43	30
3B282-10-10B	16	5/8	-10	15.9	5/8x14	74	37	44	30
3B282-12-12	20	3/4	-12	19.1	3/4x14	83	46	53	32
3B282-12-12B	20	3/4	-12	19.1	3/4x14	83	46	53	32

## D9 Male BSP Parallel Pipe Rigid – Straight (60° Cone)

BS5200 – AGR

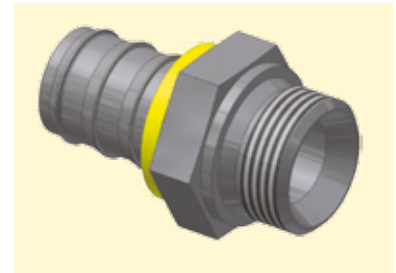
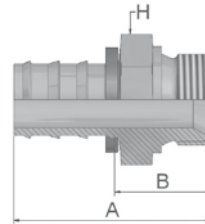

XXXXX-XX-XX Part Number 	Hose I.D.				Thread BSP	A mm	B mm	H mm
	DN	Inch	Size	mm				
3D982-2-4	6	1/4	-4	6.3	1/8x28	36	17	14
3D982-4-4	6	1/4	-4	6.3	1/4x19	41	23	19
3D982-4-4B	6	1/4	-4	6.3	1/4x19	41	23	19
3D982-4-6	10	3/8	-6	9.5	1/4x19	44	21	19
3D982-6-6	10	3/8	-6	9.5	3/8x19	45	23	22
3D982-6-6B	10	3/8	-6	9.5	3/8x19	45	23	22
3D982-8-8	12	1/2	-8	12.7	1/2x14	53	27	27
3D982-8-8B	12	1/2	-8	12.7	1/2x14	53	27	27
3D982-10-10	16	5/8	-10	15.9	5/8x14	65	28	30
3D982-10-10B	16	5/8	-10	15.9	5/8x14	65	28	30
3D982-12-12	20	3/4	-12	19.1	3/4x14	65	28	32
3D982-12-12B	20	3/4	-12	19.1	3/4x14	65	28	32

Also available in stainless steel. Details can be found in CAT 4400.1/UK

Approved **fitting series** for hose types:

B: Brass; K: Without plastic ring; SM: Metric Hexagon

 801 804 821FR 830M 831 836 837BM 837PU 838M



# 91 Male BSP Taper Pipe – Rigid Straight

BS5200 – AGR-K

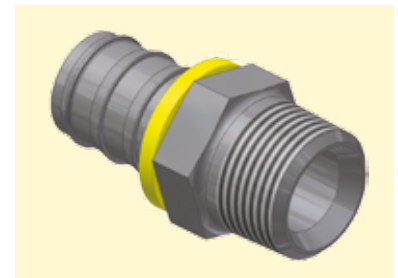
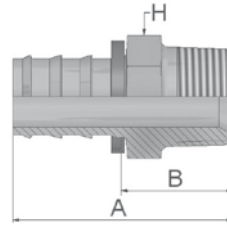

XXXXX-XX-XX Part Number 	Hose I.D.				Thread BSP	A mm	B mm	H mm
	DN	Inch	Size	mm				
39182-2-4B	6	1/4	-4	6.3	1/8x28	37	18	12
39182-4-4B	6	1/4	-4	6.3	1/4x19	40	21	14
39182-4-6B	10	3/8	-6	9.5	1/4x19	44	21	14
39182-6-6B	10	3/8	-6	9.5	3/8x19	45	22	19
39182-6-8B	12	1/2	-8	12.7	3/8x19	49	22	19
39182-8-8B	12	1/2	-8	12.7	1/2x14	55	29	22
39182-8-10B	16	5/8	-10	15.9	1/2x14	65	28	22
39182-12-10B	16	5/8	-10	15.9	3/4x14	69	32	30
39182-12-12B	20	3/4	-12	19.1	3/4x14	69	32	30

# 34 Inch Standpipe (Brass)

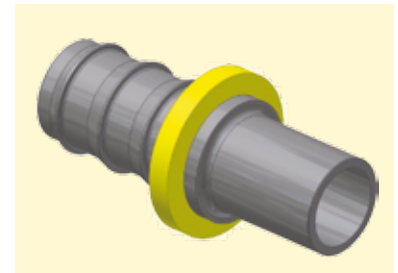
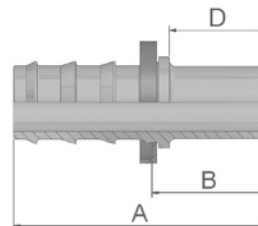

XXXXX-XX-XX Part Number 	Hose I.D.				Tube O.D.	A mm	B mm	D mm
	DN	Inch	Size	mm				
33482-4-4B	6	1/4	-4	6.3	1/4	48	29	26
33482-6-6B	10	3/8	-6	9.5	3/8	57	34	31
33482-8-8B	12	1/2	-8	12.7	1/2	55	28	25
33482-10-10B	16	5/8	-10	15.9	5/8	67	30	25
33482-12-12B	20	3/4	-12	19.1	3/4	67	30	25

Also available in stainless steel. Details can be found in CAT 4400.1/UK

Approved **fitting series** for hose types:





B: Brass; K: Without plastic ring; SM: Metric Hexagon

 801 804 821FR 830M 831 836 837BM 837PU 838M

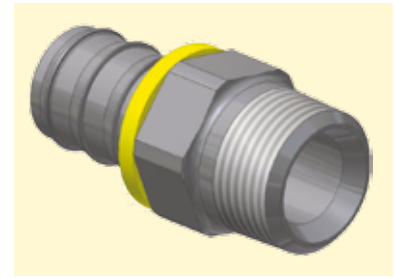
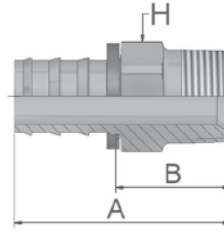
# 01 Male NPTF Pipe Rigid – Straight

SAE J476A / J516 – AGN

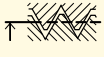



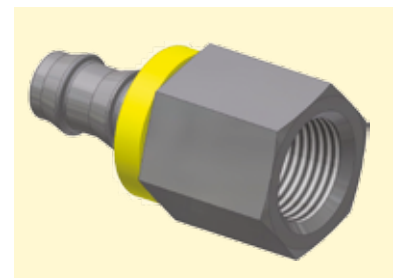
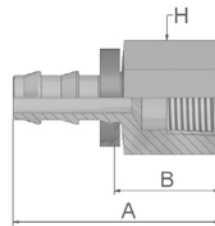

XXXXX-XX-XX Part Number 	 Hose I.D.				 Thread NPTF	A	B	 H
	DN	Inch	Size	mm		mm	mm	mm Inch
30182-2-4-SM	6	1/4	-4	6.3	1/8x27	35	16	12
30182-2-4B	6	1/4	-4	6.3	1/8x27	35	16	7/16
30182-4-4-SM	6	1/4	-4	6.3	1/4x18	40	21	14
30182-4-4B	6	1/4	-4	6.3	1/4x18	40	21	9/16
30182-6-4	6	1/4	-4	6.3	3/8x18	42	22	11/16
30182-6-4B	6	1/4	-4	6.3	3/8x18	42	22	11/16
30182-4-6-SM	10	3/8	-6	9.5	1/4x18	45	23	14
30182-4-6B	10	3/8	-6	9.5	1/4x18	45	22	9/16
30182-6-6-SM	10	3/8	-6	9.5	3/8x18	45	23	19
30182-8-6-SM	10	3/8	-6	9.5	1/2x14	52	29	22
30182-8-6B-SM	10	3/8	-6	9.5	1/2x14	52	29	22
30182-6-8B	12	1/2	-8	12.7	3/8x18	49	22	11/16
30182-8-8B-SM	12	1/2	-8	12.7	1/2x14	55	29	22
30182-8-10-SM	16	5/8	-10	15.9	1/2x14	66	29	22
30182-8-10B	16	5/8	-10	15.9	1/2x14	66	29	7/8
30182-12-10	16	5/8	-10	15.9	3/4x14	66	29	1-1/16
30182-8-12-SM	20	3/4	-12	19.1	1/2x14	66	29	22
30182-8-12B	20	3/4	-12	19.1	1/2x14	66	29	7/8
30182-12-12	20	3/4	-12	19.1	3/4x14	66	29	1-1/16
30182-12-12B	20	3/4	-12	19.1	3/4x14	66	29	1-1/16

# 02 Female NPTF Pipe – Rigid Straight

SAE J476A / J516

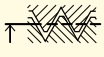

XXXXX-XX-XX Part Number 	 Hose I.D.				 Thread NPTF	A	B	 H
	DN	Inch	Size	mm		mm	mm	Inch
30282-4-4B	6	1/4	-4	6.3	1/4x18	40	21	3/4
30282-6-6B	10	3/8	-6	9.5	3/8x18	46	23	7/8
30282-8-8B	12	1/2	-8	12.7	1/2x14	55	28	1-1/16

Also available in stainless steel. Details can be found in CAT 4400.1/UK

Approved **fitting series** for hose types:

**B:** Brass; **K:** Without plastic ring; **SM:** Metric Hexagon

 801 804 821FR 830M 831 836 837BM 837PU 838M

# 03 Male JIC 37° – Rigid Straight

ISO12151-5-S – AGJ

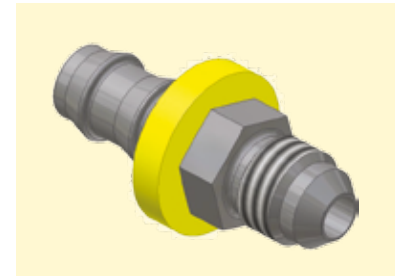
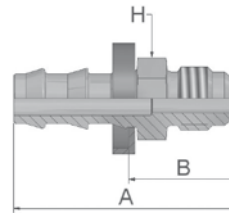

XXXXX-XX-XX Part Number 	Hose I.D.				Thread UNF	A mm	B mm	H Inch
	DN	Inch	Size	mm				
30382-4-4	6	1/4	-4	6.3	7/16x20	40	21	1/2
30382-6-6	10	3/8	-6	9.5	9/16x18	45	22	5/8
30382-6-6B	10	3/8	-6	9.5	9/16x18	45	22	5/8
30382-8-8	12	1/2	-8	12.7	3/4x16	52	26	3/4
30382-8-8B	12	1/2	-8	12.7	3/4x16	52	26	3/4
30382-12-12	20	3/4	-12	19.1	1-1/16x12	69	32	1-1/8
30382-12-12B	20	3/4	-12	19.1	1-1/16x12	69	32	1-1/8

# 06/68 Female – JIC 37° SAE 45° Dual Flare Swivel – Straight

ISO12151-5-SWS – DKJ

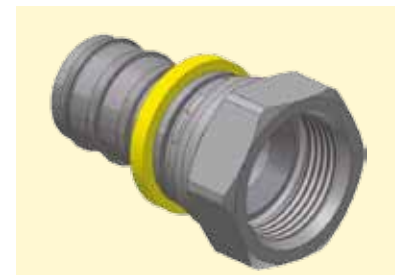
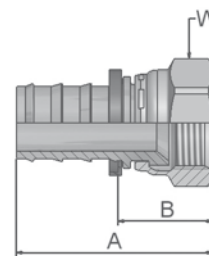

XXXXX-XX-XX Part Number 	Hose I.D.				Thread UNF	A mm	B mm	W mm Inch
	DN	Inch	Size	mm				
30682-4-4-SM	6	1/4	-4	6.3	7/16x20	40	21	14
30682-4-4B	6	1/4	-4	6.3	7/16x20	39	19	9/16
30682-5-4B	6	1/4	-4	6.3	1/2x20	40	21	5/8
30682-6-4B	6	1/4	-4	6.3	9/16x18	42	22	11/16
30682-5-6B	10	3/8	-6	9.5	1/2x20	44	21	5/8
30682-6-6	10	3/8	-6	9.5	9/16x18	46	22	11/16
30682-6-6-SM	10	3/8	-6	9.5	9/16x18	45	22	19
30682-6-6B-SM	10	3/8	-6	9.5	9/16x18	45	22	19
30682-8-6B	10	3/8	-6	9.5	3/4x16	47	24	7/8
36882-8-6-SM	10	3/8	-6	9.5	3/4x16	48	25	22
30682-10-8B	12	1/2	-8	12.7	7/8x14	52	25	1
30682-10-10-SM	16	5/8	-10	15.9	7/8x14	65	28	27
30682-10-10B	16	5/8	-10	15.9	7/8x14	62	25	1
30682-12-12-SM	20	3/4	-12	19.1	1-1/16x12	67	30	32
30682-12-12B-SM	20	3/4	-12	19.1	1-1/16x12	67	31	32

Also available in stainless steel. Details can be found in CAT 4400.1/UK

Approved **fitting series** for hose types:





B: Brass; K: Without plastic ring; SM: Metric Hexagon

**82**  801 804 821FR 830M 831 836 837BM 837PU 838M

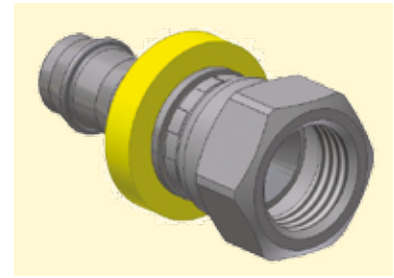
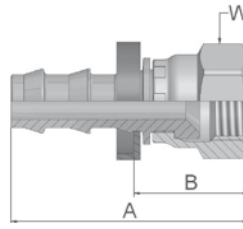
# 08 Female SAE 45° – Swivel Straight

SAE J516

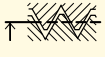

XXXXX-XX-XX Part Number 	 Hose I.D.				 Thread UNF	A	B	 W
	DN	Inch	Size	mm		mm	mm	Inch
30882-4-4	6	1/4	-4	6.3	7/16x20	39	19	9/16
30882-4-4B	6	1/4	-4	6.3	7/16x20	39	19	9/16
30882-5-4B	6	1/4	-4	6.3	1/2x20	40	21	5/8
30882-6-6B	10	3/8	-6	9.5	5/8x18	46	23	3/4
30882-8-8	12	1/2	-8	12.7	3/4x16	51	25	7/8
30882-8-8B	12	1/2	-8	12.7	3/4x16	51	25	7/8
30882-10-10	16	5/8	-10	15.9	7/8x14	65	28	1
30882-10-10B	16	5/8	-10	15.9	7/8x14	65	28	1
30882-12-12	20	3/4	-12	19.1	1-1/16x14	67	30	1-1/4
30882-12-12B	20	3/4	-12	19.1	1-1/16x14	67	30	1-1/4

Also available in stainless steel. Details can be found in CAT 4400.1/UK

Approved **fitting series** for hose types:

**B:** Brass; **K:** Without plastic ring; **SM:** Metric Hexagon

 801 804 821FR 830M 831 836 837BM 837PU 838M

### 37/3V Female JIC 37° SAE 45° – Dual Flare Swivel Female 45° Elbow

ISO 12151-5-SWE 45° – DKJ 45°

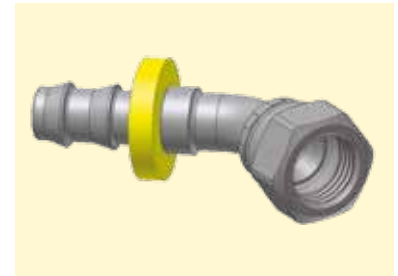
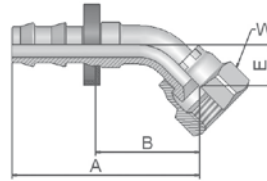

XXXXX-XX-XX Part Number 	Hose I.D.				Thread UNF	A mm	B mm	E mm	W mm Inch
	DN	Inch	Size	mm					
33782-4-4	6	1/4	-4	6.3	7/16x20	39	20	8	9/16
33V82-4-4B-SM	6	1/4	-4	6.3	7/16x20	44	25	10	17
33782-6-6-SM	10	3/8	-6	9.5	9/16x18	51	28	11	19
33782-8-8	12	1/2	-8	12.7	3/4x16	54	35	14	7/8

### 39/3W Female JIC 37° SAE 45° – Dual Flare Swivel Female 90° Elbow

ISO 12151-5-SWES – DKJ 90°

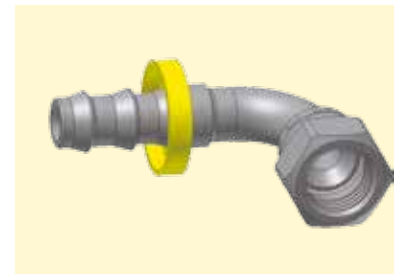
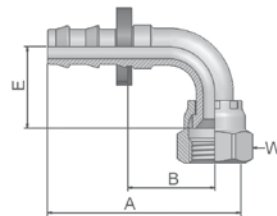

XXXXX-XX-XX Part Number 	Hose I.D.				Thread UNF	A mm	B mm	E mm	W mm Inch
	DN	Inch	Size	mm					
33982-4-4	6	1/4	-4	6.3	7/16x20	39	20	17	5/8
33982-6-6	10	3/8	-6	9.5	9/16x18	50	28	22	11/16
33982-6-6-SM	10	3/8	-6	9.5	9/16x18	47	25	23	19
33982-8-8	12	1/2	-8	12.7	3/4x16	59	33	28	7/8
33W82-8-8-SM	12	1/2	-8	12.7	3/4x16	55	29	28	22
33982-10-10	16	5/8	-10	15.9	7/8x14	74	37	31	1
33982-12-12	20	3/4	-12	19.1	1-1/16x12	84	46	46	1-1/4
33982-12-12-SM	20	3/4	-12	19.1	1-1/16x12	88	52	48	32

Also available in stainless steel. Details can be found in CAT 4400.1/UK

Approved **fitting series** for hose types:





B: Brass; K: Without plastic ring; SM: Metric Hexagon

**82**  801 804 821FR 830M 831 836 837BM 837PU 838M

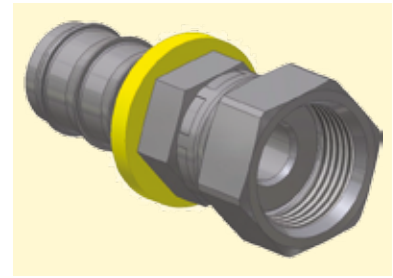
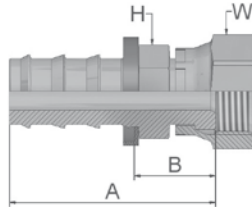
# JC Female ORFS Swivel – Straight Short

ISO 12151-1 – SWSA  
SAE J516 – ORFS

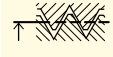

XXXXX-XX-XX Part Number 	 Hose I.D.				 Thread UNF	A	B	 H mm Inch	 W mm Inch
	DN	Inch	Size	mm		mm	mm		
3JC82-4-4	6	1/4	-4	6.3	9/16x18	36	17	9/16	11/16
3JC82-6-6	10	3/8	-6	9.5	11/16x16	40	18	11/16	13/16
3JC82-6-6-SM	10	3/8	-6	9.5	11/16x16	40	18	19	22
3JC82-8-6-SM	10	3/8	-6	9.5	13/16x16	43	21	22	24
3JC82-8-8-SM	12	1/2	-8	12.7	13/16x16	47	21	22	24
3JC82-8-10	16	5/8	-10	15.9	13/16x16	57	21	3/4	15/16
3JC82-10-10	16	5/8	-10	15.9	1x14	61	24	15/16	1-1/8
3JC82-10-12	20	3/4	-12	19.1	1x14	61	24	1	1-1/8
3JC82-12-12	20	3/4	-12	19.1	1-3/16x12	67	30	1-1/8	1-3/8

Also available in stainless steel. Details can be found in CAT 4400.1/UK

Approved **fitting series** for hose types:

**B:** Brass; **K:** Without plastic ring; **SM:** Metric Hexagon

 801 804 821FR 830M 831 836 837BM 837PU 838M

## FF Metru-Lok Swivel Female

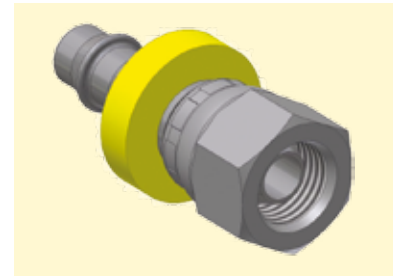
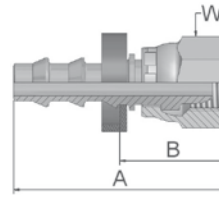

XXXXX-XX-XX Part Number 	Hose I.D.				Thread metric	Tube O.D. mm	A mm	B mm	W mm
	DN	Inch	Size	mm					
3FF82-6-4B	6	1/4	-4	6.3	M10x1	6	36	16	14
3FF82-8-4B	6	1/4	-4	6.3	M12x1	8	31	12	14
3FF82-10-6B	10	3/8	-6	9.5	M14x1	10	35	12	17
3FF82-12-6B	10	3/8	-6	9.5	M16x1	12	35	12	19
3FF82-14-8B	12	1/2	-8	12.7	M18x1	14	38	12	22
3FF82-16-8B	12	1/2	-8	12.7	M22x1.5	16	38	12	27
3FF82-18-10B	16	5/8	-10	15.9	M24x1.5	18	51	15	27
3FF82-22-12B	20	3/4	-12	19.1	M28x1.5	22	51	15	32

## AF Male BSP Parallel Pipe Rigid – Straight (with O-ring Seal)

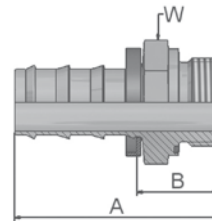

XXXXX-XX-XX Part Number 	Hose I.D.				Thread BSP	A mm	B mm	W mm
	DN	Inch	Size	mm				
3AF82-2-4B	6	1/4	-4	6.3	1/8x28	34	15	17
3AF82-4-4B	6	1/4	-4	6.3	1/4x19	39	20	19
3AF82-4-6B	10	3/8	-6	9.5	1/4x19	43	20	19
3AF82-6-6B	10	3/8	-6	9.5	3/8x19	46	23	22
3AF82-6-8B	12	1/2	-8	12.7	3/8x19	49	22	22
3AF82-8-8B	12	1/2	-8	12.7	1/2x14	53	26	27
3AF82-8-10B	16	5/8	-10	15.9	1/2x14	63	26	27

Also available in stainless steel. Details can be found in CAT 4400.1/UK

Approved **fitting series** for hose types:





B: Brass; K: Without plastic ring; SM: Metric Hexagon

 801 804 821FR 830M 831 836 837BM 837PU 838M

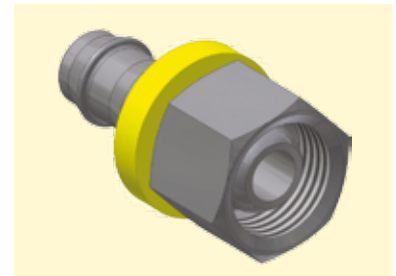
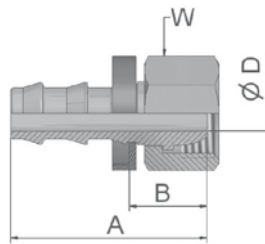
## VW121 BSP Swivel Female

(VW-Norm 39-V-16631)

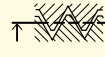

XXXXX-XX-XX Part Number 	 Hose I.D.				 Thread BSP	A	B	D	 W
	DN	Inch	Size	mm		mm	mm	mm	mm
VW121-8937*	6	1/4	-4	6.3	1/4x19	32	13	5	17
VW121-8938**	10	3/8	-6	9.5	3/8x19	38	15	7.5	19
VW121-8939**	14	1/2	-8	12.7	1/2x14	46	19	11	27
VW121-8940**	16	5/8	-10	15.9	3/4x14	58	21	14	32
VW121-8941*	20	3/4	-12	19.1	1x11	53	16	17	41

\*stainless steel nipple, steel nut  
\*\*brass nipple, brass nut

Also available in stainless steel. Details can be found in CAT 4400.1/UK

Approved **fitting series** for hose types:

**B:** Brass; **K:** Without plastic ring; **SM:** Metric Hexagon

**82**  801 804 821FR 830M 831 836 837BM 837PU 838M



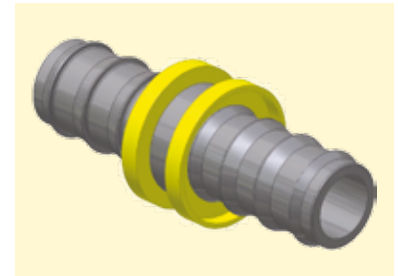
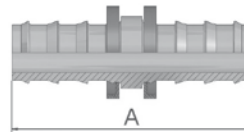

## 82 Push-Lok® Union

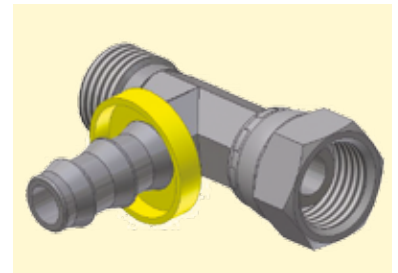
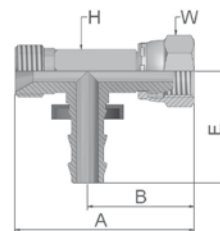

XXXXX-XX-XX Part Number 	Hose I.D.				A
	DN	Inch	Size	mm	mm
38282-4-4B	6	1/4	-4	6.3	45
38282-4-4	6	1/4	-4	6.3	45
38282-6-6B	10	3/8	-6	9.5	54
38282-8-8	12	1/2	-8	12.7	64
38282-8-8B	12	1/2	-8	12.7	64
38282-10-10	16	5/8	-10	15.9	84
38282-10-10B	16	5/8	-10	15.9	84
38282-12-12	20	3/4	-12	19.1	84
38282-12-12B	20	3/4	-12	19.1	84

## DP Metric Swivel Female Tee Male Stud



XXXXX-XX-XX Part Number 	Hose I.D.				Thread metric	A mm	B mm	E mm	H mm	W mm
	DN	Inch	Size	mm						
DP-6-6-4BK	6	1/4	-4	6.3	M12x1	43	24	30	11	14
DP-8-8-4BK	6	1/4	-4	6.3	M14x1.5	43	24	30	11	14
DP-10-10-6BK	10	3/8	-6	9.5	M16x1.5	48	26	34	13	19
DP-15-15-8BK	12	1/2	-8	12.7	M22x1.5	58	32	42	17	27

Standard nipples are stocked without plastic collar. If you need a collar, delete K from the part number.

Also available in stainless steel. Details can be found in CAT 4400.1/UK

Approved **fitting series** for hose types:

B: Brass; K: Without plastic ring; SM: Metric Hexagon

**82**  801 804 821FR 830M 831 836 837BM 837PU 838M

## DR Metric Swivel Female Tee

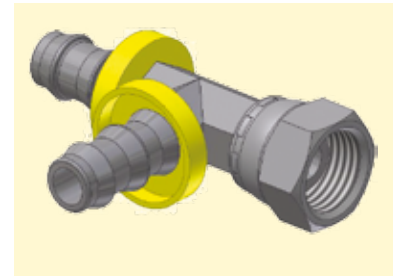
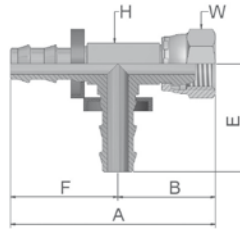

XXXXX-XX-XX Part Number 	Hose I.D.				Thread metric	A mm	B mm	E mm	F mm	H mm	W mm
	DN	Inch	Size	mm							
DR-6-4-4BK	6	1/4	-4	6.3	M12x1	54	24	30	30	11	14
DR-10-6-6BK	10	3/8	-6	9.5	M16x1.5	59	25	34	34	13	19
DR-15-8-8BK	12	1/2	-8	12.7	M22x1.5	74	32	42	42	17	27

## 5C 60° Cone Swivel Female

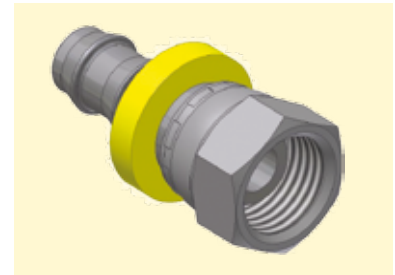
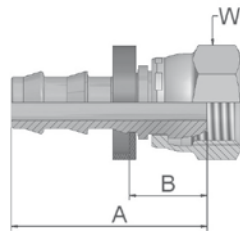

XXXXX-XX-XX Part Number 	Hose I.D.				Thread metric	A mm	B mm	W mm
	DN	Inch	Size	mm				
35C82-6-4B	6	1/4	-4	6.3	M12x1.5	33	14	14
35C82-6-4BK	6	1/4	-4	6.3	M12x1.5	33	14	14
35C82-10-6BK	10	3/8	-6	9.5	M16x1.5	38	15	19
35C82-10-6B	10	3/8	-6	9.5	M16x1.5	38	15	19
35C82-15-8B	12	1/2	-8	12.7	M22x1.5	44	18	27
35C82-15-8BK	12	1/2	-8	12.7	M22x1.5	44	18	27
35C82-18-10BK	16	5/8	-10	15.9	M26x1.5	56	18	32

Also available in stainless steel. Details can be found in CAT 4400.1/UK

Approved **fitting series** for hose types:

**B:** Brass; **K:** Without plastic ring; **SM:** Metric Hexagon

 801 804 821FR 830M 831 836 837BM 837PU 838M

## 6C 60° Cone Swivel Female 45° Elbow

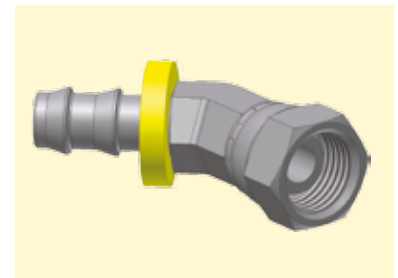
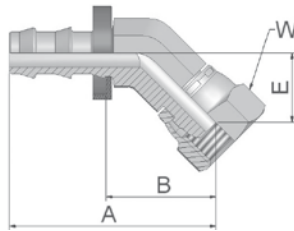

XXXXX-XX-XX Part Number 	Hose I.D.				Thread metric	A mm	B mm	E mm	W mm
	DN	Inch	Size	mm					
36C82-6-4BK	6	1/4	-4	6.3	M12x1.5	44	25	16	14
36C82-10-6BK	10	3/8	-6	9.5	M16x1.5	48	26	16	19
36C82-15-8BK	12	1/2	-8	12.7	M22x1.5	54	28	18	27

## 7C 60° Cone Swivel Female 90° Elbow

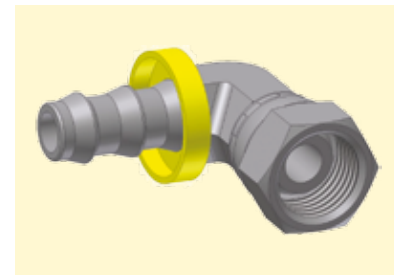
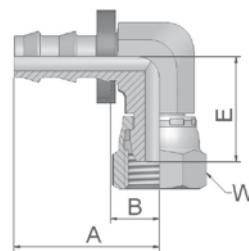

XXXXX-XX-XX Part Number 	Hose I.D.				Thread metric	A mm	B mm	E mm	W mm
	DN	Inch	Size	mm					
37C82-6-4BK	6	1/4	-4	6.3	M12x1.5	30	11	22	14
37C82-10-6BK	10	3/8	-6	9.5	M16x1.5	34	11	25	19
37C82-15-8BK	12	1/2	-8	12.7	M22x1.5	43	16	32	27

Also available in stainless steel. Details can be found in CAT 4400.1/UK

Approved **fitting series** for hose types:

B: Brass; K: Without plastic ring; SM: Metric Hexagon

 801 804 821FR 830M 831 836 837BM 837PU 838M



## Assembly Instructions

1. Cut the hose right angled with a sharp knife. If necessary it is possible to use a lubricant (water/soap solution with 5 % soap fluid and 95 % water) for easy assembly.
2. Insert fitting into hose until first barb is in hose. Place end of fitting against a flat object (bench, door, wall) and grip hose approximately 1" from end and push with a steady force until end of hose is covered by yellow plastic collar. Alternatively please use the Parker Assembly Tool No. 611050G or 611050HV.

### Attention!

During assembly, please keep in mind that Push-Lok fittings will provide an effective grip only when the Push-Lok hose is pushed fully on the insert, where the cropped end of the hose should be fully concealed by the plastic collar. **For easy assembly of hose 830M, 837BM and 837PU please use only Push-Lok Assembly Oil No. H896137.** Push-Lok Assembly Oil is free from wetting disturbing substances.

Don't use oil, lubricant or soap fluids for this hose!



## Disassembly Instructions

1. Cut lengthwise along a line at approximately a 20 angle from centre line of hose. The cut should be approximately 1" long. Be careful not to nick barbs when cutting the hose.
2. Grip hose and give a sharp down-ward tug to disengage from fitting.

### Attention!

Before re-use of the nipple please check nipple for damage. Damaged nipples can cause leakage.

## Assembly Tool

Tool designed for assembly of Push-Lok fittings and hose in all sizes. Toggle actions greatly reduce effort necessary to hold hose and press in fitting. Only a few pounds of force is needed on either handle to quickly assemble any size.

Light version  
Part No. 611050G

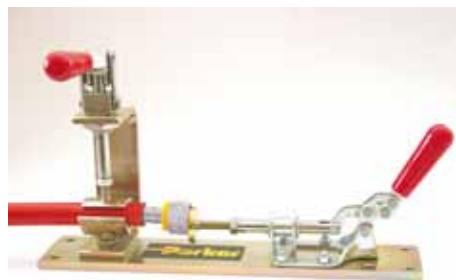

Heavy version  
Part No. 611050HV

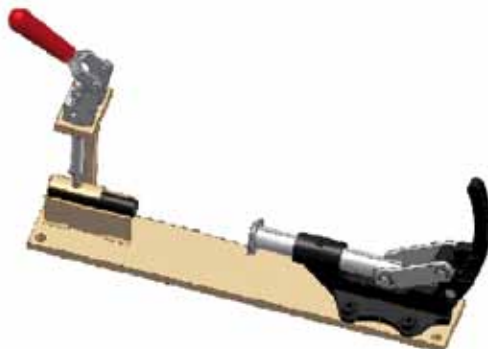

Push-Lok Assembly Oil  
1-litre bottle Part No. H896137





# Low-Pressure Transportation and Hydraulic Hose and Fittings

– the right solution for special applications and requirements



- A wide range of different hose types in rubber is available, with textile-braided or fire-retardant covers
- Proven, safe and easy self-assembly system
- Large bore sizes available
- High working temperatures
- One fitting series for all SAE 100 R5 and similar hoses



# Parkrimp® *No-Skive*

The system for fast and leak-free assemblies

- No skiving tool needed
- No need to remove the cover
- Crimps one-piece fittings
- Parkalign positions the fittings in the dies perfectly every time
- Quick and easy: no gauges to set on the machine
- Portable machines for field repair
- Meets EN safety regulations

## The perfect match



The complete system from one source. No-Skive hose, No-Skive fitting and crimping machine with world-wide guarantee and availability.

## Parker's colour-coded die sets



No loose parts to mismatch or misplace – die set segments linked together. Die sets provide 360° evenly applied crimping forces for an ideal crimp result.

## Parkalign®



Parker's exclusive Parkalign® positions the fitting in the dies perfectly every time.



## Applications

The definitive hose range for all special applications and requirements







# Transportation and Hydraulic Hoses and Fittings

Low pressure	Transportation + Hydraulic	No-Skive Hose	201	<i>No-Skive</i>	B2a-1
			206	<i>No-Skive</i>	B2a-2
			213	<i>No-Skive</i>	B2a-3
			221FR	<i>No-Skive</i>	B2a-4
			285	<i>No-Skive</i>	B2a-5
			293	<i>No-Skive</i>	B2a-6
			601	<i>No-Skive</i>	B2a-7
			611	<i>No-Skive</i>	B2a-8
			611HT	<i>No-Skive</i>	B2a-9
			681	<i>No-Skive</i>	B2a-10
			681DB	<i>No-Skive</i>	B2a-11
			Fittings 26 series		DIN - Metric
			BSP		B2b-3 – B2b-4
			SAE		B2b-5 – B2b-7
			ORFS		B2b-8
			Others		B2b-9 – B2b-11

## Standard

<p><b>601</b> B2a-7</p>  <p><i>No-Skive</i> SAE 100R3</p>	<p><b>611</b> B2a-8</p>  <p><i>No-Skive</i> DIN EN 854-R6</p>	<p><b>681</b> B2a-10</p>  <p><i>No-Skive 2TE</i> DIN EN 854-2TE</p>
--	--	---





## High temperature

<p><b>611HT</b> B2a-9</p>  <p><i>No-Skive</i> High-temperature textile hose</p>
--

## Railway

<p><b>681DB</b> B2a-11</p>  <p><i>No-Skive 2TE</i> DIN EN 854-2TE (with approvals for rail transportation)</p>
---

## Transportation

<p><b>201</b> B2a-1</p>  <p><i>No-Skive Airbrake</i> SAE 100R5 – SAE J1402AII</p>	<p><b>206</b> B2a-2</p>  <p><i>No-Skive Airbrake</i> SAE 100R5 – SAE J1402AII</p>	<p><b>213</b> B2a-3</p>  <p><i>No-Skive High Temperature</i> For engines and compressed air systems</p>	<p><b>293</b> B2a-6</p>  <p><i>No-Skive High Temperature</i> Engine and air brake/truck hose</p>
--	--	---	---

## Fire retardant

<p><b>221FR</b> B2a-4</p>  <p><i>No-Skive Fire Retardant</i> Marine fuel and engine hose</p>
---

## Refrigeration

<p><b>285</b> B2a-5</p>  <p><b>Air Conditioning and Refrigeration</b> SAE J2064 Type C, Class 1</p>
--

# 201

## No-Skive Airbrake

SAE 100R5 – SAE J1402AII

### Primary Applications

Transportation: Air brake hose

General: Low pressure applications

### Type Approvals

Details please find on pages **Ab-14** and **Ab-15**

### Applicable Specifications

SAE 100R5, SAE J1402AII, D. O. T. FMVSS 106-AII

### Construction

Tube: Synthetic rubber

Reinforcement: One fibre inner braid,  
one high-tensile steel wire braid

Cover: Rubber layer and textile braided cover

Temperature Range ..... -40 °C up to +150 °C

Exception: Air ..... max. +70 °C

Water ..... max. +85 °C



- Textile braided cover
- **No-Skive** hose construction
- 150 °C working temperature

### Recommended Fluids

Petroleum based hydraulic fluids, water-glycol and water-oil emulsion hydraulic fluids, grease, lubricants, crude and fuel oils, air and water.

Consult the chemical compatibility section on pages **Ab-22** to **Ab-30** for more detailed information.

### Fitting Series



Part Number	Hose I.D.				Hose O.D. mm	Pressure Rating				Vacuum kilo Pascal *1 kPa	min. bend radius mm	weight kg
	DN	Inch	Size	mm		max. working pressure		min. burst pressure				
						MPa	psi	MPa	psi			
201-4		3/16	-4	5.0	12.2	20.7	3000	83.0	12000	95	75	0.22
201-5		1/4	-5	6.3	14.8	20.7	3000	83.0	12000	95	85	0.27
201-6		5/16	-6	8.0	17.2	15.5	2250	62.0	9000	95	100	0.34
201-8		13/32	-8	10.0	19.5	13.8	2000	55.0	8000	95	120	0.40
201-10		1/2	-10	12.5	23.4	12.0	1750	48.0	7000	95	140	0.55
201-12		5/8	-12	16.0	27.4	10.3	1500	41.0	6000	95	165	0.68
201-16		7/8	-16	22.0	31.4	5.5	800	22.0	3200	67	185	0.68
201-20		1-1/8	-20	29.0	38.1	4.3	625	17.0	2500	67	230	0.76
201-24		1-3/8	-24	35.0	44.5	3.5	500	14.0	2000	51	265	1.01
201-32		1-13/16	-32	46.0	56.4	2.4	350	10.0	1400	37	335	1.32

\*1 = the vacuum values listed in the table are vacuum pressure values in kPa. For an absolute value subtract the table value from 101kPa.

The combination of high temperature and high pressure could reduce the hose life.

The maximum working pressures shown in the table are for service up to a maximum temperature of 100 °C.

For use at higher temperatures, consult the pressure/temperature curve in section A for the reduced maximum working pressure.

# 206

## No-Skive Airbrake

SAE 100R5 – SAE J1402All

### Primary Applications

Transportation: Air brake hose

General: Low pressure applications

### Type Approvals

Details please find on pages **Ab-14** and **Ab-15**

### Applicable Specifications

SAE 100R5, SAE J1402All, D. O. T. FMVSS 106-All

### Construction

Tube: Parker PKR-elastomer tube

Reinforcement: One fibre inner braid,  
one high-tensile steel wire braid

Cover: Rubber layer and  
blue textile braided cover

Temperature Range ..... -48 °C up to +150 °C

Exception: Air ..... max. +100 °C

Water ..... max. +85 °C



- Blue textile braided cover
- *No-Skive* hose construction
- For very low (-48 °C) working temperature

### Recommended Fluids

Petroleum based hydraulic fluids, water-glycol and water-oil emulsion hydraulic fluids, grease, lubricants, crude and fuel oils, air and water.

Consult the chemical compatibility section on pages **Ab-22** to **Ab-30** for more detailed information.

### Fitting Series



Part Number	Hose I.D.				Hose O.D. mm	Pressure Rating				Vaccum kilo Pascal *1 kPa	min. bend radius mm	weight kg
	DN	Inch	Size	mm		max. working pressure		min. burst pressure				
						MPa	psi	MPa	psi			
206-4		3/16	-4	5.0	13.2	20.7	3000	83.0	12000	95	75	0.22
206-5		1/4	-5	6.3	14.8	20.7	3000	83.0	12000	95	85	0.27
206-6		5/16	-6	8.0	17.1	15.5	2250	62.0	9000	95	90	0.34
206-8		13/32	-8	10.0	19.5	13.8	2000	55.0	8000	95	90	0.40
206-10		1/2	-10	12.5	23.4	12.0	1750	48.0	7000	95	100	0.55
206-12		5/8	-12	16.0	27.4	10.3	1500	41.0	6000	95	100	0.68
206-16		7/8	-16	22.0	31.4	5.5	800	22.0	3200	67	100	0.68
206-20		1-1/8	-20	29.0	38.1	4.3	625	17.0	2500	67	140	0.76
206-24		1-3/8	-24	35.0	44.5	3.5	500	14.0	2000	51	190	1.01
206-32		1-13/16	-32	46.0	56.4	2.4	350	10.0	1400	37	335	1.32

\*1 = the vacuum values listed in the table are vacuum pressure values in kPa. For an absolute value subtract the table value from 101kPa.  
The combination of high temperature and high pressure could reduce the hose life.  
The maximum working pressures shown in the table are for service up to a maximum temperature of 100 °C.  
For use at higher temperatures, consult the pressure/temperature curve in section A for the reduced maximum working pressure.

# 213

## No-Skive High Temperature

For engines and compressed air systems



- *No-Skive* hose construction
- Ideal for high-temperature and small bend radii applications
- Compatible with a large range of fluids

### Primary Applications

Transportation: Air brake hose

Compressors: Compressed air hose

### Type Approvals

Details please find on pages **Ab-14** and **Ab-15**

### Applicable Specifications

SAE J1402AI, D.O.T. FMVSS 106-AI

### Construction

Tube: Parker PKR-elastomer tube

Reinforcement: One fibre inner braid,  
one high-tensile steel wire braid

Cover: Rubber layer and  
black textile braided cover  
include 2 green strips

### Recommended Fluids

Petroleum based hydraulic fluids, water-glycol and water-oil emulsion hydraulic fluids, grease, lubricants, crude and fuel oils, air and water.

Consult the chemical compatibility section on pages **Ab-22** to **Ab-30** for more detailed information.

Temperature Range ..... -45 °C up to +150 °C

Exception: Air ..... max. +100 °C

Water ..... max. +85 °C

### Fitting Series



Part Number	Hose I.D.				Hose O.D. mm	Pressure Rating				min. bend radius mm	weight kg
	DN	Inch	Size	mm		max. working pressure		min. burst pressure			
						MPa	psi	MPa	psi		
213-4		3/16	-4	5.0	12.5	13.8	2000	55.0	8000	20	0.18
213-5		1/4	-5	6.3	14.1	10.3	1500	41.0	6000	25	0.21
213-6		5/16	-6	8.0	15.7	10.3	1500	41.0	6000	30	0.25
213-8		13/32	-8	10.0	18.7	8.6	1250	34.0	5000	45	0.30
213-10		1/2	-10	12.5	21.1	6.9	1000	28.0	4000	55	0.33
213-12		5/8	-12	16.0	24.3	5.2	750	21.0	3000	70	0.36
213-16		7/8	-16	22.0	30.6	2.8	400	11.0	1600	90	0.45
213-20		1-1/8	-20	29.0	37.8	2.1	300	8.0	1200	115	0.65
213-24		1-3/8	-24	35.0	44.0	1.7	300	8.0	1200	190	0.73
213-32		1-13/16	-32	46.0	54.5	1.4	200	5.5	800	355	1.00

The combination of high temperature and high pressure could reduce the hose life.

The maximum working pressures shown in the table are for service up to a maximum temperature of 100 °C.

For use at higher temperatures, consult the pressure/temperature curve in section A for the reduced maximum working pressure.

# 221FR

## No-Skive Fire Retardant

Marine fuel and engine hose

### Primary Applications

Marine: Marine fuel hose  
General: Where fire retardance is an issue

### Type Approvals

Details please find on pages **Ab-14** and **Ab-15**

### Applicable Specifications

SAE J1527 R3, USCG Type AI, SAE J1942, ISO 7840

### Construction

Tube: Fuel and oil-resistant rubber  
Reinforcement: One high-tensile steel wire braid  
Cover: Flame retardant special fibre outer cover

Temperature Range ..... -20 °C up to +100 °C

Exception: Air ..... max. +70 °C  
Water ..... max. +85 °C



- Fire retardant hose cover
- *No-Skive* hose construction
- Marine approvals

### Recommended Fluids

Petroleum based hydraulic fluids, water-glycol and water-oil emulsion hydraulic fluids, grease, lubricants, crude, fuel oils and water.

Consult the chemical compatibility section on pages **Ab-22** to **Ab-30** for more detailed information.

### Fitting Series



Part Number	Hose I.D.				Hose O.D. mm	Pressure Rating				Vacuum kilo Pascal *1 kPa	min. bend radius mm	weight kg
	DN	Inch	Size	mm		max. working pressure		min. burst pressure				
						MPa	psi	MPa	psi			
221FR-5		1/4	-5	6.3	15	3.5	500	14.0	2000	81	25	0.28
221FR-6		5/16	-6	8.0	17	3.5	500	14.0	2000	81	30	0.34
221FR-8		13/32	-8	10.0	20	3.5	500	14.0	2000	81	45	0.42
221FR-10		1/2	-10	12.5	23	3.5	500	14.0	2000	68	55	0.58
221FR-12		5/8	-12	16.0	27	3.5	500	14.0	2000	68	70	0.61
221FR-16		7/8	-16	22.0	31	3.5	500	14.0	2000	68	90	0.70

\*1 = the vacuum values listed in the table are vacuum pressure values in kPa. For an absolute value subtract the table value from 101kPa. The combination of high temperature and high pressure could reduce the hose life.

# 285

## Air Conditioning and Refrigeration

SAE J2064 Type C, Class 1



- *No-Skive* hose construction
- Usable for main refrigerant fluids
- Compatible with modern refrigerants

### Primary Applications

Air Conditioning: For industrial and mobile applications

### Applicable Specifications

SAE J2064 Type C, Class 1

### Construction

Tube: Nylon barrier between two elastomeric layers  
 Reinforcement: One textile braid  
 Cover: Heat, moisture and ozone resistant rubber

### Recommended Fluids

For use with Freon refrigerants 12, 134a and 22. Consult the chemical compatibility section on pages **Ab-22** to **Ab-30** for more detailed information.

Temperature Range ..... -30 °C up to +125 °C

### Fitting Series



Part Number	Hose I.D.				Hose O.D. mm	Pressure Rating				Vacuum kilo Pascal *1 kPa	min. bend radius mm	weight kg
	DN	Inch	Size	mm		max. working pressure		min. burst pressure				
						MPa	psi	MPa	psi			
285-4-RL		3/16	-4	5.0	12.4	3.4	500	17.2	2500	95	25	0.14
285-6-RL		5/16	-6	8.0	15.7	3.4	500	17.2	2500	95	38	0.19
285-8-RL		13/32	-8	10.0	18.8	3.4	500	17.2	2500	95	51	0.25
285-10-RL		1/2	-10	12.5	21.1	3.4	500	17.2	2500	95	64	0.27
285-12-RL		5/8	-12	16.0	24.4	3.4	500	17.2	2500	95	76	0.34

\*1 = the vacuum values listed in the table are vacuum pressure values in kPa. For an absolute value subtract the table value from 101kPa.  
 For size -16 a hose 285-16 is available on request.  
 RL = only available on reels.

# 293

## No-Skive High Temperature

Engine and air brake/truck hose

### Primary Applications

Truck Market: Air brake hose  
Engine cooling circuit

### Type Approvals

Details please find on pages **Ab-14** and **Ab-15**

### Applicable Specifications

SAE J1402AI, D.O.T. FMVSS 106

### Construction

Tube: Synthetic PKR rubber  
Reinforcement: One fibre braid  
Cover: Black nylon braid

Temperature Range ..... -50 °C up to +150 °C

Exception: Air ..... max. +100 °C

Water ..... max. +85 °C



- High temperature  
– high flex hose performance
- **No-Skive** hose construction
- Wide temperature range

### Recommended Fluids

Petroleum-based hydraulic fluids and lubrication oils, diesel fuels and antifreeze solutions; water-, water-oil- and water-glycol emulsion hydraulic fluids.

Consult the chemical compatibility section on pages **Ab-22** to **Ab-30** for more detailed information.

### Fitting Series



Part Number	Hose I.D.				Hose O.D. mm	Pressure Rating				min. bend radius mm	weight kg
	DN	Inch	Size	mm		max. working pressure		min. burst pressure			
						MPa	psi	MPa	psi		
293-4-RL		3/16	-4	5.0	12.5	3.5	500	13.8	2000	15	0.15
293-6-RL		5/16	-6	8.0	15.7	3.5	500	13.8	2000	25	0.22
293-8-RL		13/16	-8	10.0	18.7	3.5	500	13.8	2000	40	0.27
293-10-RL		1/2	-10	12.5	21.1	3.1	450	12.4	1800	50	0.30
293-12-RL		5/8	-12	16.0	24.3	3.1	450	12.4	1800	65	0.33
293-16-RL		7/8	-16	22.0	30.6	3.1	450	12.4	1800	80	0.37

The combination of high temperature and high pressure could reduce the hose life.  
RL = only available on reels.



# 601

*No-Skive*

SAE 100R3



- Textile braided reinforcement
- *No-Skive* hose construction
- Small bend radii
- Up to +125 °C working temperature

## Primary Applications

General Market: Low pressure hydraulic applications

## Applicable Specifications

SAE 100R3, DIN EN 854-R3

## Construction

Tube: Synthetic rubber  
 Reinforcement: Two fibre braids  
 Cover: MSHA accepted synthetic rubber

Temperature Range ..... -40 °C up to +125 °C

Exception: Air ..... max. +70 °C  
 Water ..... max. +85 °C

## Recommended Fluids

Petroleum based hydraulic fluids, water-glycol and water-oil emulsion hydraulic fluids, grease, lubricants, crude and fuel oils, air and water.

Consult the chemical compatibility section on pages **Ab-22** to **Ab-30** for more detailed information.

## Fitting Series

- Available as complete hose assembly
- Parker 43 series fittings are compatible with this hose and are available only upon request.

Part Number	Hose I.D.				Hose O.D. mm	Pressure Rating				min. bend radius mm	weight kg
	DN	Inch	Size	mm		max. working pressure		min. burst pressure			
						MPa	psi	MPa	psi		
601-4	6	1/4	-4	6.3	14.0	8.6	1250	35.0	5000	75	0.19
601-6	10	3/8	-6	9.5	19.0	7.8	1125	31.0	4500	100	0.33
601-8	12	1/2	-8	12.7	23.0	6.9	1000	28.0	4000	130	0.42
601-12	20	3/4	-12	19.1	32.0	5.2	750	21.0	3000	150	0.64
601-16	25	1	-16	25.4	38.0	3.9	565	16.0	2250	200	0.91

The combination of high temperature and high pressure could reduce the hose life.

# 611

*No-Skive*

DIN EN 854-R6



- One textile braid
- According to DIN EN 854-R6
- *No-Skive* hose construction for 2-piece fittings

## Primary Applications

General Market: Low pressure hydraulic applications

## Applicable Specifications

DIN EN 854-R6

## Construction

Tube: Synthetic rubber  
Reinforcement: One fibre braid  
Cover: Synthetic rubber

Temperature Range ..... -40 °C up to +100 °C

Exception: Air ..... max. +70 °C  
Water ..... max. +85 °C

## Recommended Fluids

Petroleum based hydraulic fluids, water-glycol and water-oil emulsion hydraulic fluids, grease, lubricants, crude and fuel oils, air and water.

Consult the chemical compatibility section on pages **Ab-22** to **Ab-30** for more detailed information.

## Fitting Series

- Available as complete hose assembly
- Compatible with 2-piece fittings for use with adjustable crimpers only (47 series nipple and 10064 series shell)

Part Number	Hose I.D.				Hose O.D. mm	Pressure Rating				min. bend radius mm	weight kg
	DN	Inch	Size	mm		max. working pressure		min. burst pressure			
						MPa	psi	MPa	psi		
611-4	6	1/4	-4	6.3	12.8	2.8	400	11.2	1600	65	0.13
611-6	10	3/8	-6	9.5	16.0	2.8	400	11.2	1600	75	0.16
611-8	12	1/2	-8	12.7	20.0	2.8	400	11.2	1600	100	0.27
611-10	16	5/8	-10	15.9	23.2	2.4	350	9.6	1400	125	0.28
611-12	20	3/4	-12	19.0	26.2	2.1	300	8.4	1200	150	0.36

The combination of high temperature and high pressure could reduce the hose life.

# 611HT

*No-Skive*

High-temperature textile hose

## Primary Applications

General Market: Low pressure hydraulic applications/  
high temperature applications

Engine Applications:

Diesel fuel lines, engine cooling circuits

## Type Approvals

Details please find on pages **Ab-14** and **Ab-15**

## Applicable Specifications

DIN EN 854-R6

## Construction

Tube: Synthetic PKR rubber

Reinforcement: One fibre braid

Cover: MSHA accepted synthetic rubber

Temperature Range ..... -40 °C up to +150 °C

Exception: Air ..... max. +100 °C

Water ..... max. +85 °C



- For high demand applications, such as diesel fuel lines, water cooling or high-temp lines up to +150 °C
- MSHA - accepted synthetic rubber cover
- According to DIN EN 854-R6
- *No-Skive* hose construction for 2-piece fittings

## Recommended Fluids

Petroleum-based hydraulic fluids and lubrication oils, diesel fuels and antifreeze solutions; water-glycol and water-oil emulsion, air and water.

Consult the chemical compatibility section on pages **Ab-22** to **Ab-30** for more detailed information.

## Fitting Series

- Available as complete hose assembly
- Compatible with 2-piece fittings for use with adjustable crimpers only (47 series nipple and 10064 series shell)

Part Number	Hose I.D.				Hose O.D. mm	Pressure Rating				min. bend radius mm	weight kg
	DN	Inch	Size	mm		max. working pressure		min. burst pressure			
						MPa	psi	MPa	psi		
611HT-4	6	1/4	-4	6.3	12.8	2.8	400	11.2	1600	65	0.13
611HT-6	10	3/8	-6	9.5	16.0	2.8	400	11.2	1600	75	0.16
611HT-8	12	1/2	-8	12.7	20.0	2.8	400	11.2	1600	100	0.27
611HT-10	16	5/8	-10	15.9	23.2	2.4	350	9.6	1400	125	0.28
611HT-12	20	3/4	-12	19.0	26.2	2.1	300	8.4	1200	150	0.36

The combination of high temperature and high pressure could reduce the hose life.

# 681

## No-Skive 2TE

DIN EN 854-2TE



- Two layers of fabric braid
- *No-Skive* hose construction
- Small bend radii

### Primary Applications

General Market: Low pressure hydraulic application

### Applicable Specifications

DIN EN 854-2TE

### Construction

Tube: Synthetic rubber  
Reinforcement: Two fibre braids  
Cover: Synthetic rubber

Temperature Range ..... -40 °C up to +100 °C

Exception: Air ..... max. +70 °C

Water ..... max. +85 °C

### Recommended Fluids

Petroleum based hydraulic fluids, water-glycol and water-oil emulsion hydraulic fluids, grease, lubricants, crude and fuel oils, air and water.

Consult the chemical compatibility section on pages **Ab-22** to **Ab-30** for more detailed information.

### Fitting Series

- Available as complete hose assembly
- Compatible with 2-piece fittings for use with adjustable crimpers only (47 series nipple and 10064 series shell)

Part Number	Hose I.D.				Hose O.D. mm	Pressure Rating				min. bend radius mm	weight kg
	DN	Inch	Size	mm		max. working pressure		min. burst pressure			
						MPa	psi	MPa	psi		
681-4	6	1/4	-4	6.3	13.1	7.5	1090	30.0	4360	40	0.15
681-5	8	5/16	-5	7.9	14.6	6.8	980	27.0	3920	50	0.16
681-6	10	3/8	-6	9.5	16.2	6.3	910	25.0	3640	60	0.19
681-8	12	1/2	-8	12.7	19.9	5.8	840	23.0	3360	70	0.24
681-10	16	5/8	-10	15.9	23.4	5.0	725	20.0	2900	90	0.35
681-12	20	3/4	-12	19.1	26.5	4.5	650	18.0	2600	110	0.39
681-16	25	1	-16	25.4	33.4	4.0	580	16.0	2320	150	0.59

The combination of high temperature and high pressure could reduce the hose life.

## 681DB

### No-Skive 2TE

DIN EN 854-2TE

(with approvals for rail transportation)

#### Primary Applications

General Market: Low pressure hydraulic application

Rail Transportation Market:

Hydraulic applications around  
train vehicles

#### Type Approvals

Details please find on pages **Ab-14** and **Ab-15**

#### Applicable Specifications

DIN EN 854-2TE

#### Construction

Tube: Synthetic rubber

Reinforcement: Two fibre braids

Cover: Flame retardant synthetic rubber

Temperature Range ..... -40 °C up to +100 °C

Exception: Air ..... max. +70 °C

Water ..... max. +85 °C



- Two layers of fabric braid
- **No-Skive** hose construction
- Small bend radii
- Flame retardant rubber cover
- Railway approved as follows:
  - German Standard: **DIN 5510-2**
  - French Standard: **NF F16-101/102 I2/F3**
  - British Standard: **BS 6853 - Table 4**

#### Recommended Fluids

Petroleum based hydraulic fluids, water-glycol and water-oil emulsion hydraulic fluids, grease, lubricants, crude and fuel oils, air and water.

Consult the chemical compatibility section on pages **Ab-22** to **Ab-30** for more detailed information.



#### Fitting Series

- Available as complete hose assembly
- Compatible with 2-piece fittings for use with adjustable crimpers only (47 series nipple and 10064 series shell)

Part Number	Hose I.D.				Hose O.D. mm	Pressure Rating				min. bend radius mm	weight kg
	DN	Inch	Size	mm		max. working pressure		min. burst pressure			
						MPa	psi	MPa	psi		
681DB-4	6	1/4	-4	6.3	13.1	7.5	1090	30.0	4360	40	0.15
681DB-5	8	5/16	-5	7.9	14.6	6.8	980	27.0	3920	50	0.16
681DB-6	10	3/8	-6	9.5	16.2	6.3	910	25.0	3640	60	0.19
681DB-8	12	1/2	-8	12.7	19.9	5.8	840	23.0	3360	70	0.24
681DB-10	16	5/8	-10	15.9	23.4	5.0	725	20.0	2900	90	0.35
681DB-12	20	3/4	-12	19.1	26.5	4.5	650	18.0	2600	110	0.39
681DB-16	25	1	-16	25.4	33.4	4.0	580	16.0	2320	150	0.59

The combination of high temperature and high pressure could reduce the hose life.

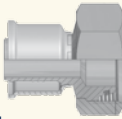

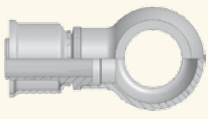
## DIN – Metric

Page B2b-1 – B2b-2			
<p><b>CA</b> B2b-1</p>  <p>Female Metric 24° Light Series with O-Ring Swivel – Straight ISO 12151-2-SWS-L – DKOL</p>	<p><b>CE</b> B2b-1</p>  <p>Female Metric 24° Light Series with O-Ring Swivel – 45° Elbow ISO 12151-2-SWE 45°-L – DKOL 45°</p>	<p><b>CF</b> B2b-2</p>  <p>Female Metric 24° Light Series with O-Ring Swivel – 90° Elbow ISO 12151-2-SWE-L – DKOL 90°</p>	<p><b>49</b> B2b-2</p>  <p>Metric Banjo Straight DIN 7642</p>

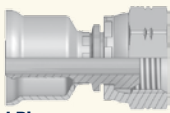
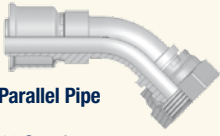
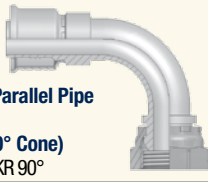
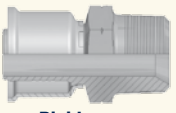
## BSP

Page B2b-3 – B2b-4			
<p><b>92</b> B2b-3</p>  <p>Female BSP Parallel Pipe Swivel – Straight (60° Cone) BS5200-A – DKR</p>	<p><b>B1</b> B2b-3</p>  <p>Female BSP Parallel Pipe Swivel 45° Elbow (60° Cone) BS 5200-D – DKR 45°</p>	<p><b>B2</b> B2b-4</p>  <p>Female BSP Parallel Pipe Swivel 90° Elbow (60° Cone) BS 5200-B – DKR 90°</p>	<p><b>91</b> B2b-4</p>  <p>Male BSP Taper Pipe – Rigid Straight BS5200 – AGR-K</p>

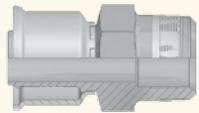
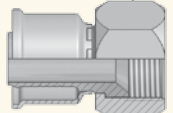
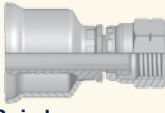
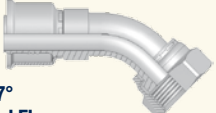

## SAE

Page B2b-5 – B2b-7			
<p><b>01</b> B2b-5</p>  <p>Male NPTF Pipe Rigid – Straight SAE J476A / J516 – AGN</p>	<p><b>06/68</b> B2b-5</p>  <p>Female – JIC 37° SAE 45° Dual Flare Swivel – Straight ISO12151-5-SWS – DKJ</p>	<p><b>08</b> B2b-6</p>  <p>Female SAE 45° – Swivel Straight SAE J516</p>	<p><b>37/3V</b> B2b-6</p>  <p>Female JIC 37° SAE 45° – Dual Flare Swivel Female 45° Elbow ISO 12151-5-SWE 45° – DKJ 45°</p>
<p><b>39/3W</b> B2b-7</p>  <p>Female JIC 37° SAE 45° – Dual Flare Swivel Female 90° Elbow ISO 12151-5-SWES – DKJ 90°</p>			

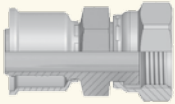
# ORFS

Page B2b-8	
<p><b>JC</b>  <b>B2b-8</b>                      Female ORFS                      Swivel – Straight                      Short                      ISO 12151-1 – SWSA                      SAE J516 – ORFS</p>	

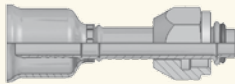
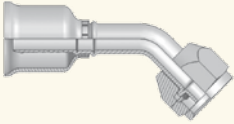
# Others

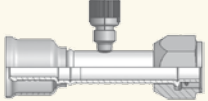
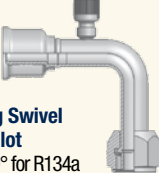
Page B2b-9 – B2b-11			
<p><b>5S</b>  <b>B2b-9</b></p>  <p>Female Tube O-ring Swivel                      Short Pilot</p>	<p><b>5H</b>  <b>B2b-9</b></p>  <p>Female Tube O-Ring Swivel                      45° Elbow – Short Pilot</p>	<p><b>5T</b>  <b>B2b-10</b></p>  <p>Female Tube O-Ring Swivel                      90° Elbow – Short Pilot</p>	<p><b>59PT</b>  <b>B2b-10</b></p>  <p>Male Tube O-Ring Swivel                      Long Pilot                      With Charge Port at 180° for R134a</p>
<p><b>5LPT</b>  <b>B2b-11</b></p>  <p>Female Tube O-Ring Swivel                      90° Elbow – Long Pilot                      With Charge Port at 180° for R134a</p>			





## CA Female Metric 24° Light Series with O-Ring Swivel – Straight

ISO 12151-2-SWS-L – DKOL

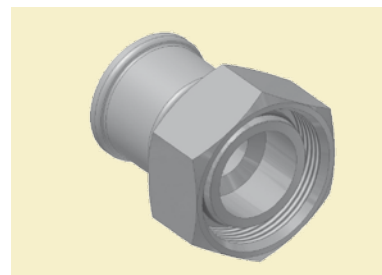
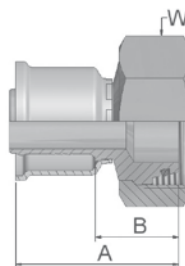

XXXXX-XX-XX Part Number 26	Hose I.D.			Thread metric	Tube O.D. mm	A mm	B mm	W mm
	Inch	Size	mm					
1CA26-6-4	3/16	-4	5.0	M12x1.5	6	40	20	14
1CA26-8-4	3/16	-4	5.0	M14x1.5	8	41	21	17
1CA26-10-5	1/4	-5	6.3	M16x1.5	10	41	20	19
1CA26-10-6	5/16	-6	8.0	M16x1.5	10	41	20	19
1CA26-12-6	5/16	-6	8.0	M18x1.5	12	41	21	22
1CA26-12-8	13/32	-8	10.0	M18x1.5	12	41	21	22
1CA26-15-8	13/32	-8	10.0	M22x1.5	15	42	21	27
1CA26-18-10	1/2	-10	12.5	M26x1.5	18	46	23	32
1CA26-18-12	5/8	-12	16.0	M26x1.5	18	46	23	32
1CA26-22-12	5/8	-12	16.0	M30x2	22	48	25	36
1CA26-28-16	7/8	-16	22.0	M36x2	28	54	28	41
1CA26-28-20	1-1/8	-20	29.0	M36x2	28	60	34	41
1CA26-35-20	1-1/8	-20	29.0	M45x2	35	56	29	50
1CA26-35-24	1-3/8	-24	35.0	M45x2	35	62	34	50
1CA26-42-24	1-3/8	-24	35.0	M52x2	42	59	31	60

Hose fittings are delivered with ozone resistant Nitrile (NBR) O-ring as a standard version. Working temperature from -30 °C up to +105 °C.  
Hose fittings with special O-rings (Viton or EPDM) available on request. For O-ring dimensions and part-numbers see Section Eb.

## CE Female Metric 24° Light Series with O-Ring Swivel – 45° Elbow

ISO 12151-2-SWE 45°-L – DKOL 45°

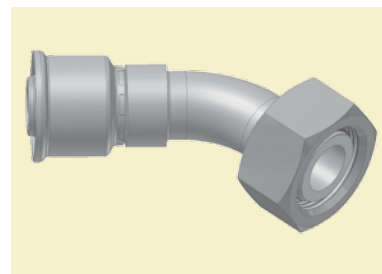
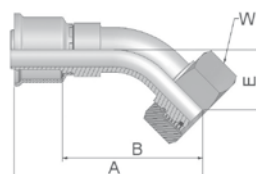

XXXXX-XX-XX Part Number 26	Hose I.D.			Thread metric	Tube O.D. mm	A mm	B mm	E mm	W mm
	Inch	Size	mm						
1CE26-10-6	5/16	-6	8.0	M16x1.5	10	66	45	17	19
1CE26-12-6	5/16	-6	8.0	M18x1.5	12	66	45	17	22
1CE26-12-8	13/32	-8	10.0	M18x1.5	12	59	39	17	22
1CE26-15-8	13/32	-8	10.0	M22x1.5	15	60	39	17	27
1CE26-18-10	1/2	-10	12.5	M26x1.5	18	69	46	21	32
1CE26-18-12	5/8	-12	16.0	M26x1.5	18	73	50	22	32
1CE26-22-12	5/8	-12	16.0	M30x2	22	77	55	26	36
1CE26-28-16	7/8	-16	22.0	M36x2	28	103	76	33	41

Hose fittings are delivered with ozone resistant Nitrile (NBR) O-ring as a standard version. Working temperature from -30 °C up to +105 °C.  
Hose fittings with special O-rings (Viton or EPDM) available on request. For O-ring dimensions and part-numbers see Section Eb.

Approved **fitting series** for hose types:

26 201 206 213 221FR 285 293

# CF Female Metric 24° Light Series with O-Ring Swivel – 90° Elbow

ISO 12151-2-SWE-L – DKOL 90°

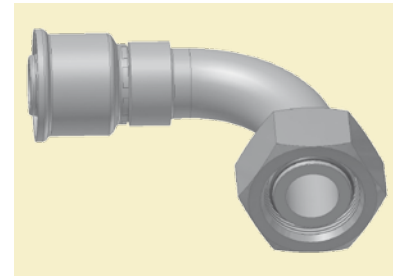
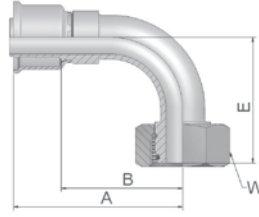

XXXXX-XX-XX Part Number 26	Hose I.D.		Thread metric	Tube O.D. mm	A mm	B mm	E mm	W mm	
	Inch	Size							mm
1CF26-8-4	3/16	-4	5.0	M14x1.5	8	48	28	29	17
1CF26-10-5	1/4	-5	6.3	M16x1.5	10	55	36	29	19
1CF26-10-6	5/16	-6	8.0	M16x1.5	10	55	34	31	19
1CF26-12-6	5/16	-6	8.0	M18x1.5	12	56	35	35	22
1CF26-12-8	13/32	-8	10.0	M18x1.5	12	51	30	31	22
1CF26-15-8	13/32	-8	10.0	M22x1.5	15	58	38	41	27
1CF26-18-10	1/2	-10	12.5	M26x1.5	18	57	34	38	32
1CF26-18-12	5/8	-12	16.0	M26x1.5	18	69	46	45	32
1CF26-22-12	5/8	-12	16.0	M30x2	22	78	55	47	36
1CF26-18-16	7/8	-16	22.0	M26x1.5	18	92	65	70	32
1CF26-28-16	7/8	-16	22.0	M36x2	28	95	68	71	41
1CF26-28-20	1-1/8	-20	29.0	M36x2	28	117	90	81	41
1CF26-35-20	1-1/8	-20	29.0	M45x2	35	117	90	77	50
1CF26-35-24	1-3/8	-24	35.0	M45x2	35	117	89	79	50

Hose fittings are delivered with ozone resistant Nitrile (NBR) O-ring as a standard version. Working temperature from -30 °C up to +105 °C. Hose fittings with special O-rings (Viton or EPDM) available on request. For O-ring dimensions and part-numbers see Section Eb.

# 49 Metric Banjo Straight

DIN 7642

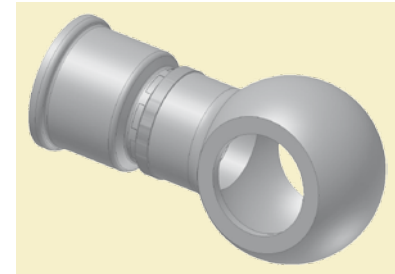
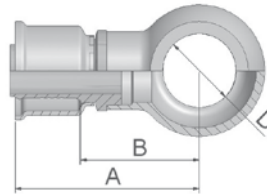

XXXXX-XX-XX Part Number 26	Hose I.D.		A mm	B mm	D mm	
	Inch	Size				mm
14926-12-6	5/16	-6	8.0	47	26	12
14926-14-6	5/16	-6	8.0	49	28	14
14926-14-8	13/32	-8	10.0	48	28	14
14926-16-8	13/32	-8	10.0	50	30	16
14926-33.4-20	1-1/8	-20	29.0	75	48	33

Approved fitting series for hose types:

26 201 206 213 221FR 285 293

## 92 Female BSP Parallel Pipe Swivel – Straight (60° Cone)

BS5200-A – DKR

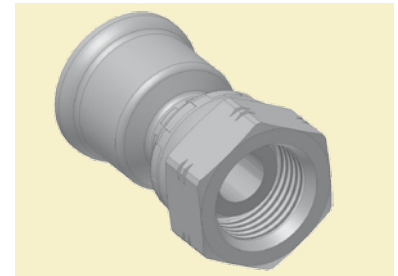
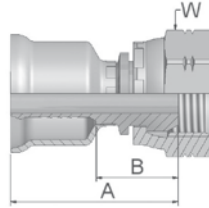

XXXXX-XX-XX Part Number 26	Hose I.D.			Thread BSP	A mm	B mm	W mm
	Inch	Size	mm				
19226-4-4	3/16	-4	5.0	1/4x19	41	20	19
19226-6-6	5/16	-6	8.0	3/8x19	42	21	22
19226-6-8	13/32	-8	10.0	3/8x19	41	21	22
19226-8-8	13/32	-8	10.0	1/2x14	44	23	27
19226-8-10	1/2	-10	12.5	1/2x14	45	22	27
19226-12-12	5/8	-12	16.0	3/4x14	45	24	32
19226-16-16	7/8	-16	22.0	1x11	52	25	41
19226-20-20	1-1/8	-20	29.0	1-1/4x11	58	31	50

## B1 Female BSP Parallel Pipe Swivel 45° Elbow (60° Cone)

BS 5200-D – DKR 45°

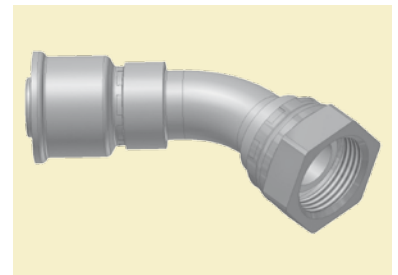
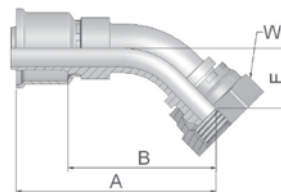

XXXXX-XX-XX Part Number 26	Hose I.D.			Thread BSP	A mm	B mm	E mm	W mm
	Inch	Size	mm					
1B126-4-4	3/16	-4	5.0	1/4x19	53	33	15	19
1B126-6-6	5/16	-6	8.0	3/8x19	56	36	16	22
1B126-8-8	13/32	-8	10.0	1/2x14	62	42	16	27
1B126-10-10	1/2	-10	12.5	5/8x14	67	44	20	30
1B126-12-12	5/8	-12	16.0	3/4x14	70	47	18	32

Approved **fitting series** for hose types:

26 201 206 213 221FR 285 293

## B2 Female BSP Parallel Pipe Swivel 90° Elbow (60° Cone)

BS 5200-B – DKR 90°

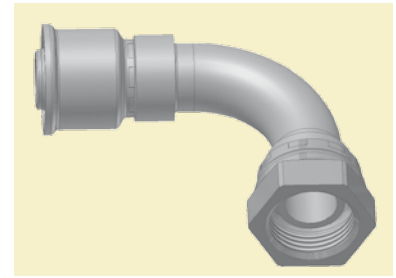
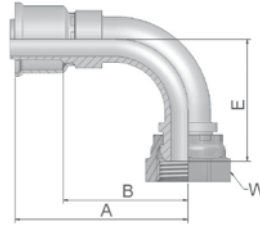

XXXXX-XX-XX Part Number 26	Hose I.D.			Thread BSP	A mm	B mm	E mm	W mm
	Inch	Size	mm					
1B226-4-4	3/16	-4	5.0	1/4x19	44	24	26	19
1B226-6-6	5/16	-6	8.0	3/8x19	47	26	29	22
1B226-8-8	13/32	-8	10.0	1/2x14	54	34	31	27
1B226-10-10	1/2	-10	12.5	5/8x14	57	34	36	30
1B226-12-12	5/8	-12	16.0	3/4x14	62	40	37	32
1B226-16-16	7/8	-16	22.0	1x11	96	69	67	41
1B226-20-20	1-1/8	-20	29.0	1-1/4x11	117	90	76	50

## 91 Male BSP Taper Pipe – Rigid Straight

BS5200 – AGR-K

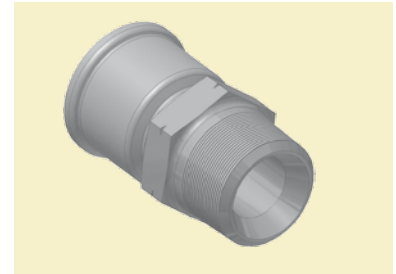
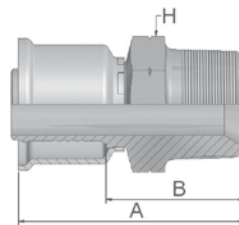

XXXXX-XX-XX Part Number 26	Hose I.D.			Thread BSP	A mm	B mm	H mm
	Inch	Size	mm				
19126-6-6	5/16	-6	8.0	3/8x19	47	26	19
19126-8-8	13/32	-8	10.0	1/2x14	53	32	22
19126-12-12	5/8	-12	16.0	3/4x14	58	36	30
19126-16-16	7/8	-16	22.0	1x11	69	43	36

Approved **fitting series** for hose types:

26 201 206 213 221FR 285 293

# 01

## Male NPTF Pipe Rigid – Straight

SAE J476A / J516 – AGN

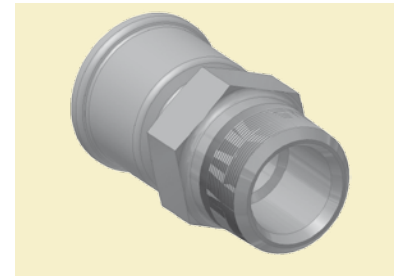
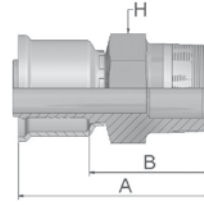

XXXXX-XX-XX Part Number 26	Hose I.D.			Thread NPTF	A mm	B mm	H Inch
	Inch	Size	mm				
10126-4-4	3/16	-4	5.0	1/4x18	48	26	9/16
10126-4-5	1/4	-5	6.3	1/4x18	48	26	9/16
10126-4-6	5/16	-6	8.0	1/4x18	48	26	3/4
10126-6-6	5/16	-6	8.0	3/8x18	48	26	11/16
10126-6-8	13/32	-8	10.0	3/8x18	48	26	11/16
10126-8-8	13/32	-8	10.0	1/2x14	54	33	7/8
10126-8-10	1/2	-10	12.5	1/2x14	57	33	7/8
10126-12-12	5/8	-12	16.0	3/4x14	59	35	1-1/16

# 06/68

## Female – JIC 37° SAE 45° Dual Flare Swivel – Straight

ISO12151-5-SWS – DKJ

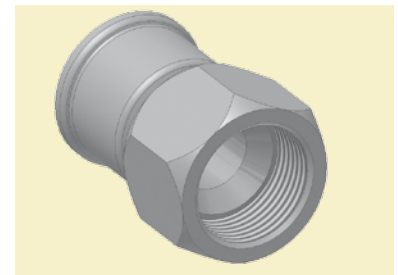
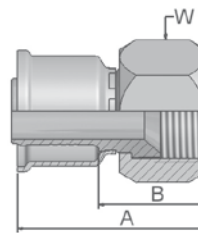

XXXXX-XX-XX Part Number 26	Hose I.D.			Thread UNF	Tube size Inch	A mm	B mm	W mm Inch
	Inch	Size	mm					
16826-4-4-SM	3/16	-4	5.0	7/16x20	1/4	43	24	14
16826-5-5-SM	1/4	-5	6.3	1/2x20	5/16	44	23	17
16826-5-5BA	1/4	-5	6.3	1/2x20	5/16	45	23	5/8
10626-6-6-SM	5/16	-6	8.0	9/16x18	3/8	45	24	19
10626-6-6	5/16	-6	8.0	9/16x18	3/8	45	23	11/16
16826-8-8-SM	13/32	-8	10.0	3/4x16	1/2	48	27	22
16826-8-10	1/2	-10	12.5	3/4x16	1/2	60	36	7/8
16826-10-10-SM	1/2	-10	12.5	7/8x14	5/8	54	32	27
16826-10-10BA	1/2	-10	12.5	7/8x14	5/8	55	31	1
16826-10-12-SM	5/8	-12	16.0	7/8x14	5/8	61	33	27
16826-10-12	5/8	-12	16.0	7/8x14	5/8	61	37	1
10626-12-12-SM	5/8	-12	16.0	1-1/16x12	3/4	56	34	32
10626-16-16-SM	7/8	-16	22.0	1-5/16x12	1	62	35	41
10626-20-20-SM	1-1/8	-20	29.0	1-5/8x12	1-1/4	66	39	50
10626-24-24-SM	1-3/8	-24	35.0	1-7/8x12	1-1/2	71	44	60
10626-32-32	1-13/16	-32	46.0	2-1/2x12	2	84	52	2-7/8

Approved fitting series for hose types:

BA: Nipple: Brass, Nut and Shell: Steel; SM: Metric Hexagon

26 201 206 213 221FR 285 293

**08** **Female SAE 45° – Swivel Straight**  
SAE J516

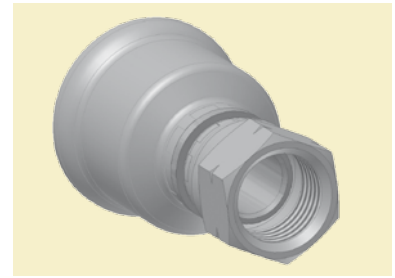
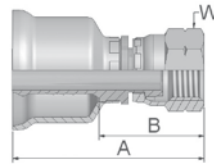

XXXXX-XX-XX Part Number 26	Hose I.D.			Thread UNF	Tube size Inch	A mm	B mm	W Inch
	Inch	Size	mm					
10826-6-6	5/16	-6	8.0	5/8x18	3/8	47	25	3/4
10826-6-6BA	5/16	-6	8.0	5/8x18	3/8	47	25	3/4
10826-12-12	5/8	-12	16.0	1-1/16x14	3/4	56	32	1-1/4

**37/3V** **Female JIC 37°**  
**SAE 45° – Dual Flare**  
**Swivel Female 45° Elbow**  
ISO 12151-5-SWE 45° – DKJ 45°

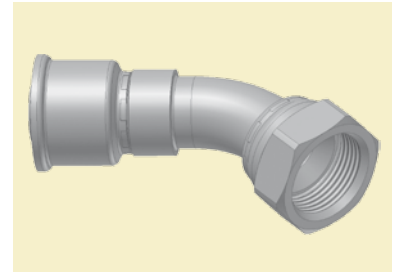
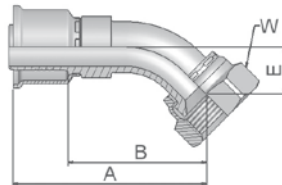

XXXXX-XX-XX Part Number 26	Hose I.D.			Thread UNF	Tube size Inch	A mm	B mm	E mm	W mm Inch
	Inch	Size	mm						
13V26-4-4-SM	3/16	-4	5.0	7/16x20	1/4	50	24	10	14
13726-6-6-SM	5/16	-6	8.0	9/16x18	3/8	54	33	11	19
13V26-8-8-SM	13/32	-8	10.0	3/4x16	1/2	59	38	15	22
13V26-10-10	1/2	-10	12.5	7/8x14	5/8	69	44	17	1
13726-12-12-SM	5/8	-12	16.0	1-1/16x12	3/4	75	53	20	32
13726-16-16-SM	7/8	-16	22.0	1-5/16x12	1	102	76	24	41

Approved **fitting series** for hose types:

BA: Nipple: Brass, Nut and Shell: Steel; SM: Metric Hexagon

26 201 206 213 221FR 285 293

**39/3W Female JIC 37°  
SAE 45° – Dual Flare  
Swivel Female 90° Elbow**

ISO 12151-5-SWES – DKJ 90°

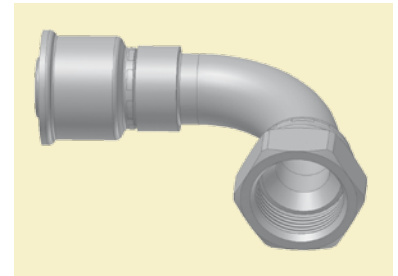
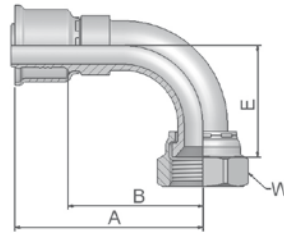

XXXXX-XX-XX Part Number 26	Hose I.D.			Thread UNF	Tube size Inch	A mm	B mm	E mm	W mm
	Inch	Size	mm						
13W26-4-4-SM	3/16	-4	5.0	7/16x20	1/4	45	20	21	14
13W26-5-5-SM	1/4	-5	6.3	1/2x20	5/16	50	30	20	17
13926-6-6-SM	5/16	-6	8.0	9/16x18	3/8	49	29	22	19
13W26-8-6-SM	5/16	-6	8.0	3/4x16	3/8	53	32	29	22
13W26-8-8-SM	13/32	-8	10.0	3/4x16	1/2	53	32	29	22
13W26-8-10-SM	1/2	-10	12.5	3/4x16	5/8	56	34	29	22
13W26-10-10-SM	1/2	-10	12.5	7/8x14	5/8	60	38	32	27
13W26-10-12-SM	5/8	-12	16.0	7/8x14	5/8	63	41	33	27
13926-12-12-SM	5/8	-12	16.0	1-1/16x12	3/4	73	51	46	32
13926-16-16-SM	7/8	-16	22.0	1-5/16x12	1	102	75	59	41
13926-20-20-SM	1-1/8	-20	29.0	1-5/8x12	1-1/4	109	81	70	50

Approved fitting series for hose types:

SM: Metric Hexagon

26 201 206 213 221FR 285 293

**JC** **Female ORFS  
Swivel – Straight  
Short**

ISO 12151-1 – SWSA  
SAE J516 – ORFS

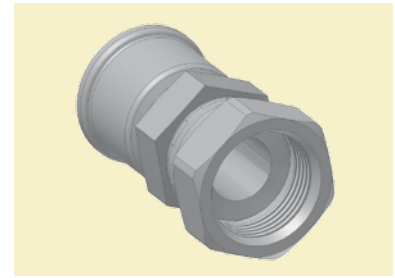
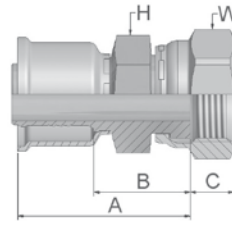

XXXXX-XX-XX Part Number	Hose I.D.			Thread UNF	A mm	B mm	C mm	H mm	W mm
	Inch	Size	mm						
26 1JC26-4-4-SM	3/16	-4	5.0	9/16x18	42	20	8	14	17
1JC26-6-6-SM	5/16	-6	8.0	11/16x16	36	15	-	-	22
1JC26-8-6-SM	5/16	-6	8.0	13/16x16	44	23	-	19	24
1JC26-8-8-SM	13/32	-8	10.0	13/16x16	37	17	11	-	24
1JC26-10-10-SM	1/2	-10	12.5	1x14	49	27	12	24	30
1JC26-12-12-SM	5/8	-12	16.0	1-3/16x12	43	21	14	-	36
1JC26-16-16-SM	7/8	-16	22.0	1-7/16x12	61	34	14	36	41
1JC26-20-20-SM	1-1/8	-20	29.0	1-11/16x12	62	35	15	50	50

Approved **fitting series** for hose types:

SM: Metric Hexagon

26 201 206 213 221FR 285 293



## 5S Female Tube O-ring Swivel Short Pilot

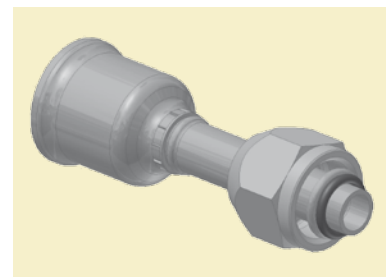
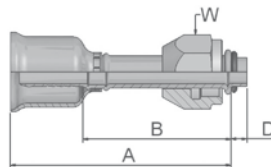

XXXXX-XX-XX Part Number 26					A	B	D	
	Inch	Size	mm					
15S26-6-6	5/16	-6	8.0	5/8x18	66	44	4.7	3/4
15S26-8-8	13/32	-8	10.0	3/4x16	67	45	4.7	7/8
15S26-10-10	1/2	-10	12.5	7/8x14	71	47	4.7	1-1/16

## 5H Female Tube O-Ring Swivel 45° Elbow – Short Pilot

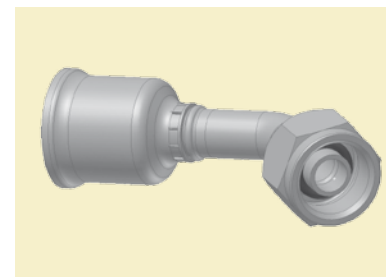
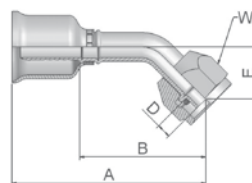

XXXXX-XX-XX Part Number 26					A	B	D	E	
	Inch	Size	mm						
15H26-6-6	5/16	-6	8.0	5/8x18	61	39	4.7	14	3/4
15H26-10-10	1/2	-10	12.5	7/8x14	77	53	4.7	17	1-1/16

Approved **fitting series** for hose types:

26 285

## 5T Female Tube O-Ring Swivel 90° Elbow – Short Pilot

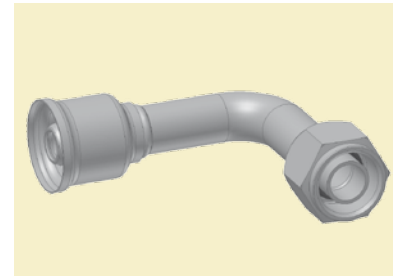
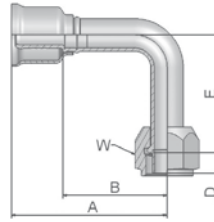

XXXXX-XX-XX Part Number 26					A	B	D	E	
	Inch	Size	mm						
15T26-6-6	5/16	-6	8.0	5/8x18	56	34	4.7	36	3/4
15T26-8-8	13/32	-8	10.0	3/4x16	63	41	4.7	37	7/8
15T26-10-10	1/2	-10	12.5	7/8x14	73	49	4.7	44	1-1/16

## 59PT Male Tube O-Ring Swivel Long Pilot

With Charge Port at 180° for R134a

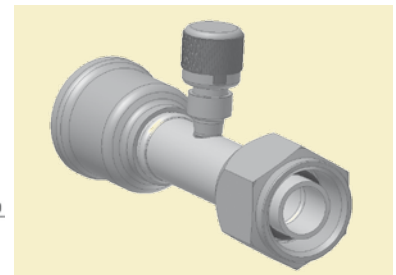
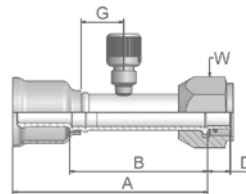

XXXXX-XX-XX Part Number 26					A	B	D	G	
	Inch	Size	mm						
15926-6-6-PT	5/16	-6	8.0	5/8x18	83	61	7.1	13	3/4
15926-8-8-PT	13/32	-8	10.0	3/4x16	74	52	9.8	13	7/8
15926-10-12-PT	5/8	-12	16.0	7/8x14	88	65	9.8	15	1-1/16



Approved **fitting series** for hose types:

26 285

# 5LPT Female Tube O-Ring Swivel 90° Elbow – Long Pilot

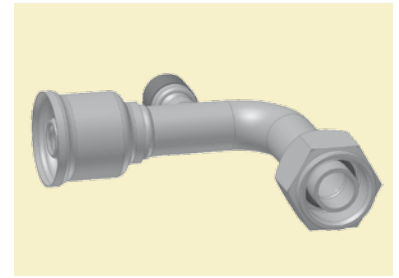
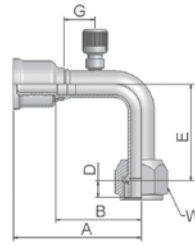
With Charge Port at 180° for R134a



XXXXX-XX-XX Part Number 26				 Thread UNF	A mm	B mm	D mm	E mm	G mm	 W Inch
	Inch	Size	mm							
15L26-8-8-PT	13/32	-8	10.0	3/4x16	82	60	9.8	37	15	7/8
15L26-10-10-PT	1/2	-10	12.5	7/8x14	91	67	9.8	57	15	1-1/16
15L26-10-12-PT	5/8	-12	16.0	7/8x14	91	67	9.8	57	15	1-1/16

Approved **fitting series** for hose types:

26 285





aerospace  
climate control  
electromechanical  
filtration  
fluid & gas handling  
hydraulics  
pneumatics  
process control  
sealing & shielding



# Hydraulic Hoses and Fittings

Medium pressure



ENGINEERING YOUR SUCCESS.

# Medium-Pressure Hoses and Fittings

The perfect range for the more demanding market requirements



This medium-pressure hose range contains the Elite No-Skive compact hydraulic hoses exceeding ISO and EN specifications and the

classic No-Skive hydraulic hoses according to ISO, EN and SAE specifications. This hose range is complemented by a full selection

of compatible No-Skive fittings in steel and stainless steel.

- Extended range of working temperatures:  
-50 °C up to +150 °C
- Selected hoses feature nitrile inner tubes suitable for mineral and bio-degradable oils
- Full range of fluid compatibility; oil, water, phosphate ester etc.
- Using high quality compounds allows thin covers – less weight – long service life still assured
- High flexibility for easier installation and increased service life

- Small bend radii and light weight for applications where space and weight are determining factors
- High abrasion resistance hose covers superior to ISO 6945 requirements, extending service life
- High ozone-resistant cover compounds extending weathering and ageing resistance
- Parkrimp machines, portable or bench mounted for easy assembly operation – hose assemblies meet CE directives



- Complete No-Skive fitting technology across the full range of medium pressure hoses providing simpler, quicker and safer hose assembly

# Parkrimp® *No-Skive*

The system for fast and leak-free assemblies

- No skiving tool needed
- No need to remove the cover
- Crimps one-piece fittings
- Parkalign positions the fittings in the dies perfectly every time
- Quick and easy: no gauges to set on the machine
- Portable machines for field repair
- Meets EN safety regulations

## The perfect match



The complete system from one source. No-Skive hose, No-Skive fitting and crimping machine with world-wide guarantee and availability.

## Parker's colour-coded die sets



No loose parts to mismatch or misplace – die set segments linked together. Die sets provide 360° evenly applied crimping forces for an ideal crimp result.

## Parkalign®



Parker's exclusive Parkalign® positions the fitting in the dies perfectly every time.



# Applications

The definitive hose range for all medium-pressure applications



# Universal Push-to-Connect (UPTC)

The unique push-in system for tubes and hoses

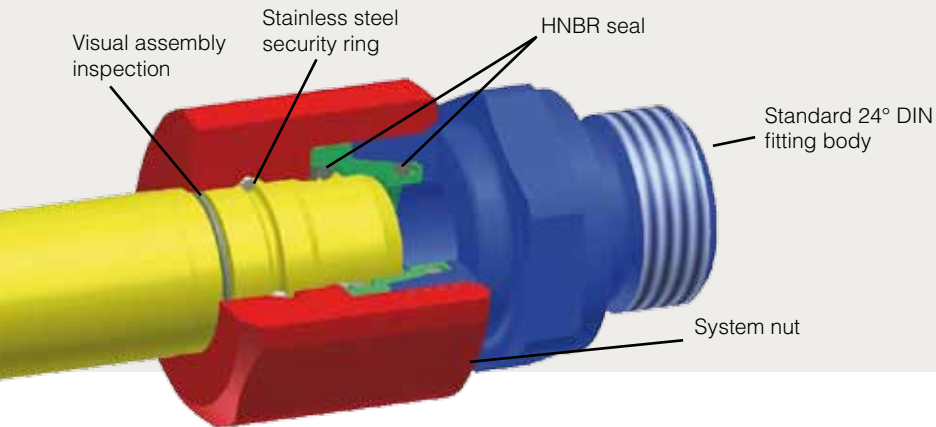

**As a standard solution it's a stroke of genius**

Parker's UPTC is the standardised push-in system for Parker 24° DIN fitting bodies.

## In use with tube and hose

Because of its flexibility, UPTC is a unique push-in system for tube and hose terminations.



## Assembly

- Simply introduce the hose or tube into the works-assembled fitting and push in.

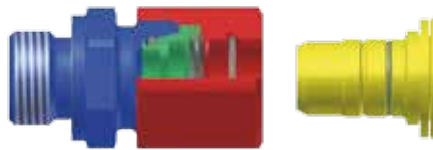

## Assembled connector

### Simple

- Visual assembly inspection
- Marker inside the nut = unambiguous assembly results

### Safe

- Security ring locks in place
- Termination is held in the connector

### Leak-proof

- Elastomeric seal
- 100 % leak-proof

## Disassembly

- Removable and fit for reassembly just like conventional screw fittings – possible even in very dirty conditions
- Repair-friendly
- No special tools required

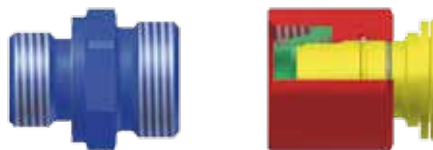
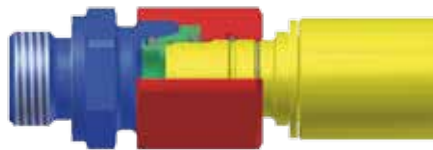

## Examples

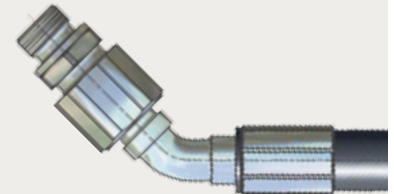

For more information about UPTC please refer to pages Cb-47 – Cb-48



# Parkrimp No-Skive Hoses and Fittings

Medium pressure	No-Skive Hose	301SN	<i>No-Skive</i>	Ca-1
		301TC	<i>No-Skive</i>	Ca-2
		302	<i>No-Skive</i>	Ca-3
		304	<i>No-Skive</i>	Ca-4
		351TC	<i>No-Skive</i>	Ca-5
		402	<i>No-Skive</i>	Ca-6
		412	<i>No-Skive</i>	Ca-7
		421RH	<i>No-Skive</i>	Ca-8
		421SN	<i>No-Skive</i>	Ca-9
		421WC	<i>No-Skive</i>	Ca-10
		422	<i>No-Skive</i>	Ca-11
		424	<i>No-Skive</i>	Ca-12
		426	<i>No-Skive</i>	Ca-13
		436	<i>No-Skive</i>	Ca-14
		441	<i>No-Skive</i>	Ca-15
		441RH	<i>No-Skive</i>	Ca-16
		451	<i>No-Skive</i>	Ca-17
		451TC	<i>No-Skive</i>	Ca-18
		461LT	<i>No-Skive</i>	Ca-19
		462	<i>No-Skive</i>	Ca-20
		462ST	<i>No-Skive</i>	Ca-21
		463	<i>No-Skive</i>	Ca-22
		471TC	<i>No-Skive</i>	Ca-23
		472TC	<i>No-Skive</i>	Ca-23
		477	<i>No-Skive</i>	Ca-24
		477ST	<i>No-Skive</i>	Ca-25
		492	<i>No-Skive</i>	Ca-26
		492ST	<i>No-Skive</i>	Ca-27
		493	<i>No-Skive</i>	Ca-28
		692	<i>No-Skive</i>	Ca-29
		692Twin	<i>No-Skive</i>	Ca-30
		811	<i>No-Skive</i>	Ca-31
881	<i>No-Skive</i>	Ca-32		
Fittings 46 and 48 series	DIN – Metric		Cb-1 – Cb-12	
	BSP		Cb-13 – Cb-19	
	SAE		Cb-20 – Cb-27	
	Flange		Cb-28 – Cb-32	
	ORFS		Cb-33 – Cb-38	
	JIS		Cb-39 – Cb-40	
	French Standard		Cb-41 – Cb-43	
	High Pressure Cleaning		Cb-44 – Cb-45	
	Others		Cb-46	
	UPTC		Cb-47 – Cb-48	

Parker Hannifin assumes no liability for typographical errors or other errors

## Standard

<b>301SN</b> Ca-1  <i>No-Skive</i> DIN EN 853 2SN – ISO 1436 Type 2	<b>302</b> Ca-3  WORLDWIDE <i>No-Skive</i> DIN EN 853 2SN – ISO S 1436	<b>421SN</b> Ca-9  <i>No-Skive</i> DIN EN 853 1SN – ISO 1436 Type 1	<b>422</b> Ca-11  WORLDWIDE <i>No-Skive</i> ISO 1436 1SN
<b>441</b> Ca-15  <i>No-Skive</i> ISO 11237 Type R16 – SAE 100R16	<b>451</b> Ca-17  <i>No-Skive</i> ISO 11237 Type R17 – SAE 100R17	<b>462</b> Ca-20  Elite Compact DIN EN 857 2SC – ISO 11237 Type 2SC	<b>492</b> Ca-26  Elite Compact DIN EN 857 1SC – ISO 11237 Type 1SC

## High abrasion resistance – MSHA approved

<b>301TC</b> Ca-2  <i>No-Skive Tough Cover</i> DIN EN 853 2SN – ISO 1436 Type 2	<b>351TC</b> Ca-5  <i>No-Skive Tough Cover</i> ISO 11237 Type R19 – SAE 100R19	<b>451TC</b> Ca-18  <i>No-Skive Tough Cover</i> ISO 11237 Type R17 – SAE 100R17	<b>471TC / 472TC</b> Ca-23  <i>No-Skive</i> DIN EN 857 2SC – ISO 11237 Type 2SC
---	--	--	---

## Extreme abrasion resistance

<b>462ST</b> Ca-21  Elite Super Tough Compact DIN EN 857 2SC – ISO 11237 Type 2SC	<b>492ST</b> Ca-27  Elite Super Tough Compact DIN EN 857 1SC – ISO 11237 Type 1SC
---	---

## Low / High temperature

<b>426</b> Ca-13  <i>No-Skive</i> SAE 100R1AT high temperature	<b>436</b> Ca-14  <i>No-Skive Compact</i> SAE 100R16 high temperature	<b>461LT</b> Ca-19  Elite Compact DIN EN 857 2SC low temperature
--	---	---

## Phosphate Ester

<b>304</b> Ca-4  <i>No-Skive</i> Phosphate ester resistant hose	<b>424</b> Ca-12  <i>No-Skive</i> Phosphate ester resistant hose
---	--

## Railway

<b>421RH</b> Ca-8  <i>No-Skive</i> Fire-retardant cover	<b>441RH</b> Ca-16  <i>No-Skive Compact</i> Fire-retardant cover
---	--

## Water cleaning

<p><b>463</b> Ca-22</p>  <p><i>No-Skive Compact</i> High pressure water cleaning applications</p>	<p><b>493</b> Ca-28</p>  <p><i>No-Skive Compact</i> High pressure water cleaning applications</p>
--	--



## Pilot

<p><b>402</b> Ca-6</p>  <p><i>Elite Compact</i> Pilot line applications</p>	<p><b>412</b> Ca-7</p>  <p><i>RemoFlex No-Skive</i> 1 wire braided hose for pilot lines</p>
--	--

## Wire cover

<p><b>421WC</b> Ca-10</p>  <p><i>No-Skive</i> Galvanised steel wire cover</p>
--

## PowerLift

<p><b>477</b> Ca-24</p>  <p><i>PowerLift No-Skive</i> 2 wire braided</p>	<p><b>477ST</b> Ca-25</p>  <p><i>PowerLift No-Skive</i> 2 wire braided</p>
---	---

## Extremely flexible

<p><b>692</b> Ca-29</p>  <p><i>Elite Compact</i> Constant pressure, tight bend radius</p>	<p><b>692Twin</b> Ca-30</p>  <p><i>Elite Compact</i> Twin constant pressure, tight bend radius</p>
--	---

## Suction

<p><b>811</b> Ca-31</p>  <p><i>No-Skive Suction and Return Line</i> SAE 100R4</p>	<p><b>881</b> Ca-32</p>  <p><i>No-Skive Suction and Return Line</i> SAE 100R4</p>
--	--



# 301SN

*No-Skive*

DIN EN 853 2SN – ISO 1436 Type 2



- *No-Skive* thin cover hose construction
- Nitrile (NBR) inner tube  
– extended fluid compatibility
- Suitable with 48 series fittings

## Primary Applications

General medium pressure hydraulic applications

## Type Approvals

Details please find on pages **Ab-14** and **Ab-15**

## Applicable Specifications

DIN EN 853 2SN – ISO 1436 Type 2 – SAE 100R2AT

## Construction

Tube: Nitrile (NBR)  
Reinforcement: Two high-tensile steel wire braids  
Cover: Synthetic rubber

Temperature Range ..... -40 °C up to +100 °C

Exception: Air ..... max. +70 °C  
Water ..... max. +85 °C

## Recommended Fluids

Petroleum and water-glycol based fluids, lubricating oils, air and water. For air above 1.7 MPa, the hose cover must be pin-pricked.

Consult the chemical compatibility section on pages **Ab-22** to **Ab-30** for more detailed information.

## Fitting Series



Part Number	Hose I.D.				Hose O.D. mm	Pressure Rating				min. bend radius mm	weight kg
	DN	Inch	Size	mm		max. working pressure		min. burst pressure			
						MPa	psi	MPa	psi		
301SN-4	6	1/4	-4	6.3	15.0	40.0	5800	160.0	23200	100	0.39
301SN-5	8	5/16	-5	7.9	16.6	35.0	5075	140.0	20300	115	0.42
301SN-6	10	3/8	-6	9.5	19.0	33.0	4775	132.0	19100	130	0.55
301SN-8	12	1/2	-8	12.7	22.2	27.5	4000	110.0	16000	180	0.67
301SN-10	16	5/8	-10	15.9	25.4	25.0	3600	100.0	14500	200	0.77
301SN-12	20	3/4	-12	19.1	29.3	21.5	3100	86.0	12400	240	1.00
301SN-16	25	1	-16	25.4	38.1	16.5	2400	66.0	9600	300	1.49
301SN-20	32	1-1/4	-20	31.8	47.5	12.5	1800	50.0	7200	420	1.73
301SN-24	40	1-1/2	-24	38.1	55.0	9.0	1300	36.0	5200	500	2.14
301SN-32	50	2	-32	50.8	67.0	8.0	1150	32.0	4600	630	2.96

The combination of high temperature and high pressure could reduce the hose life.

# 301TC

## No-Skive Tough Cover

DIN EN 853 2SN – ISO 1436 Type 2

### Primary Applications

General medium pressure hydraulic applications where high abrasion is required

### Type Approvals

Details please find on pages **Ab-14** and **Ab-15**

### Applicable Specifications

DIN EN 853 2SN – ISO 1436 Type 2 – SAE 100R2AT

### Construction

Tube: Nitrile (NBR)  
Reinforcement: Two high-tensile steel wire braids  
Cover: MSHA approved synthetic rubber

Temperature Range ..... -40 °C up to +100 °C

Exception: Air ..... max. +70 °C

Water ..... max. +85 °C



- *No-Skive* thin cover hose construction
- Nitrile (NBR) inner tube – extended fluid compatibility
- Highly abrasion resistant **TOUGH COVER**
- MSHA approved
- Hose is suitable for temporary immersion in mineral oil up to 70 °C with frequent inspections

### Recommended Fluids

Petroleum and water-glycol based fluids, lubricating oils, air and water. For air above 1.7 MPa, the hose cover must be pin-pricked.

Consult the chemical compatibility section on pages **Ab-22** to **Ab-30** for more detailed information.

### Fitting Series



Part Number	Hose I.D.				Hose O.D. mm	Pressure Rating				min. bend radius mm	weight kg
	DN	Inch	Size	mm		max. working pressure		min. burst pressure			
						MPa	psi	MPa	psi		
301TC-4	6	1/4	-4	6.3	15.0	40.0	5800	160.0	23200	100	0.39
301TC-5	8	5/16	-5	7.9	16.6	35.0	5075	140.0	20300	115	0.42
301TC-6	10	3/8	-6	9.5	19.0	33.0	4775	132.0	19100	130	0.55
301TC-8	12	1/2	-8	12.7	22.2	27.5	4000	110.0	16000	180	0.67
301TC-10	16	5/8	-10	15.9	25.4	25.0	3600	100.0	14500	200	0.77
301TC-12	20	3/4	-12	19.1	29.3	21.5	3100	86.0	12400	240	1.00
301TC-16	25	1	-16	25.4	38.1	16.5	2400	66.0	9600	300	1.49
301TC-20	32	1-1/4	-20	31.8	47.5	12.5	1800	50.0	7200	420	1.73
301TC-24	40	1-1/2	-24	38.1	55.0	9.0	1300	36.0	5200	500	2.14
301TC-32	50	2	-32	50.8	67.0	8.0	1150	32.0	4600	630	2.96

Replace the hose when any deformation or damage on the hose cover are visible. The combination of high temperature and high pressure could reduce the hose life.

# 302

**WORLDWIDE** *No-Skive*  
DIN EN 853 2SN – ISO S 1436



- Meets ISO 1436
- Worldwide availability
- Worldwide consistent appearance, part number and functionality
- *No-Skive* thin cover hose construction
- Extended fluid compatibility (including biodegradable oils)

## Primary Applications

General medium pressure hydraulic applications

## Type Approvals

Details please find on pages **Ab-14** and **Ab-15**

## Applicable Specifications

DIN EN 853 2SN – ISO S 1436 – SAE 100R2AT

## Construction

Tube: Nitrile (NBR)  
Reinforcement: Two high-tensile steel wire braids  
Cover: Synthetic rubber

Temperature Range ..... -40 °C up to +100 °C

Exception: Air ..... max. +70 °C  
Water ..... max. +85 °C

## Recommended Fluids

Petroleum and water-glycol based fluids, lubricating oils, air and water. For air above 1.7 MPa, the hose cover must be pin-pricked.

Consult the chemical compatibility section on pages **Ab-22** to **Ab-30** for more detailed information.

## Fitting Series



Part Number	Hose I.D.				Hose O.D. mm	Pressure Rating				min. bend radius mm	weight kg
	DN	Inch	Size	mm		max. working pressure		min. burst pressure			
						MPa	psi	MPa	psi		
302-4	6	1/4	-4	6.3	15.0	40.0	5800	160.0	23200	100	0.39
302-5	8	5/16	-5	7.9	16.6	35.0	5075	140.0	20300	115	0.42
302-6	10	3/8	-6	9.5	19.0	33.0	4775	132.0	19100	130	0.55
302-8	12	1/2	-8	12.7	22.2	27.5	4000	110.0	16000	180	0.67
302-10	16	5/8	-10	15.9	25.4	25.0	3600	100.0	14500	200	0.77
302-12	20	3/4	-12	19.1	29.3	21.5	3100	86.0	12400	240	1.00
302-16	25	1	-16	25.4	38.1	16.5	2400	66.0	9600	300	1.49
302-20	32	1-1/4	-20	31.8	47.5	12.5	1800	50.0	7200	420	1.73
302-24	40	1-1/2	-24	38.1	55.0	9.0	1300	36.0	5200	500	2.14
302-32	50	2	-32	50.8	67.0	8.0	1150	32.0	4600	630	2.96

The combination of high temperature and high pressure could reduce the hose life.

# 304

*No-Skive*

Phosphate ester resistant hose

## Primary Applications

Aerospace, foundries, steel mills:  
Medium pressure hydraulic applications with phosphate ester fluids

## Applicable Specifications

Parker specification

## Restrictions

Do not allow tube to contact any petroleum base fluids.  
Use liquid soap as hose lubricant.

## Construction

Tube: EPDM synthetic rubber  
Reinforcement: Two high-tensile steel wire braids  
Cover: Green EPDM synthetic rubber

Temperature Range ..... -40 °C up to +80 °C

Exception: Air ..... max. +70 °C  
Water, water glycol fluids .. max. +85 °C



- *No-Skive* thin cover hose construction
- EPDM hose resistant to phosphate ester fluids
- SAE 100R2 pressure rating

## Recommended Fluids

Phosphate ester based hydraulic fluids, water-glycol based fluids, air and water.  
Consult the chemical compatibility section on pages **Ab-22** to **Ab-30** for more detailed information.

## Fitting Series

Series 48 for sizes -20 to -32

\*Series 43 for sizes -4 to -32 available on request



Part Number	Hose I.D.				Hose O.D. mm	Pressure Rating				min. bend radius mm	weight kg
	DN	Inch	Size	mm		max. working pressure		min. burst pressure			
						MPa	psi	MPa	psi		
304-4	6	1/4	-4	6.3	15.0	34.5	5000	138.0	20000	100	0.39
304-6	10	3/8	-6	9.5	19.0	27.5	4000	110.0	16000	130	0.55
304-8	12	1/2	-8	12.7	22.0	24.0	3500	96.0	14000	180	0.67
304-12	20	3/4	-12	19.1	30.0	15.5	2250	62.0	9000	240	1.00
304-16	25	1	-16	25.4	38.0	13.8	2000	55.0	8000	300	1.49
304-20	32	1-1/4	-20	31.8	48.0	11.2	1625	45.0	6500	420	1.73
304-24	40	1-1/2	-24	38.1	55.0	8.6	1250	35.0	5075	500	2.14
304-32	50	2	-32	50.8	68.0	7.8	1125	31.0	4500	630	2.96

The combination of high temperature and high pressure could reduce the hose life.



# 351TC

## No-Skive Tough Cover

ISO 11237 Type R19 – SAE 100R19

### Primary Applications

General medium pressure hydraulic applications where higher abrasion resistance is required

### Type Approvals

Details please find on pages **Ab-14** and **Ab-15**

### Applicable Specifications

ISO 11237 Type R19 – SAE 100R19

### Construction

Tube: Synthetic rubber  
Reinforcement: Two high-tensile steel wire braids  
Cover: MSHA approved synthetic rubber

Temperature Range ..... -40 °C up to +100 °C

Exception: Air ..... max. +70 °C  
Water ..... max. +85 °C



- *No-Skive* thin cover hose construction
- Constant working pressure of 28.0 MPa
- Highly abrasion resistant **TOUGH COVER**
- MSHA approved
- Hose is suitable for temporary immersion in mineral oil up to 70 °C with frequent inspections

### Recommended Fluids

Petroleum and water-glycol based fluids, lubricating oils, air and water. For air above 1.7 MPa, the hose cover must be pin-pricked.

Consult the chemical compatibility section on pages **Ab-22** to **Ab-30** for more detailed information.

### Fitting Series



Part Number	Hose I.D.				Hose O.D.	Pressure Rating				min. bend radius	weight
	DN	Inch	Size	mm	mm	max. working pressure		min. burst pressure			
						MPa	psi	MPa	psi		
351TC-4	6	1/4	-4	6.3	13.0	28.0	4000	112.0	1600	50	0.30
351TC-6	10	3/8	-6	9.5	17.0	28.0	4000	112.0	1600	65	0.42
351TC-8	12	1/2	-8	12.7	20.0	28.0	4000	112.0	1600	90	0.52
351TC-10	16	5/8	-10	15.9	24.0	28.0	4000	112.0	1600	100	0.66
351TC-12	20	3/4	-12	19.1	28.0	28.0	4000	112.0	1600	120	0.86

Replace the hose when any deformation or damage on the hose cover are visible.  
The combination of high temperature and high pressure could reduce the hose life.

# 402

## Elite Compact

Pilot line applications



- *No-Skive* thin cover Compact hose
- Constant working pressure of 10.0 MPa

### Primary Applications

Mobile hydraulic: Pilot lines

### Construction

Tube: Nitrile (NBR)  
Reinforcement: One high-tensile steel wire braid  
Cover: Synthetic rubber

Temperature Range ..... -40 °C up to +100 °C

Exception: Air ..... max. +70 °C

Water ..... max. +85 °C

### Recommended Fluids

Petroleum and water-glycol based fluids, lubricating oils, air and water. For air above 1.7 MPa, the hose cover must be pin-pricked.

Consult the chemical compatibility section on pages **Ab-22** to **Ab-30** for more detailed information.

### Fitting Series

- Available as complete hose assembly
- Compatible with 2-piece fittings for use with adjustable crimpers only (47 series nipple and 10049 series shell)

Part Number	Hose I.D.				Hose O.D. mm	Pressure Rating				min. bend radius mm	weight kg
	DN	Inch	Size	mm		max. working pressure		min. burst pressure			
						MPa	psi	MPa	psi		
402-4	6	1/4	-4	6.3	11.6	10.0	1450	40.0	5800	50	0.15
402-5	8	5/16	-5	7.9	13.2	10.0	1450	40.0	5800	60	0.18
402-6	10	3/8	-6	9.5	14.8	10.0	1450	40.0	5800	65	0.21
402-8	12	1/2	-8	12.7	18.6	10.0	1450	40.0	5800	75	0.29

The combination of high temperature and high pressure could reduce the hose life.

# 412 / 412ST

## RemoFlex *No-Skive*

1 wire braided hose for pilot lines



- *No-Skive* hose construction
- 12.0 MPa rubber pilot line hose (20 % higher working pressure than 402 hose)
- Very tight bending radii – allowing compact machine design
- 412ST with extrem abrasion resistant cover **SUPER TOUGH**

### Primary Applications

Mobile hydraulic equipment:Pilot lines

### Construction

Tube: Nitrile (NBR)  
 Reinforcement: One high-tensile steel wire braid  
 Cover 412: Synthetic rubber  
 Cover 412ST: Synthetic rubber  
 with a special polyethylene coating

### Recommended Fluids

Petroleum and water-glycol based fluids, lubricating oils, air and water. For air above 1.7 MPa, the hose cover must be pin-pricked.

Consult the chemical compatibility section on pages **Ab-22** to **Ab-30** for more detailed information.

Temperature Range ..... -40 °C up to +100 °C

Exception: Air ..... max. +70 °C

Water ..... max. +85 °C

### Fitting Series

- Available as complete hose assembly
- Compatible with 2-piece fittings for use with adjustable crimpers only (47 series nipple and 10049 series shell)

Part Number	Hose I.D.				Hose O.D. mm	Pressure Rating				min. bend radius mm	weight kg
	DN	Inch	Size	mm		max. working pressure		min. burst pressure			
						MPa	psi	MPa	psi		
412-3	5	3/16	-3	4.6	9.1	12.0	1700	48.0	6800	20	0.08
412-4	6	1/4	-4	6.3	11.0	12.0	1700	48.0	6800	25	0.14
412-5	8	5/16	-5	7.9	13.0	12.0	1700	48.0	6800	30	0.18
412-6	10	3/8	-6	9.5	14.0	12.0	1700	48.0	6800	40	0.23
412ST-3	5	3/16	-3	4.6	9.6	12.0	1700	48.0	6800	20	0.08
412ST-4	6	1/4	-4	6.3	11.6	12.0	1700	48.0	6800	25	0.14
412ST-5	8	5/16	-5	7.9	13.0	12.0	1700	48.0	6800	30	0.18
412ST-6	10	3/8	-6	9.5	14.0	12.0	1700	48.0	6800	40	0.23

The combination of high temperature and high pressure could reduce the hose life.

# 421RH

*No-Skive*

Fire-retardant cover

## Primary Applications

General medium-pressure hydraulic and pneumatic systems as well as water and oil cooling circuits

## Type Approvals

Details please find on pages **Ab-14** and **Ab-15**

## Applicable Specifications

DIN EN 853 1SN – ISO 1436 Typ 1 – SAE 100R1AT

## Construction

Tube: Nitrile (NBR)  
Reinforcement: One high-tensile steel wire braid  
Cover: Fire retardant synthetic rubber

Temperature Range ..... -40 °C up to +100 °C

Exception: Air ..... max. +70 °C

Water ..... max. +85 °C



- *No-Skive* thin cover hose construction
- Nitrile (NBR) inner tube  
– extended fluid compatibility
- Suitable with 48 series fittings
- Fire-retardant cover
- German Standard: **DIN 5510-2**
- French Standard: **NF F16-101/102 I2/F3**
- British Standard: **BS 6853 - Table 4**

## Recommended Fluids

Petroleum and water-glycol based fluids, lubricating oils, air and water. For air and gas above 1.7 MPa, the hose cover must be pin-pricked.

Consult the chemical compatibility section on pages **Ab-22** to **Ab-30** for more detailed information.

## Fitting Series



Part Number	Hose I.D.				Hose O.D. mm	Pressure Rating				min. bend radius mm	weight kg
	DN	Inch	Size	mm		max. working pressure		min. burst pressure			
						MPa	psi	MPa	psi		
421RH-20	32	1-1/4	-20	31.8	44.8	6.3	900	25.0	3600	420	1.19
421RH-24	40	1-1/2	-24	38.1	51.1	5.0	725	20.0	2900	500	1.49
421RH-32	50	2	-32	50.8	64.7	4.0	575	16.0	2300	630	2.23

The combination of high temperature and high pressure could reduce the hose life.

# 421SN

*No-Skive*

DIN EN 853 1SN – ISO 1436 Type 1



- *No-Skive* thin cover hose construction
- Nitrile (NBR) inner tube  
– extended fluid compatibility

## Primary Applications

General medium pressure hydraulic applications

## Type Approvals

Details please find on pages **Ab-14** and **Ab-15**

## Applicable Specifications

DIN EN 853 1SN – ISO 1436 Type 1 – SAE 100R1AT

## Construction

Tube: Nitrile (NBR)  
Reinforcement: One high-tensile steel wire braid  
Cover: Synthetic rubber

Temperature Range ..... -40 °C up to +100 °C

Exception: Air ..... max. +70 °C  
Water ..... max. +85 °C

## Recommended Fluids

Petroleum and water-glycol based fluids, lubricating oils, air and water. For air above 1.7 MPa, the hose cover must be pin-pricked.

Consult the chemical compatibility section on pages **Ab-22** to **Ab-30** for more detailed information.

## Fitting Series



Part Number	Hose I.D.				Hose O.D. mm	Pressure Rating				min. bend radius mm	weight kg
	DN	Inch	Size	mm		max. working pressure		min. burst pressure			
						MPa	psi	MPa	psi		
421SN-4	6	1/4	-4	6.3	13.4	22.5	3250	90.0	13000	100	0.24
421SN-5	8	5/16	-5	7.9	15.0	21.5	3125	86.0	12500	115	0.27
421SN-6	10	3/8	-6	9.5	17.4	18.0	2600	72.0	10400	130	0.34
421SN-8	12	1/2	-8	12.7	20.7	16.0	2325	64.0	9300	180	0.43
421SN-10	16	5/8	-10	15.9	23.9	13.0	1875	52.0	7500	200	0.49
421SN-12	20	3/4	-12	19.1	27.8	10.5	1525	42.0	6100	240	0.63
421SN-16	25	1	-16	25.4	35.8	8.8	1275	35.0	5075	300	0.94
421SN-20	32	1-1/4	-20	31.8	44.8	6.3	900	25.2	3600	420	1.19
421SN-24	40	1-1/2	-24	38.1	51.1	5.0	725	20.0	2900	500	1.49
421SN-32	50	2	-32	50.8	64.7	4.0	575	16.0	2300	630	2.23

The combination of high temperature and high pressure could reduce the hose life.

# 421WC

*No-Skive*

Galvanised steel wire cover



- *No-Skive* thin cover hose construction
- Metal and glass hot-spot resistance

## Primary Applications

Machine tool and glass industry

## Applicable Specifications

SAE 100 R1AT

## Construction

Tube: Synthetic rubber  
Reinforcement: One high-tensile steel wire braid  
Cover: Galvanized steel wire

Temperature Range ..... -40 °C up to +125 °C

Exception: Air ..... max. +70 °C

Water ..... max. +85 °C

## Recommended Fluids

Petroleum and water-glycol based fluids, lubricating oils, air and water.

Consult the chemical compatibility section on pages **Ab-22** to **Ab-30** for more detailed information.

## Fitting Series



- Available as complete hose assembly
- Parker 43 series fittings are compatible with this hose type and are available only on request

Part Number	Hose I.D.				Hose O.D. mm	Pressure Rating				min. bend radius mm	weight kg
	DN	Inch	Size	mm		max. working pressure		min. burst pressure			
						MPa	psi	MPa	psi		
421WC-4	6	1/4	-4	6.3	15.0	19.0	2750	76.0	11000	100	0.38
421WC-6	10	3/8	-6	9.5	19.0	15.5	2250	62.0	9000	130	0.54
421WC-8	12	1/2	-8	12.7	22.0	13.8	2000	55.0	8000	180	0.67
421WC-12	20	3/4	-12	19.1	29.0	8.6	1250	35.0	5075	240	0.95
421WC-16	25	1	-16	25.4	37.0	6.9	1000	28.0	4000	300	1.31

The combination of high temperature and high pressure could reduce the hose life.

# 422

**WORLDWIDE** *No-Skive*  
ISO 1436 1SN



- Meets ISO 1436
- Worldwide availability
- Worldwide consistent appearance, part number and functionality
- *No-Skive* thin cover hose construction
- Nitrile (NBR) inner tube  
– extended fluid compatibility

## Primary Applications

General medium pressure hydraulic applications

## Type Approvals

Details please find on pages **Ab-14** and **Ab-15**

## Applicable Specifications

ISO 1436 – DIN EN 853 1SN – SAE 100R1AT

## Construction

Tube: Nitrile (NBR)  
Reinforcement: One high-tensile steel wire braid  
Cover: Synthetic rubber

Temperature Range ..... -40 °C up to +100 °C

Exception: Air ..... max. +70 °C  
Water ..... max. +85 °C

## Recommended Fluids

Petroleum and water-glycol based fluids, lubricating oils, air and water. For air above 1.7 MPa, the hose cover must be pin-pricked.

Consult the chemical compatibility section on pages **Ab-22** to **Ab-30** for more detailed information.

## Fitting Series



Part Number	Hose I.D.				Hose O.D. mm	Pressure Rating				min. bend radius mm	weight kg
	DN	Inch	Size	mm		max. working pressure		min. burst pressure			
						MPa	psi	MPa	psi		
422-4	6	1/4	-4	6.3	13.4	22.5	3250	90.0	13000	100	0.24
422-5	8	5/16	-5	7.9	15.0	21.5	3125	86.0	12500	115	0.27
422-6	10	3/8	-6	9.5	17.4	18.0	2600	72.0	10400	130	0.34
422-8	12	1/2	-8	12.7	20.7	16.0	2325	64.0	9300	180	0.43
422-10	16	5/8	-10	15.9	23.9	13.0	1875	52.0	7500	200	0.49
422-12	20	3/4	-12	19.0	27.8	10.5	1525	42.0	6100	240	0.63
422-16	25	1	-16	25.4	35.8	8.8	1275	35.0	5075	300	0.94
422-20	32	1-1/4	-20	31.8	44.8	6.3	900	25.2	3600	420	1.19
422-24	40	1-1/2	-24	38.1	51.1	5.0	725	20.0	2900	500	1.49
422-32	50	2	-32	50.8	64.7	4.0	575	16.0	2300	630	2.23

The combination of high temperature and high pressure could reduce the hose life.

# 424

## No-Skive

Phosphate ester resistant hose

### Primary Applications

Aerospace, foundries, steel mills:  
Medium pressure hydraulic applications with phosphate ester fluids

### Applicable Specifications

Parker specification

### Restrictions

Do not allow tube to contact any petroleum base fluids.  
Use liquid soap as hose lubricant.

### Construction

Tube: EPDM synthetic rubber  
Reinforcement: One high-tensile steel wire braid  
Cover: Green EPDM synthetic rubber

Temperature Range ..... -40 °C up to +80 °C

Exception: Air ..... max. +70 °C  
Water, water glycol fluids .. max. +85 °C



- *No-Skive* thin cover hose construction
- SAE 100R1 pressure rating

### Recommended Fluids

Phosphate ester based hydraulic fluids, water-glycol based fluids, air and water.  
Consult the chemical compatibility section on pages **Ab-22** to **Ab-30** for more detailed information.

### Fitting Series



\*Available as complete hose assemblies with fittings series 43 for sizes -16 to -32 on request

Part Number	Hose I.D.				Hose O.D. mm	Pressure Rating				min. bend radius mm	weight kg
	DN	Inch	Size	mm		max. working pressure		min. burst pressure			
						MPa	psi	MPa	psi		
424-16	25	1	-16	25.4	36.0	6.9	1000	28.0	4000	300	0.94
424-20	32	1-1/4	-20	31.8	45.0	4.3	625	17.0	2500	420	1.19
424-24	40	1-1/2	-24	38.1	51.0	3.5	500	14.0	2000	500	1.49
424-32	50	2	-32	50.8	64.6	2.4	375	10.0	1500	630	2.23

The combination of high temperature and high pressure could reduce the hose life.



# 426

## No-Skive

SAE 100R1AT high temperature



- *No-Skive* thin cover hose construction
- SAE 100R1 pressure rating
- Ideal for high temperature applications

### Primary Applications

Medium pressure hydraulic applications at high temperature

### Type Approvals

Details please find on pages **Ab-14** and **Ab-15**

### Applicable Specifications

SAE 100 R1AT

### Construction

Tube: PKR synthetic rubber  
Reinforcement: One high-tensile steel wire braid  
Cover: Blue synthetic rubber

Temperature Range ..... -46 °C up to +150 °C

Exception: Air ..... max. +70 °C  
Water, water glycol fluids .. max. +85 °C

### Recommended Fluids

Petroleum hydraulic fluids, lubricating oils, water-glycol based fluids, air and water.

Consult the chemical compatibility section on pages **Ab-22** to **Ab-30** for more detailed information.

### Fitting Series



Part Number	Hose I.D.				Hose O.D. mm	Pressure Rating				min. bend radius mm	weight kg
	DN	Inch	Size	mm		max. working pressure		min. burst pressure			
						MPa	psi	MPa	psi		
426-4-RL	6	1/4	-4	6.3	13.4	19.2	2750	77.0	11000	100	0.24
426-6-RL	10	3/8	-6	9.5	17.4	15.7	2250	63.0	9000	125	0.34
426-8-RL	12	1/2	-8	12.7	20.7	14.0	2000	56.0	8000	180	0.43
426-10-RL	16	5/8	-10	15.9	23.9	10.5	1500	42.0	6000	200	0.49
426-12-RL	20	3/4	-12	19.1	27.8	8.7	1250	35.0	5075	240	0.65
426-16-RL	25	1	-16	25.4	35.8	7.0	1000	28.0	4000	300	0.98
426-20	32	1-1/4	-20	31.8	45.0	4.3	625	17.2	2500	420	1.40
426-24	40	1-1/2	-24	38.1	51.0	3.5	500	14.0	2000	500	1.46
426-32	50	2	-32	50.8	64.0	2.6	375	10.4	1500	630	2.18

The combination of high temperature and high pressure could reduce the hose life.  
RL = only available on reels.

# 436

## No-Skive Compact

SAE 100R16 high temperature

### Primary Applications

Medium pressure hydraulic applications at high temperature

### Type Approvals

Details please find on pages **Ab-14** and **Ab-15**

### Applicable Specifications

SAE 100R16

### Construction

Tube: PKR synthetic rubber  
Reinforcement: Two high-tensile steel wire braids  
Cover: MSHA approved blue synthetic rubber

Temperature Range ..... -48 °C up to +150 °C

Exception: Air ..... max. +70 °C  
Water, water glycol fluids .. max. +85 °C

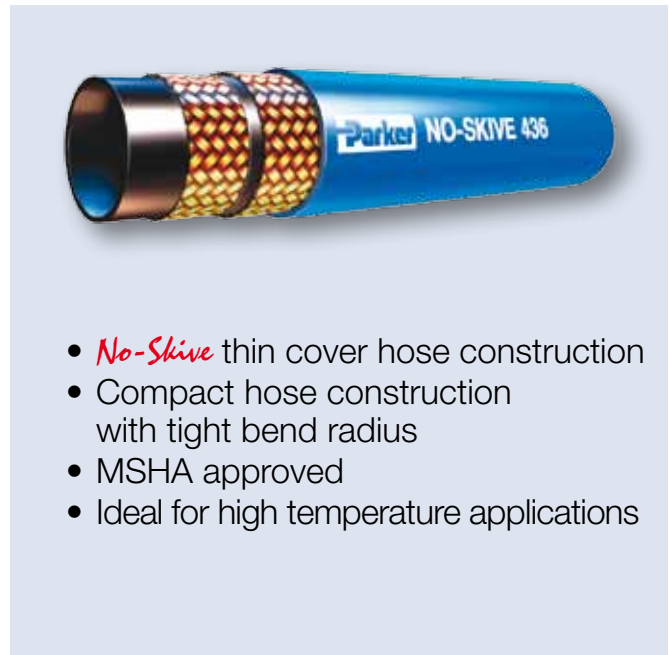

- *No-Skive* thin cover hose construction
- Compact hose construction with tight bend radius
- MSHA approved
- Ideal for high temperature applications

### Recommended Fluids

Petroleum hydraulic fluids, lubricating oils, water-glycol based fluids, air and water.

Consult the chemical compatibility section on pages **Ab-22** to **Ab-30** for more detailed information.

### Fitting Series



Part Number	Hose I.D.				Hose O.D. mm	Pressure Rating				min. bend radius mm	weight kg
	DN	Inch	Size	mm		max. working pressure		min. burst pressure			
						MPa	psi	MPa	psi		
436-6-BLU-RL	10	3/8	-6	9.5	17.0	27.5	4000	110.0	16000	65	0.42
436-8-BLU-RL	12	1/2	-8	12.7	20.0	24.0	3500	96.0	14000	90	0.51
436-10-BLU-RL	16	5/8	-10	15.9	24.0	19.0	2750	76.0	11000	100	0.66
436-12-BLU-RL	20	3/4	-12	19.1	28.0	15.5	2250	62.0	9000	120	0.80
436-16-BLU-RL	25	1	-16	25.4	36.0	13.8	2000	55.0	8000	150	1.22

The combination of high temperature and high pressure could reduce the hose life.  
RL = only available on reels.

# 441

## No-Skive

ISO 11237 Type R16 – SAE 100R16



- *No-Skive* hose construction
- One wire braid construction – two wire braid performance
- +125 °C working temperature
- Suitable with both 46 & 48 series fittings

### Primary Applications

Many industrial and mobile applications, with typical usage seen on agricultural machines or in power steering circuits

### Applicable Specifications

ISO 11237 Type R16 – SAE 100R16

### Construction

Tube: Synthetic rubber  
Reinforcement: One high-tensile steel wire braid  
Cover: Synthetic rubber

Temperature Range ..... -40 °C up to +125 °C

Exception: Air ..... max. +70 °C  
Water ..... max. +85 °C

### Recommended Fluids

Petroleum and water-glycol based fluids, lubricating oils, air and water. For air above 1.7 MPa, the hose cover must be pin-pricked.

Consult the chemical compatibility section on pages **Ab-22** to **Ab-30** for more detailed information.

### Fitting Series



Part Number	Hose I.D.				Hose O.D. mm	Pressure Rating				min. bend radius mm	weight kg
	DN	Inch	Size	mm		max. working pressure		min. burst pressure			
						MPa	psi	MPa	psi		
441-4	6	1/4	-4	6.3	13.4	35.0	5000	140.0	20000	50	0.27
441-5	8	5/16	-5	7.9	15.0	29.7	4250	118.8	17000	55	0.32
441-6	10	3/8	-6	9.5	17.4	28.0	4000	112.0	16000	65	0.42
441-8	12	1/2	-8	12.7	20.7	24.5	3500	98.0	14000	90	0.50
441-10	16	5/8	-10	15.9	23.8	19.2	2750	76.8	11000	100	0.65
441-12	20	3/4	-12	19.1	27.8	15.7	2250	62.8	9000	120	0.80
441-16	25	1	-16	25.4	35.8	14.0	2000	56.0	8000	150	1.22

The combination of high temperature and high pressure could reduce the hose life.  
Also available on reels up to size -12 under part number 441-xx-RL

# 441RH

## No-Skive Compact

Fire-retardant cover

### Primary Applications

General medium-pressure hydraulic and pneumatic systems as well as water and oil cooling circuits

### Type Approvals

Details please find on pages **Ab-14** and **Ab-15**

### Applicable Specifications

Parker specification; Working pressure to SAE 100R2;  
Bend radius to SAE 100R16

### Construction

Tube: Synthetic rubber  
Reinforcement: One high-tensile steel wire braid  
Cover: Fire retardant synthetic rubber

Temperature Range ..... -40 °C up to +125 °C

Exception: Air ..... max. +70 °C  
Water ..... max. +85 °C



- *No-Skive* hose construction
- One wire braid construction – two wire braid performance
- +125 °C working temperature
- Suitable with 46 & 48 series fittings
- Fire-retardant cover
- German Standard: **DIN 5510-2**
- French Standard: **NF F16-101/102 I2/F3**
- British Standard: **BS 6853 - Table 4**
- Italian Standard: **UNI CEI 11170**

### Recommended Fluids

Petroleum and water-glycol based fluids, lubricating oils, air and water. For air and gas above 1.7 MPa, the hose cover must be pin-pricked.

Consult the chemical compatibility section on pages **Ab-22** to **Ab-30** for more detailed information.

### Fitting Series



Part Number	Hose I.D.				Hose O.D. mm	Pressure Rating				min. bend radius mm	weight kg
	DN	Inch	Size	mm		max. working pressure		min. burst pressure			
						MPa	psi	MPa	psi		
441RH-4	6	1/4	-4	6.3	13.4	35.0	5000	140.0	20000	50	0.27
441RH-5	8	5/16	-5	7.9	15.0	29.7	4250	118.8	17000	55	0.32
441RH-6	10	3/8	-6	9.5	17.4	28.0	4000	112.0	16000	65	0.42
441RH-8	12	1/2	-8	12.7	20.7	24.5	3500	98.0	14000	90	0.50
441RH-10	16	5/8	-10	15.9	23.8	19.2	2750	76.8	11000	100	0.65
441RH-12	20	3/4	-12	19.1	27.8	15.7	2250	62.8	9000	120	0.80
441RH-16	25	1	-16	25.4	35.8	14.0	2000	56.0	8000	150	1.22

The combination of high temperature and high pressure could reduce the hose life.

# 451

*No-Skive*

ISO 11237 Type R17 – SAE 100R17



- *No-Skive* thin cover hose construction
- Constant working pressure of 21.0 Mpa
- Nitrile (NBR) inner tube – extended fluid compatibility

## Primary Applications

General medium pressure hydraulic applications

## Applicable Specifications

ISO 11237 Type R17 – SAE 100R17

## Construction

Tube: Nitrile (NBR)  
Reinforcement: One or two high-tensile steel wire braids  
Cover: Synthetic rubber

Temperature Range ..... -40 °C up to +100 °C

Exception: Air ..... max. +70 °C  
Water ..... max. +85 °C

## Recommended Fluids

Petroleum and water-glycol based fluids, lubricating oils, air and water. For air above 1.7 MPa, the hose cover must be pin-pricked.

Consult the chemical compatibility section on pages **Ab-22** to **Ab-30** for more detailed information.

## Fitting Series



Part Number	Hose I.D.				Hose O.D. mm	Pressure Rating				min. bend radius mm	weight kg
	DN	Inch	Size	mm		max. working pressure		min. burst pressure			
						MPa	psi	MPa	psi		
451-4	6	1/4	-4	6.3	13.4	21.0	3000	84.0	12000	50	0.24
451-6	10	3/8	-6	9.5	17.2	21.0	3000	84.0	12000	65	0.34
451-8	12	1/2	-8	12.7	20.4	21.0	3000	84.0	12000	90	0.52
451-10	16	5/8	-10	15.9	23.8	21.0	3000	84.0	12000	100	0.66
451-12	20	3/4	-12	19.1	27.8	21.0	3000	84.0	12000	120	0.86

The combination of high temperature and high pressure could reduce the hose life.

# 451TC

## No-Skive Tough Cover

ISO 11237 Type R17 – SAE 100R17

### Primary Applications

General medium pressure hydraulic applications where higher abrasion resistance is required.

### Type Approvals

Details please find on pages **Ab-14** and **Ab-15**

### Applicable Specifications

ISO 11237 Type R17 – SAE 100R17

### Construction

Tube: Nitrile (NBR)  
Reinforcement: One or two high-tensile steel wire braids  
Cover: MSHA approved synthetic rubber

Temperature Range ..... -40 °C up to +100 °C

Exception: Air ..... max. +70 °C

Water ..... max. +85 °C



- *No-Skive* thin cover hose construction
- Constant working pressure of 21.0 MPa
- Highly abrasion resistant **TOUGH COVER**
- MSHA approved
- Hose is suitable for temporary immersion in mineral oil up to 70 °C with frequent inspections
- Nitrile (NBR) inner tube – extended fluid compatibility

### Recommended Fluids

Petroleum and water-glycol based fluids, lubricating oils, air and water. For air above 1.7 MPa, the hose cover must be pin-pricked.

Consult the chemical compatibility section on pages **Ab-22** to **Ab-30** for more detailed information.

### Fitting Series



Part Number	Hose I.D.				Hose O.D. mm	Pressure Rating				min. bend radius mm	weight kg
	DN	Inch	Size	mm		max. working pressure		min. burst pressure			
						MPa	psi	MPa	psi		
451TC-4	6	1/4	-4	6.3	13.4	21.0	3000	84.0	12000	50	0.24
451TC-6	10	3/8	-6	9.5	17.2	21.0	3000	84.0	12000	65	0.34
451TC-8	12	1/2	-8	12.7	20.4	21.0	3000	84.0	12000	90	0.52
451TC-10	16	5/8	-10	15.9	23.8	21.0	3000	84.0	12000	100	0.66
451TC-12	20	3/4	-12	19.1	27.8	21.0	3000	84.0	12000	120	0.86
451TC-16	25	1	-16	25.4	35.4	21.0	3000	84.0	12000	150	1.17

Replace the hose when any deformation or damage on the hose cover are visible.  
The combination of high temperature and high pressure could reduce the hose life.  
Also available on reels under part number 451-xx-RL

# 461LT

## Elite Compact

DIN EN 857 2SC low temperature



- *No-Skive* thin cover hose construction
- Excellent ozone resistance
- Ideal for low temperature working conditions (-50 °C)

### Primary Applications

Mobile applications in low temperature environments:  
Forestry machines, refrigerated warehouses

### Applicable Specifications

DIN EN 857 2SC

### Construction

Tube: Synthetic rubber  
Reinforcement: Two high-tensile steel wire braids  
Cover: Synthetic rubber

Temperature Range ..... -50 °C up to +100 °C

Exception: Air ..... max. +70 °C  
Water ..... max. +85 °C

### Recommended Fluids

Petroleum and water-glycol based fluids, lubricating oils, air and water. For air above 1.7 MPa, the hose cover must be pin-pricked.

Consult the chemical compatibility section on pages **Ab-22** to **Ab-30** for more detailed information.

### Fitting Series



Part Number	Hose I.D.				Hose O.D. mm	Pressure Rating				min. bend radius mm	weight kg
	DN	Inch	Size	mm		max. working pressure		min. burst pressure			
						MPa	psi	MPa	psi		
461LT-4	6	1/4	-4	6.3	13	42.5	6160	170.0	24640	75	0.30
461LT-5	8	5/16	-5	7.9	15	40.0	5800	160.0	23200	85	0.35
461LT-6	10	3/8	-6	9.5	17	35.0	5075	140.0	20300	90	0.42
461LT-8	12	1/2	-8	12.7	21	31.0	4495	124.0	17980	130	0.52
461LT-10	16	5/8	-10	15.9	24	28.0	4060	112.0	16240	160	0.66
461LT-12	20	3/4	-12	19.1	28	28.0	4060	112.0	16240	195	0.86
461LT-16	25	1	-16	25.4	35	21.0	3045	84.0	12180	250	1.17

The combination of high temperature and high pressure could reduce the hose life.

# 462

## Elite Compact

DIN EN 857 2SC – ISO 11237 Type 2SC

### Primary Applications

Demanding medium pressure hydraulic applications in all markets

### Type Approvals

Details please find on pages **Ab-14** and **Ab-15**

### Applicable Specifications

DIN EN 857 2SC – ISO 11237 Type 2SC

### Construction

Tube: Nitrile (NBR)  
Reinforcement: Two high-tensile steel wire braids  
Cover: Synthetic rubber

Temperature Range ..... -40 °C up to +100 °C

Exception: Air ..... max. +70 °C

Water ..... max. +85 °C



- *No-Skive* hose construction  
– Compact design
- Nitrile (NBR) inner tube  
– extended fluid compatibility
- Exceeding EN/ISO specifications for pressure, bend radius and abrasion resistance

### Recommended Fluids

Petroleum and water-glycol based fluids, lubricating oils, air and water. For air above 1.7 MPa, the hose cover must be pin-pricked.

Consult the chemical compatibility section on pages **Ab-22** to **Ab-30** for more detailed information.

### Fitting Series



Part Number	Hose I.D.				Hose O.D. mm	Pressure Rating				min. bend radius mm	weight kg
	DN	Inch	Size	mm		max. working pressure		min. burst pressure			
						MPa	psi	MPa	psi		
462-4	6	1/4	-4	6.3	13.4	42.5	6160	170.0	24640	75	0.30
462-5	8	5/16	-5	7.9	15.0	40.0	5800	160.0	23200	85	0.35
462-6	10	3/8	-6	9.5	17.2	35.0	5075	140.0	20300	90	0.42
462-8	12	1/2	-8	12.7	20.4	31.0	4495	124.0	17980	130	0.52
462-10	16	5/8	-10	15.9	23.9	28.0	4060	112.0	16240	160	0.66
462-12	20	3/4	-12	19.1	27.7	28.0	4060	112.0	16240	195	0.86
462-16	25	1	-16	25.4	35.4	21.0	3045	84.0	12180	250	1.17
462-20-WR*	32	1-1/4	-20	31.8	43.0	17.2	2495	68.8	9980	335	1.50

Part Number without a suffix: the hose cover has a smooth appearance. Part Number with a suffix (WR): the hose cover has a wrapped appearance.

The combination of high temperature and high pressure could reduce the hose life.

Also available on reels under part number 462-xx-RL

\* only with fitting series 46



# 462ST

## Elite Super Tough Compact

DIN EN 857 2SC – ISO 11237 Type 2SC



- *No-Skive* hose construction  
– Compact design
- Nitrile (NBR) inner tube  
– extended fluid compatibility
- Extreme abrasion resistant  
**SUPER TOUGH** cover
- Exceeding EN/ISO specifications for pressure, bend radius and abrasion resistance

### Primary Applications

Mobile market: Medium pressure hydraulic applications with extremely high abrasion risks

### Applicable Specifications

DIN EN 857 2SC – ISO 11237 Type 2SC

### Construction

Tube: Nitrile (NBR)  
Reinforcement: Two high-tensile steel wire braids  
Cover: Synthetic rubber with a special polyethylene coating

Temperature Range ..... -40 °C up to +100 °C

Exception: Air ..... max. +70 °C  
Water ..... max. +85 °C

### Recommended Fluids

Petroleum and water-glycol based fluids, lubricating oils, air and water. For air above 1.7 MPa, the hose cover must be pin-pricked.

Consult the chemical compatibility section on pages **Ab-22** to **Ab-30** for more detailed information.

### Fitting Series



Part Number	Hose I.D.				Hose O.D. mm	Pressure Rating				min. bend radius mm	weight kg
	DN	Inch	Size	mm		max. working pressure		min. burst pressure			
						MPa	psi	MPa	psi		
462ST-4	6	1/4	-4	6.3	13.4	42.5	6500	170.0	24640	75	0.30
462ST-5	8	5/16	-5	7.9	15.0	40.0	5800	160.0	23200	85	0.35
462ST-6	10	3/8	-6	9.5	17.2	35.0	5075	140.0	20000	90	0.42
462ST-8	12	1/2	-8	12.7	20.4	31.0	4450	124.0	17800	125	0.52
462ST-10	16	5/8	-10	15.9	23.9	28.0	4000	112.0	16000	160	0.66
462ST-12	20	3/4	-12	19.1	27.7	28.0	4000	112.0	16000	195	0.86
462ST-16	25	1	-16	25.4	35.4	21.0	3000	84.0	12000	250	1.17
462ST-20*	32	1-1/4	-20	31.8	43.0	17.2	2495	68.8	9980	335	1.50

The combination of high temperature and high pressure could reduce the hose life.

\* only with fitting series 46

# 463

## No-Skive Compact

High pressure water cleaning applications



- 2 wire *No-Skive* Compact design
- For water up to +120 °C constant temperature
- Suitable with *No-Skive* 46 series fittings

### Primary Applications

High pressure water cleaners

### Construction

Tube: Synthetic rubber  
Reinforcement: Two high-tensile steel wire braids  
Cover: Synthetic rubber in black or blue colour

Temperature Range ..... water max. +120 °C

### Fitting Series



Part Number	Hose I.D.				Hose O.D.	Pressure Rating				min. bend radius mm	weight kg
	DN	Inch	Size	mm	mm	max. working pressure		min. burst pressure			
						MPa	psi	MPa	psi		
463-5	8	5/16	-5	7.9	15.0	40.0	5800	120.0	17400	75	0.31
463-5-BLU	8	5/16	-5	7.9	15.0	40.0	5800	120.0	17400	75	0.31
463-6	10	3/8	-6	9.5	17.4	40.0	5800	120.0	17400	90	0.38
463-6-BLU	10	3/8	-6	9.5	17.4	40.0	5800	120.0	17400	90	0.38
463-8	12	1/2	-8	12.7	20.6	35.0	5075	105.0	15225	110	0.48
463-8-BLU	12	1/2	-8	12.7	20.6	35.0	5075	105.0	15225	110	0.48

WKS rubber hand grip for No-Skive high pressure water cleaning hoses can be found on page **Eb-16**.  
The combination of high temperature and high pressure could reduce the hose life.  
Also available on reels under part number 463-xx-RL

## 471TC / 472TC

*No-Skive*

DIN EN 857 2SC – ISO 11237 Type 2SC

### Primary Applications

Small bending radii demanding medium pressure hydraulic applications

### Type Approvals

Details please find on pages **Ab-14** and **Ab-15**

### Applicable Specifications

DIN EN 857 2SC – ISO 11237 Type 2SC

### Construction

Tube 471TC: Synthetic rubber  
Tube 472TC: Nitrile (NBR)  
Reinforcement: Two high-tensile steel wire braids  
Cover: MSHA approved synthetic rubber

Temperature Range ..... -40 °C up to +100 °C

Exception: Air ..... max. +70 °C  
Water ..... max. +85 °C

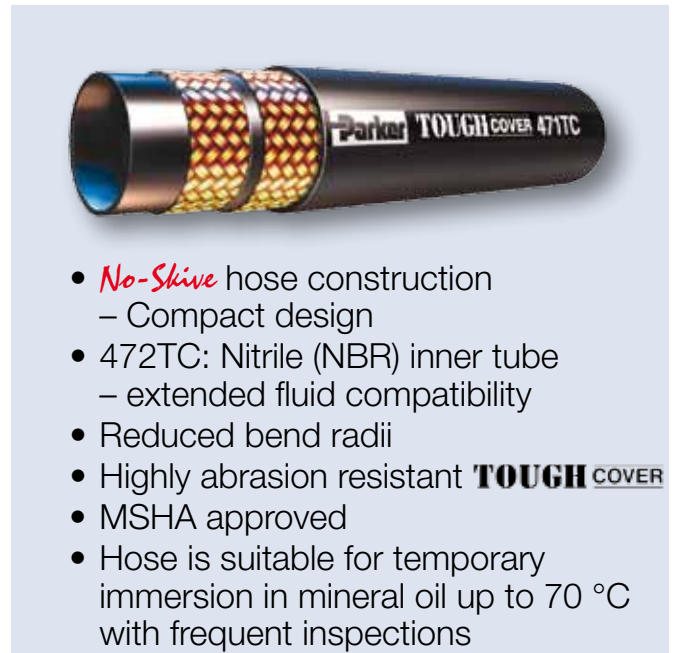

- *No-Skive* hose construction  
– Compact design
- 472TC: Nitrile (NBR) inner tube  
– extended fluid compatibility
- Reduced bend radii
- Highly abrasion resistant **TOUGH COVER**
- MSHA approved
- Hose is suitable for temporary immersion in mineral oil up to 70 °C with frequent inspections

### Recommended Fluids

Petroleum and water-glycol based fluids, lubricating oils, air and water. For air above 1.7 MPa, the hose cover must be pin-pricked.

Consult the chemical compatibility section on pages **Ab-22** to **Ab-30** for more detailed information.

### Fitting Series



Part Number	Hose I.D.				Hose O.D. mm	Pressure Rating				min. bend radius mm	weight kg
	DN	Inch	Size	mm		max. working pressure		min. burst pressure			
						MPa	psi	MPa	psi		
471TC-4	6	1/4	-4	6,3	13	40,0	5800	160,0	23200	50	0,30
471TC-5	8	5/16	-5	7,9	15	36,0	5250	144,0	21000	55	0,35
471TC-6	10	3/8	-6	9,5	17	35,0	5075	140,0	20000	65	0,42
471TC-8	12	1/2	-8	12,7	20	29,7	4250	119,0	17000	90	0,52
471TC-10	16	5/8	-10	15,9	24	25,0	3625	100,0	14500	100	0,66
471TC-12	20	3/4	-12	19,1	28	21,5	3125	86,0	12500	120	0,86
471TC-16	25	1	-16	25,4	35	17,5	2500	70,0	10000	150	1,17
472TC-20	32	1-1/4	-20	31,8	45	15,7	2250	63,0	9000	210	2,01
472TC-24	40	1-1/2	-24	38,1	51	12,5	1800	50,0	7200	250	2,16
472TC-32	50	2	-32	50,8	65	9,0	1300	36,0	5200	315	2,90

Replace the hose when any deformation or damages on the hose cover are visible.  
The combination of high temperature and high pressure could reduce the hose life.

# 477

## PowerLift *No-Skive*

2 wire braided

### Primary Applications

For truck cranes and lifting equipment such as fork lift trucks, aerial lifts, cranes, telehandlers, lifting platforms.

### Restrictions

Should not be used for high impulse hydraulic applications to replace spiral construction hoses.

### Construction

Tube: Nitrile (NBR)  
Reinforcement: Two high-tensile steel wire braids  
Cover: Synthetic rubber

Temperature Range ..... -40 °C up to +100 °C

Exception: Air ..... max. +70 °C

Water ..... max. +85 °C

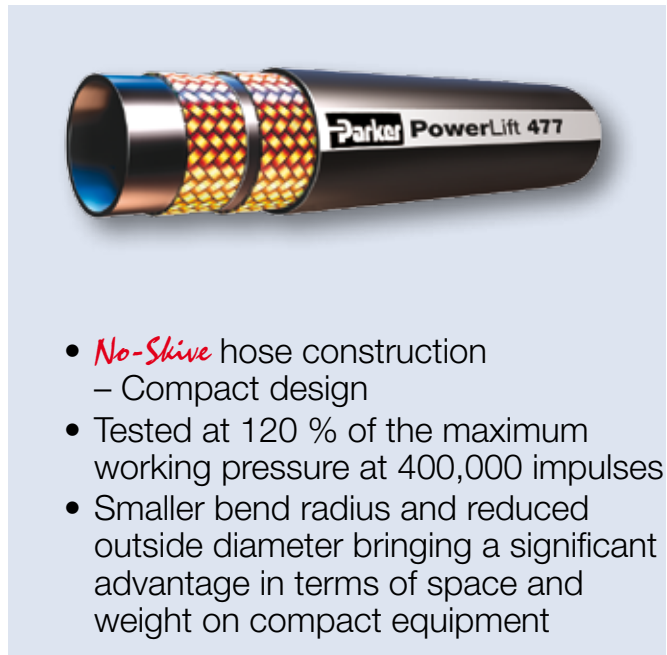

- *No-Skive* hose construction – Compact design
- Tested at 120 % of the maximum working pressure at 400,000 impulses
- Smaller bend radius and reduced outside diameter bringing a significant advantage in terms of space and weight on compact equipment

### Recommended Fluids

Petroleum and water-glycol based fluids, lubricating oils, air and water. For air above 1.7 MPa, the hose cover must be pin-pricked.

Consult the chemical compatibility section on pages **Ab-22** to **Ab-30** for more detailed information.

### Fitting Series



Part Number	Hose I.D.				Hose O.D. mm	Pressure Rating				min. bend radius mm	weight kg
	DN	Inch	Size	mm		max. working pressure		min. burst pressure			
						MPa	psi	MPa	psi		
477-4	6	1/4	-4	6.3	13.1	45.0	6500	180.0	26000	65	0.32
477-5	8	5/16	-5	7.9	14.9	42.5	6100	170.0	24400	70	0.35
477-6	10	3/8	-6	9.5	17.2	40.0	5800	160.0	23200	75	0.42
477-8	12	1/2	-8	12.7	20.4	38.0	5500	152.0	22000	105	0.55
477-10	16	5/8	-10	15.9	23.4	35.0	5000	140.0	20000	160	0.65
477-12	20	3/4	-12	19.1	27.2	35.0	5000	140.0	20000	200	1.10
477-16	25	1	-16	25.4	34.8	25.0	3600	100.0	14400	250	1.30

The combination of high temperature and high pressure could reduce the hose life.

# 477ST

## PowerLift *No-Skive*

2 wire braided

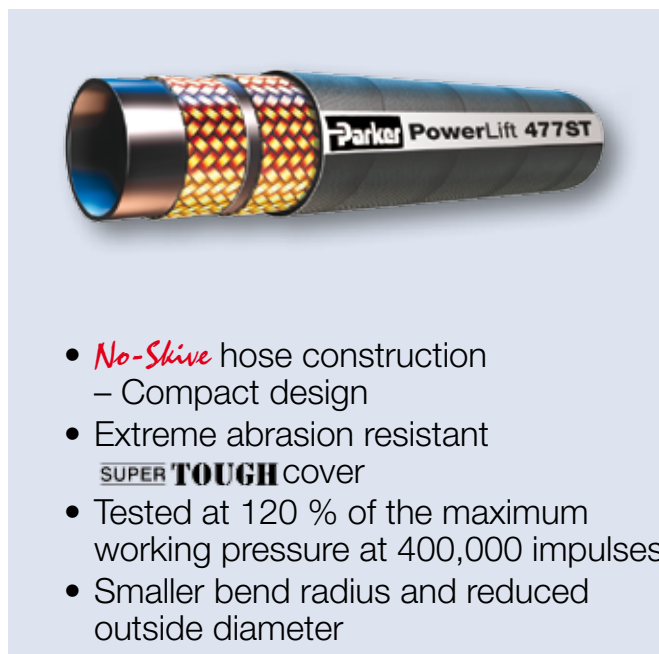

- *No-Skive* hose construction  
– Compact design
- Extreme abrasion resistant  
**SUPER TOUGH** cover
- Tested at 120 % of the maximum working pressure at 400,000 impulses
- Smaller bend radius and reduced outside diameter

### Primary Applications

For truck cranes and lifting equipment such as fork lift trucks, aerial lifts, cranes, telehandlers, lifting platforms.

### Restrictions

Should not be used for high impulse hydraulic applications to replace spiral construction hoses.

### Construction

Tube: Nitrile (NBR)  
Reinforcement: Two high-tensile steel wire braids  
Cover: Synthetic rubber

Temperature Range ..... -40 °C up to +100 °C

Exception: Air ..... max. +70 °C  
Water ..... max. +85 °C

### Recommended Fluids

Petroleum and water-glycol based fluids, lubricating oils, air and water. For air above 1.7 MPa, the hose cover must be pin-pricked.

Consult the chemical compatibility section on pages **Ab-22** to **Ab-30** for more detailed information.

### Fitting Series



Part Number	Hose I.D.				Hose O.D. mm	Pressure Rating				min. bend radius mm	weight kg
	DN	Inch	Size	mm		max. working pressure		min. burst pressure			
						MPa	psi	MPa	psi		
477ST-4	6	1/4	-4	6.3	13.1	45.0	6500	180.0	26000	75	0.30
477ST-5	8	5/16	-5	7.9	14.9	42.5	6100	170.0	24400	85	0.35
477ST-6	10	3/8	-6	9.5	17.2	40.0	5800	160.0	23200	90	0.42
477ST-8	12	1/2	-8	12.7	20.4	38.0	5500	152.0	22000	130	0.55
477ST-10	16	5/8	-10	15.9	23.4	35.0	5000	140.0	20000	250	0.65
477ST-12	20	3/4	-12	19.1	27.2	35.0	5000	140.0	20000	310	1.20
477ST-16	25	1	-16	25.4	34.8	25.0	3600	100.0	14400	250	1.30

The combination of high temperature and high pressure could reduce the hose life.

# 492

## Elite Compact

DIN EN 857 1SC – ISO 11237 Type 1SC

### Primary Applications

Demanding medium pressure hydraulic applications

### Type Approvals

Details please find on pages **Ab-14** and **Ab-15**

### Applicable Specifications

DIN EN 857 1SC – ISO 11237 Type 1SC

### Construction

Tube: Nitrile (NBR)  
Reinforcement: One high-tensile steel wire braid  
Cover: Synthetic rubber

Temperature Range ..... -40 °C up to +100 °C

Exception: Air ..... max. +70 °C  
Water ..... max. +85 °C



- *No-Skive* hose construction  
– Compact design
- Nitrile (NBR) inner tube  
– extended fluid compatibility
- Exceeding EN/ISO specifications for pressure, bend radius and abrasion resistance

### Recommended Fluids

Petroleum and water-glycol based fluids, lubricating oils, air and water. For air above 1.7 MPa, the hose cover must be pin-pricked.

Consult the chemical compatibility section on pages **Ab-22** to **Ab-30** for more detailed information.

### Fitting Series



Part Number	Hose I.D.				Hose O.D.	Pressure Rating				min. bend radius mm	weight kg
	DN	Inch	Size	mm	mm	max. working pressure		min. burst pressure			
						MPa	psi	MPa	psi		
492-4	6	1/4	-4	6.3	11.5	28.0	4060	112.0	16240	75	0.18
492-5	8	5/16	-5	7.9	13.6	25.0	3625	100.0	14500	85	0.21
492-6	10	3/8	-6	9.5	15.5	22.5	3260	90.0	13050	90	0.25
492-8	12	1/2	-8	12.7	18.9	19.0	2755	76.0	11020	130	0.33
492-10	16	5/8	-10	15.9	22.2	15.0	2175	60.0	8700	150	0.41
492-12	20	3/4	-12	19.1	26.0	15.0	2175	60.0	8700	180	0.56
492-16	25	1	-16	25.4	33.3	11.0	1595	44.0	6380	230	0.75
492-20-WR	32	1-1/4	-20	31.8	40.0	7.5	1085	30.0	4350	335	0.93

Part Number without a suffix: the hose cover has a smooth appearance. Part Number with a suffix (WR): the hose cover has a wrapped appearance.  
The combination of high temperature and high pressure could reduce the hose life.  
Also available on reels under part number 492-xx-RL

# 492ST

## Elite Super Tough Compact

DIN EN 857 1SC – ISO 11237 Type 1SC



- *No-Skive* hose construction  
– Compact design
- Nitrile (NBR) inner tube  
– extended fluid compatibility
- Extreme abrasion resistant  
**SUPER TOUGH** cover
- Exceeding EN/ISO specifications for pressure, bend radius and abrasion resistance

### Primary Applications

Mobile market: Medium pressure hydraulic applications with extremely high abrasion risks

### Applicable Specifications

DIN EN 857 1SC – ISO 11237 Type 1SC

### Construction

Tube: Nitrile (NBR)  
Reinforcement: One high-tensile steel wire braid  
Cover: Synthetic rubber with a special polyethylene coating

### Recommended Fluids

Petroleum and water-glycol based fluids, lubricating oils, air and water. For air above 1.7 MPa, the hose cover must be pin-pricked.

Consult the chemical compatibility section on pages **Ab-22** to **Ab-30** for more detailed information.

Temperature Range ..... -40 °C up to +100 °C

Exception: Air ..... max. +70 °C

Water ..... max. +85 °C

### Fitting Series



Part Number	Hose I.D.				Hose O.D. mm	Pressure Rating				min. bend radius mm	weight kg
	DN	Inch	Size	mm		max. working pressure		min. burst pressure			
						MPa	psi	MPa	psi		
492ST-4	6	1/4	-4	6.3	12.0	28.0	4000	112.0	16240	75	0.18
492ST-5	8	5/16	-5	7.9	13.6	25.0	3625	100.0	14500	85	0.21
492ST-6	10	3/8	-6	9.5	15.5	22.5	3260	90.0	13050	90	0.25
492ST-8	12	1/2	-8	12.7	18.9	19.0	2755	76.0	11020	130	0.33
492ST-10	16	5/8	-10	15.9	22.3	15.0	2175	60.0	8700	150	0.41
492ST-12	20	3/4	-12	19.1	26.0	15.0	2175	60.0	8700	180	0.56
492ST-16	25	1	-16	25.4	33.6	11.0	1595	44.0	6380	230	0.75
492ST-20	32	1-1/4	-20	31.8	40.0	7.5	1085	30.0	4350	335	0.93

The combination of high temperature and high pressure could reduce the hose life.

# 493

## No-Skive Compact

High pressure water cleaning applications



- One wire *No-Skive* construction
- For water up to +120 °C constant temperature
- Suitable with 48 series *No-Skive* fittings

### Primary Applications

High pressure water cleaners

### Construction

Tube: Synthetic rubber  
Reinforcement: One high-tensile steel wire braid  
Cover: Synthetic rubber in black or blue colour

Temperature Range ..... water max. +120 °C

### Fitting Series



Part Number	Hose I.D.				Hose O.D.	Pressure Rating				min. bend radius mm	weight kg
	DN	Inch	Size	mm	mm	max. working pressure		min. burst pressure			
						MPa	psi	MPa	psi		
493-4	6	1/4	-4	6.3	13.4	20.0	2898	60.0	8695	60	0.18
493-4-BLU	6	1/4	-4	6.3	13.4	20.0	2898	60.0	8695	60	0.18
493-5	8	5/16	-5	7.9	15.0	20.0	2898	60.0	8695	75	0.21
493-5-BLU	8	5/16	-5	7.9	15.0	20.0	2898	60.0	8695	75	0.21
493-6	10	3/8	-6	9.5	17.4	20.0	2898	60.0	8695	90	0.25
493-6-BLU	10	3/8	-6	9.5	17.4	20.0	2898	60.0	8695	90	0.25
493-8	12	1/2	-8	12.7	20.6	17.5	2536	52.5	7608	110	0.33
493-8-BLU	12	1/2	-8	12.7	20.6	17.5	2536	52.5	7608	110	0.33

WKS rubber hand grip for No-Skive high pressure water cleaning hoses can be found on page **Eb-16**.  
The combination of high temperature and high pressure could reduce the hose life.  
Also available on reels under part number 493-xx-RL



# 692

## Elite Compact

Constant pressure, tight bend radius

### Primary Applications

Material handling:

General small bending radii hydraulic applications, ideal for over the sheave or reel applications.

### Applicable Specifications

Parker specification

### Construction

Tube: Nitrile (NBR)

Reinforcement: One or two high-tensile steel wire braids

Cover: Synthetic rubber

Temperature Range ..... -40 °C up to +100 °C

Exception: Air ..... max. +70 °C



- *No-Skive* hose construction – Compact design
- Nitrile (NBR) inner tube – extended fluid compatibility
- Constant working pressure of 21.0 MPa

### Recommended Fluids

Petroleum and water-glycol based fluids, lubricating oils, air and water. For air above 1.7 MPa, the hose cover must be pin-pricked.

Consult the chemical compatibility section on pages **Ab-22** to **Ab-30** for more detailed information.

### Fitting Series



Part Number	Hose I.D.				Hose O.D. mm	Pressure Rating				min. bend radius mm	weight kg
	DN	Inch	Size	mm		max. working pressure		min. burst pressure			
						MPa	psi	MPa	psi		
692-4	6	1/4	-4	6.3	11.5	21.0	3045	84.0	12180	40	0.18
692-5	8	5/16	-5	7.9	13.6	21.0	3045	84.0	12180	40	0.21
692-6	10	3/8	-6	9.5	15.5	21.0	3045	84.0	12180	40	0.25
692-8	12	1/2	-8	12.7	20.4	21.0	3045	84.0	12180	50	0.52
692-10	16	5/8	-10	15.9	23.9	21.0	3045	84.0	12180	60	0.66

The combination of high temperature and high pressure could reduce the hose life.

# 692Twin

## Elite Compact

Twin constant pressure, tight bend radius

### Primary Applications

Lifting and material handling equipment:  
General small bending radii hydraulic applications, ideal over the sheave or reel applications

### Applicable Specifications

Parker specification

### Construction

Tube: Nitrile (NBR)  
Reinforcement: One or two high-tensile steel wire braids  
Cover: Synthetic rubber

Temperature Range ..... -40 °C up to +100 °C

Exception: Air ..... max. +70 °C



- *No-Skive* hose construction – Compact design
- Nitrile (NBR) inner tube – extended fluid compatibility
- Constant working pressure of 21.0 MPa

### Recommended Fluids

Petroleum and water-glycol based fluids, lubricating oils, air and water. For air above 1.7 MPa, the hose cover must be pin-pricked.

Consult the chemical compatibility section on pages **Ab-22** to **Ab-30** for more detailed information.

### Fitting Series



Part Number	Hose I.D.				Hose O.D. mm	Pressure Rating				min. bend radius mm	weight kg
	DN	Inch	Size	mm		max. working pressure		min. burst pressure			
						MPa	psi	MPa	psi		
692-4-4	6	1/4	-4	6.3	25.8	21.0	3045	84.0	12180	40	0.34
692-5-5	8	5/16	-5	7.9	27.4	21.0	3045	84.0	12180	40	0.40
692-6-6	10	3/8	-6	9.5	31.2	21.0	3045	84.0	12180	40	0.48
692-8-8	12	1/2	-8	12.7	41.5	21.0	3045	84.0	12180	50	1.02
692-10-10	16	5/8	-10	15.9	48.7	21.0	3045	84.0	12180	60	1.30

The combination of high temperature and high pressure could reduce the hose life.

# 811

## No-Skive Suction and Return Line

SAE 100R4



- *No-Skive* hose construction
- Helical wire to prevent collapse under vacuum
- Small bend radii

### Primary Applications

All Markets: General applications

### Construction

Tube: Synthetic rubber  
Reinforcement: Two fibre spiral, one helical wire  
Cover: Oil and weather resistant synthetic rubber

### Recommended Fluids

Petroleum and water-glycol based fluids, lubricating oils, air and water.

Consult the chemical compatibility section on pages **Ab-22** to **Ab-30** for more detailed information.

Temperature Range ..... -40 °C up to +100 °C

Exception: Air ..... max. +70 °C

Water ..... max. +85 °C

### Fitting Series

Up to size - 32

For size -40 and -48 fittings series on request



Part Number	Hose I.D.				Hose O.D. mm	Pressure Rating				Vacuum kilo Pascal *1 kPa	min. bend radius mm	weight kg
	DN	Inch	Size	mm		max. working pressure		min. burst pressure				
						MPa	psi	MPa	psi			
811-12**	20	3/4	-12	19.1	30.0	2.1	300	8.3	1200	85	65	0.63
811-16**	25	1	-16	25.4	38.0	1.7	250	6.9	1000	85	75	0.96
811-20	32	1-1/4	-20	31.8	45.0	1.4	200	5.5	800	85	100	1.22
811-24	40	1-1/2	-24	38.1	52.0	1.0	150	4.1	600	85	130	1.55
811-32	50	2	-32	50.8	64.0	0.7	100	2.8	400	85	150	1.87
811-40	62	2-1/2	-40	62.3	75.0	0.4	62	1.6	248	85	180	2.45
811-48	75	3	-48	74.6	90.0	0.4	62	1.6	248	85	230	3.20

\*1 = the vacuum values listed in the table are vacuum pressure values in kPa. For an absolute value subtract the table value from 101 kPa.

\*\* size -12 and size -16 = on Parkrimp 2 crimping press or adjustable crimpers only.  
The combination of high temperature and high pressure could reduce the hose life.

# 881

## No-Skive Suction and Return Line

SAE 100R4



- *No-Skive* hose construction
- Helical wire to prevent collapse under vacuum
- Up to +121 °C working temperature
- MSHA approved

### Primary Applications

All Markets: For high temperature applications  
For general applications

### Type Approvals

Details please find on pages **Ab-14** and **Ab-15**

### Construction

Tube: Synthetic rubber  
Reinforcement: Two fibre spiral, one helical wire  
Cover: Synthetic rubber MSHA approved

Temperature Range ..... -40 °C up to +121 °C

Exception: Air ..... max. +70 °C  
Water ..... max. +85 °C

### Recommended Fluids

Petroleum and water-glycol based fluids, lubricating oils, air and water.

Consult the chemical compatibility section on pages **Ab-22** to **Ab-30** for more detailed information.

### Fitting Series



Series 43 for sizes -12, -16

Series 48 for sizes -20 up to -32







For size -40 and -48 fittings series on request

Part Number	Hose I.D.				Hose O.D. mm	Pressure Rating				Vacuum kilo Pascal *1 kPa	min. bend radius mm	weight kg
	DN	Inch	Size	mm		max. working pressure		min. burst pressure				
						MPa	psi	MPa	psi			
881-12	20	3/4	-12	19.1	30.0	2.1	300	8.3	1200	95	130	0.74
881-16	25	1	-16	25.4	38.0	1.7	250	6.9	1000	95	150	0.89
881-20	32	1-1/4	-20	31.8	45.0	1.4	200	5.5	800	95	200	1.32
881-24	40	1-1/2	-24	38.1	52.0	1.0	150	4.1	600	95	250	1.65
881-32	50	2	-32	50.8	63.0	0.7	100	2.8	400	95	300	1.89
881-40	62	2-1/2	-40	62.3	75.0	0.4	62	1.6	248	95	355	2.71

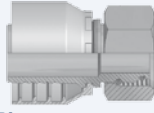

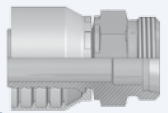
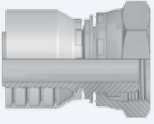
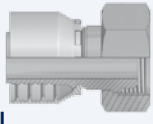

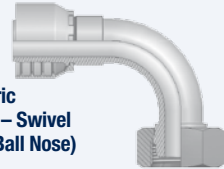
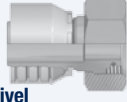
\*1 = the vacuum values listed in the table are vacuum pressure values in kPa. For an absolute value subtract the table value from 101kPa.  
The combination of high temperature and high pressure could reduce the hose life.

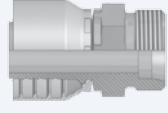
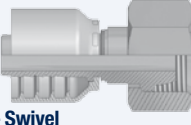
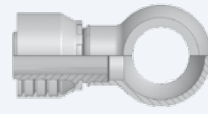



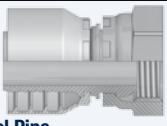

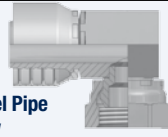
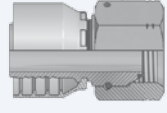

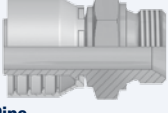
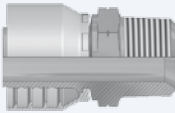
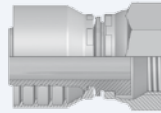
## DIN – Metric

Page Cb-1 – Cb-12			
<p><b>CA</b> Cb-1</p>  <p>Female Metric 24° Light Series with O-Ring Swivel – Straight ISO 12151-2-SWS-L – DKOL</p>	<p><b>CE</b> Cb-2</p>  <p>Female Metric 24° Light Series with O-Ring Swivel – 45° Elbow ISO 12151-2-SWE 45°-L – DKOL 45°</p>	<p><b>CF</b> Cb-3</p>  <p>Female Metric 24° Light Series with O-Ring Swivel – 90° Elbow ISO 12151-2-SWE-L – DKOL 90°</p>	<p><b>D0</b> Cb-4</p>  <p>Male Metric 24° Light Series – Rigid Straight ISO 12151-2-S-L – CEL</p>
<p><b>C0</b> Cb-4</p>  <p>Female Metric Very Light Series LL Swivel – Straight (Ball Nose) DKM</p>	<p><b>C3</b> Cb-5</p>  <p>Female Metric Light Series – Swivel Straight (Ball Nose) DKL</p>	<p><b>C4</b> Cb-5</p>  <p>Female Metric Light Series – Swivel 45° Elbow (Ball Nose) DKL 45°</p>	<p><b>C5</b> Cb-6</p>  <p>Female Metric Light Series – Swivel 90° Elbow (Ball Nose) DKL 90°</p>
<p><b>C9</b> Cb-7</p>  <p>Female Metric 24° – Swivel Heavy Series with O-Ring Straight ISO 12151-2-SWS-S – DKOS</p>	<p><b>0C</b> Cb-8</p>  <p>Female Metric 24° – Swivel Heavy Series with O-Ring 45° Elbow ISO 12151-2 – SWE 45°-S – DKOS 45°</p>	<p><b>1C</b> Cb-9</p>  <p>Female Metric 24° – Swivel Heavy Series with O-Ring 90° Elbow ISO 12151-2-SWE-S – DKOS 90°</p>	<p><b>D2</b> Cb-10</p>  <p>Male Metric 24° – Rigid Heavy Series – Straight ISO 12151-2-S-S – CES</p>
<p><b>C6</b> Cb-11</p>  <p>Female Metric – Swivel Heavy Series – Straight (Ball Nose) DKS</p>	<p><b>49</b> Cb-12</p>  <p>Metric Banjo Straight DIN 7642</p>		

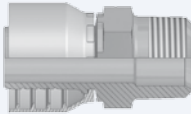
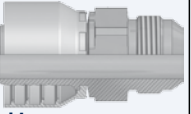
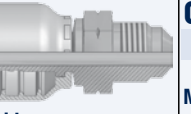
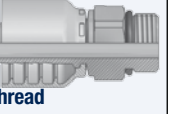
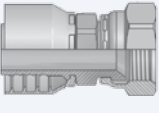
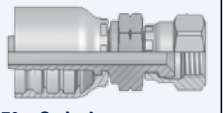

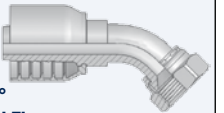

## BSP

Page Cb-13 – Cb-19			
<p><b>92</b> Cb-13</p>  <p>Female BSP Parallel Pipe Swivel – Straight (60° Cone) BS5200-A – DKR</p>	<p><b>B1</b> Cb-14</p>  <p>Female BSP Parallel Pipe Swivel 45° Elbow (60° Cone) BS 5200-D – DKR 45°</p>	<p><b>B2</b> Cb-15</p>  <p>Female BSP Parallel Pipe Swivel 90° Elbow (60° Cone) BS 5200-B – DKR 90°</p>	<p><b>B4</b> Cb-16</p>  <p>Female BSP Parallel Pipe Swivel – 90° Elbow Block Type (60° Cone) BS 5200-E – DKR 90°</p>
<p><b>EA</b> Cb-16</p>  <p>BSP Swivel Female with O-Ring (60° Cone) BS 5200 – ISO 12151-6 – DKOR</p>	<p><b>EB</b> Cb-17</p>  <p>BSP Swivel Female with O-Ring 45° Elbow (60° Cone) BS 5200 – ISO 12151-6 – DKOR 45°</p>	<p><b>EC</b> Cb-17</p>  <p>BSP Swivel Female with O-Ring 90° Elbow (60° Cone) BS 5200 – ISO 12151-6 – DKOR 90°</p>	<p><b>D9</b> Cb-18</p>  <p>Male BSP Parallel Pipe Rigid – Straight (60° Cone) BS5200 – AGR</p>
<p><b>91</b> Cb-19</p>  <p>Male BSP Taper Pipe – Rigid Straight BS5200 – AGR-K</p>	<p><b>B5</b> Cb-19</p>  <p>Female BSP Parallel Pipe Swivel Straight (Flat Seat)</p>		





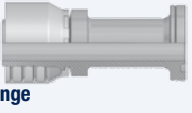

## SAE

Page Cb-20 – Cb-27			
<p><b>01</b> Cb-20</p>  <p>Male NPTF Pipe Rigid – Straight SAE J476A / J516 – AGN</p>	<p><b>03</b> Cb-21</p>  <p>Male JIC 37° – Rigid Straight ISO12151-5-S – AGJ</p>	<p><b>04</b> Cb-22</p>  <p>Male SAE 45° – Rigid Straight SAE J516</p>	<p><b>05</b> Cb-22</p>  <p>Male SAE Straight Thread with O-Ring – Rigid Straight ISO 11926 – SAE J516</p>
<p><b>06/68</b> Cb-23</p>  <p>Female – JIC 37° SAE 45° Dual Flare Swivel – Straight ISO12151-5-SWS – DKJ</p>	<p><b>08</b> Cb-24</p>  <p>Female SAE 45° – Swivel Straight SAE J516</p>	<p><b>33</b> Cb-24</p>  <p>Male JIC 37° – Rigid 45° Elbow ISO 12151-5 – AGJ 45°</p>	<p><b>37/3V</b> Cb-25</p>  <p>Female JIC 37° SAE 45° – Dual Flare Swivel Female 45° Elbow ISO 12151-5-SWE 45° – DKJ 45°</p>
<p><b>39/3W</b> Cb-26</p>  <p>Female JIC 37° SAE 45° – Dual Flare Swivel Female 90° Elbow ISO 12151-5-SWES – DKJ 90°</p>	<p><b>41/3Y</b> Cb-27</p>  <p>Female JIC 37° / 45° Swivel Female 90° Elbow (Long) ISO 12151-5-SWEL – DKJ 90°L</p>	<p><b>L9</b> Cb-27</p>  <p>Female JIC 37° – Swivel 90° Elbow – Medium Drop ISO 12151-5-SWEM – DKJ 90° M</p>	

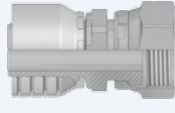
## Flange

Page Cb-28 – Cb-32			
<p><b>15</b> Cb-28</p>  <p>SAE Code 61 – Flange Head Straight ISO 12151-3-S-L – SFL 3000 psi</p>	<p><b>17</b> Cb-29</p>  <p>SAE Code 61 – Flange Head 45° Elbow ISO 12151-3 – E45 – L – SFL 45° 3000 psi</p>	<p><b>19</b> Cb-30</p>  <p>SAE Code 61 – Flange Head 90° Elbow ISO 12151-3 – E – L – SFL 90° 3000 psi</p>	<p><b>6A</b> Cb-31</p>  <p>SAE Code 62 Flange Straight ISO 12151-3-S-S – SFS 6000 psi</p>
<p><b>6F</b> Cb-31</p>  <p>SAE Code 62 Flange 45° Elbow – Heavy Series ISO 12151-3 – E45-S – SFS 45° 6000 psi</p>	<p><b>6N</b> Cb-32</p>  <p>SAE Code 62 Flange 90° Elbow ISO 12151-3 – E-S – SFS 90° 6000 psi</p>		

## ORFS

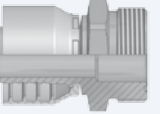
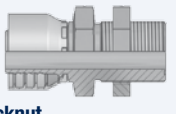

Page Cb-33 – Cb-38			
<p><b>JC</b> Cb-33</p>  <p>Female ORFS Swivel – Straight Short ISO 12151-1 – SWSA SAE J516 – ORFS</p>	<p><b>JS</b> Cb-34</p>  <p>ORFS Swivel Female (Long) ISO 12151-1-SWSB SAE J516 – ORFS</p>	<p><b>J7</b> Cb-35</p>  <p>Female ORFS – Swivel 45° Elbow ISO 12151-1 – SWE 45° SAE J516 – ORFS 45°</p>	<p><b>J9</b> Cb-36</p>  <p>Female ORFS – Swivel 90° Elbow – Short Drop ISO 12151-1 – SWS SAE J516 – ORFS 90°</p>
<p><b>J1</b> Cb-37</p>  <p>Female ORFS – Swivel 90° Elbow – Long Drop ISO 12151-1 – SWEL SAE J 516 – ORFS 90° L</p>	<p><b>J5</b> Cb-37</p>  <p>Female ORFS – Swivel 90° Elbow – Medium Drop ISO 12151-1 – SWEM – ORFS 90° M</p>	<p><b>JM</b> Cb-38</p>  <p>ORFS Male ISO 12151-1-S – SAE J516</p>	<p><b>JD</b> Cb-38</p>  <p>Male ORFS Bulkhead with Locknut Straight (with O-ring) ISO 12151-1 – SAE J516</p>

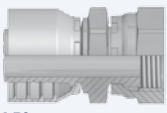
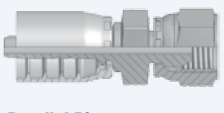
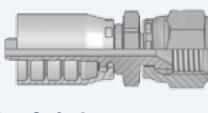
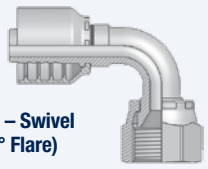

## JIS

Page Cb-39 – Cb-40			
<p><b>FU</b> Cb-39</p>  <p>Female BSP Parallel Pipe Swivel – Straight (30° Flare) ISO 228-1 – JIS B8363 – GUJ</p>	<p><b>GU</b> Cb-39</p>  <p>Female BSP Parallel Pipe Swivel – Straight (60° Cone) ISO 228-1 – JIS B8363 – GUO</p>	<p><b>MU</b> Cb-40</p>  <p>Female Metric – Swivel Straight (30° Flare) JIS B8363 – MU</p>	<p><b>MZ</b> Cb-40</p>  <p>Female Metric – Swivel 90° Elbow (30° Flare) JIS B8363</p>

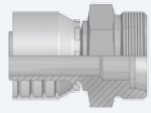
## French Standard

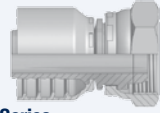
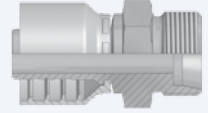
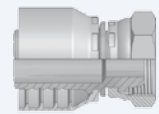
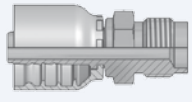
Page Cb-41 – Cb-43			
<p><b>FG</b> Cb-41</p>  <p>Male French Gas Series Rigid – Straight (24° Cone)</p>	<p><b>F2</b> Cb-41</p>  <p>Female French Gas Series Swivel – 90° Elbow</p>	<p><b>F4</b> Cb-42</p>  <p>Female French Gas Series Swivel – Straight (Ball Nose)</p>	<p><b>F6</b> Cb-42</p>  <p>French Male Metric Series (24° Cone)</p>
<p><b>F9</b> Cb-43</p>  <p>French Female Metric Series Swivel – (Ball Nose)</p>	<p><b>FA</b> Cb-43</p>  <p>Metric Male for Agriculture Valves</p>		

## High Pressure Cleaning

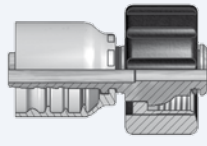
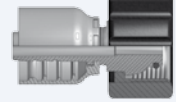
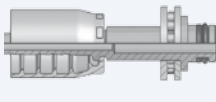
Page Cb-44 – Cb-45		
<p><b>CW</b> Cb-44</p>  <p>Power Cleaner Connection</p>	<p><b>NW</b> Cb-44</p>  <p>Female Kärcher Metric Cleaning Hose Fitting Swivel – Straight</p>	<p><b>PW</b> Cb-45</p>  <p>Male Kärcher Metric Cleaning Hose Fitting Rigid – Straight</p>

## Others

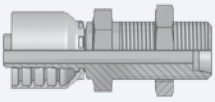
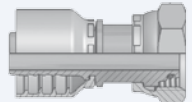
Page Cb-46	
<p><b>DK</b> Cb-46</p>  <p>Male Metric L – Rigid Bulkhead with Locknut (24° Cone)</p>	<p><b>DX</b> Cb-46</p>  <p>Female Metric Swivel (M27x2) O-Ring Light Series</p>

## UPTC Universal push-to-connect

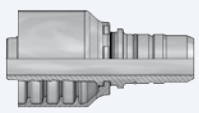
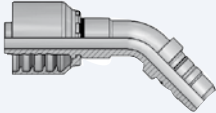
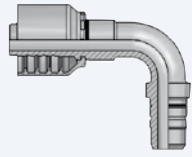
Page Cb-47 – Cb-48		
<p><b>EN</b> Cb-47</p>  <p>UPTC – Male Straight</p>	<p><b>EU</b> Cb-47</p>  <p>UPTC – Male 45° Elbow</p>	<p><b>ET</b> Cb-48</p>  <p>UPTC – Male 90° Elbow</p>



**CA** **Female Metric 24°  
Light Series with O-Ring  
Swivel – Straight**

ISO 12151-2-SWS-L – DKOL

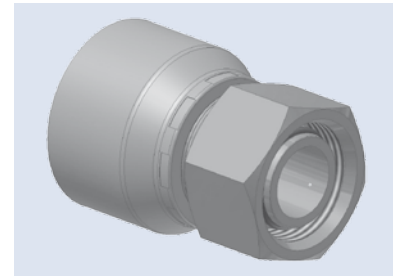
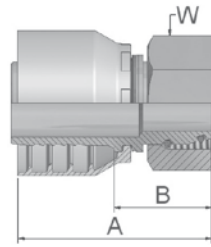

XXXXX-XX-XX Part Number		Hose I.D.				Thread metric	Tube O.D.	A	B	W
46	48	DN	Inch	Size	mm		mm	mm	mm	
1CA46-6-4	1CA48-6-4	6	1/4	-4	6.3	M12x1.5	6	46	22	14
1CA46-8-4	1CA48-8-4	6	1/4	-4	6.3	M14x1.5	8	46	22	17
1CA46-10-4	1CA48-10-4	6	1/4	-4	6.3	M16x1.5	10	46	22	19
1CA46-12-4	1CA48-12-4	6	1/4	-4	6.3	M18x1.5	12	46	22	22
1CA46-8-5	1CA48-8-5	8	5/16	-5	7.9	M14x1.5	8	50	26	17
1CA46-10-5	1CA48-10-5	8	5/16	-5	7.9	M16x1.5	10	46	22	19
1CA46-12-5	1CA48-12-5	8	5/16	-5	7.9	M18x1.5	12	46	22	22
1CA46-8-6	1CA48-8-6	10	3/8	-6	9.5	M14x1.5	8	49	26	17
1CA46-10-6	1CA48-10-6	10	3/8	-6	9.5	M16x1.5	10	46	23	19
1CA46-12-6	1CA48-12-6	10	3/8	-6	9.5	M18x1.5	12	46	23	22
1CA46-15-6	1CA48-15-6	10	3/8	-6	9.5	M22x1.5	15	47	24	27
1CA46-18-6	1CA48-18-6	10	3/8	-6	9.5	M26x1.5	18	50	28	32
1CA46-12-8	1CA48-12-8	12	1/2	-8	12.7	M18x1.5	12	50	26	22
1CA46-15-8	1CA48-15-8	12	1/2	-8	12.7	M22x1.5	15	50	26	27
1CA46-18-8	1CA48-18-8	12	1/2	-8	12.7	M26x1.5	18	49	25	32
1CA46-15-10	1CA48-15-10	16	5/8	-10	15.9	M22x1.5	15	54	29	27
1CA46-18-10	1CA48-18-10	16	5/8	-10	15.9	M26x1.5	18	50	25	32
1CA46-22-10	1CA48-22-10	16	5/8	-10	15.9	M30x2	22	58	33	36
1CA46-18-12	1CA48-18-12	20	3/4	-12	19.1	M26x1.5	18	51	25	32
1CA46-22-12	1CA48-22-12	20	3/4	-12	19.1	M30x2	22	56	30	36
1CA46-28-12	1CA48-28-12	20	3/4	-12	19.1	M36x2	28	61	35	41
1CA46-22-16	1CA48-22-16	25	1	-16	25.4	M30x2	22	60	30	36
1CA46-28-16	1CA48-28-16	25	1	-16	25.4	M36x2	28	63	33	41
1CA46-35-16	1CA48-35-16	25	1	-16	25.4	M45x2	35	63	33	50
	1CA48-28-20	32	1-1/4	-20	31.8	M36x2	28	81	34	41
1CA46-35-20		32	1-1/4	-20	31.8	M45x2	35	66	28	50
	1CA48-35-20	32	1-1/4	-20	31.8	M45x2	35	82	35	50
	1CA48-42-24	40	1-1/2	-24	38.1	M52x2	42	77	39	60

Hose fittings are delivered with ozone resistant Nitrile (NBR) O-ring as a standard version. Working temperature from -30 °C up to +105 °C.  
Hose fittings with special O-rings (Viton or EPDM) available on request. For O-ring dimensions and part-numbers see Section Eb.

Approved **fitting series** for hose types:

Also available in stainless steel. Details can be found in CAT 4400.1/UK

46	or	48	441	441RH	461LT	462	462ST													
46	463	492	492ST	692	692TWIN															
48	301SN	301TC	302	304	351TC	421RH	421SN	421WC	422	426	436	451	451TC	471TC	472TC	477	477ST	493	811	881

**CE** **Female Metric 24°  
Light Series with O-Ring  
Swivel – 45° Elbow**

ISO 12151-2-SWE 45°-L – DKOL 45°

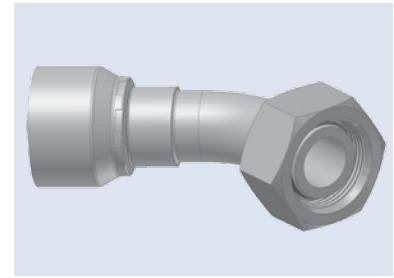
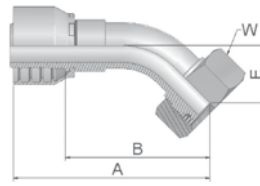

XXXXX-XX-XX Part Number		Hose I.D.				Thread metric	Tube O.D.	A	B	E	W
46	48	DN	Inch	Size	mm		mm	mm	mm	mm	mm
1CE46-6-4	1CE48-6-4	6	1/4	-4	6.3	M12x1.5	6	70	45	19	14
1CE46-8-4	1CE48-8-4	6	1/4	-4	6.3	M14x1.5	8	59	35	16	17
1CE46-10-4	1CE48-10-4	6	1/4	-4	6.3	M16x1.5	10	59	35	16	19
1CE46-12-4	1CE48-12-4	6	1/4	-4	6.3	M18x1.5	12	59	36	16	22
1CE46-8-5	1CE48-8-5	8	5/16	-5	7.9	M14x1.5	8	64	40	19	17
1CE46-10-5	1CE48-10-5	8	5/16	-5	7.9	M16x1.5	10	67	43	15	19
1CE46-12-5	1CE48-12-5	8	5/16	-5	7.9	M18x1.5	12	61	37	16	22
1CE46-10-6	1CE48-10-6	10	3/8	-6	9.5	M16x1.5	10	68	45	20	19
1CE46-12-6	1CE48-12-6	10	3/8	-6	9.5	M18x1.5	12	68	45	19	22
1CE46-15-6	1CE48-15-6	10	3/8	-6	9.5	M22x1.5	15	68	45	19	27
1CE46-12-8	1CE48-12-8	12	1/2	-8	12.7	M18x1.5	12	74	51	23	22
1CE46-15-8	1CE48-15-8	12	1/2	-8	12.7	M22x1.5	15	71	47	22	27
1CE46-18-8	1CE48-18-8	12	1/2	-8	12.7	M26x1.5	18	71	47	22	32
1CE46-15-10	1CE48-15-10	16	5/8	-10	15.9	M22x1.5	15	79	54	26	27
1CE46-18-10	1CE48-18-10	16	5/8	-10	15.9	M26x1.5	18	76	50	23	32
1CE46-18-12	1CE48-18-12	20	3/4	-12	19.1	M26x1.5	18	90	64	27	32
1CE46-22-12	1CE48-22-12	20	3/4	-12	19.1	M30x2	22	88	62	26	36
1CE46-28-12	1CE48-28-12	20	3/4	-12	19.1	M36x2	28	90	64	28	41
1CE46-22-16	1CE48-22-16	25	1	-16	25.4	M30x2	22	112	82	35	36
1CE46-28-16	1CE48-28-16	25	1	-16	25.4	M36x2	28	113	83	33	41
1CE46-35-20		32	1-1/4	-20	31.8	M45x2	35	130	92	38	50
	1CE48-35-20	32	1-1/4	-20	31.8	M45x2	35	141	94	38	50
	1CE48-42-24	40	1-1/2	-24	38.1	M52x2	42	155	117	49	60

Hose fittings are delivered with ozone resistant Nitrile (NBR) O-ring as a standard version. Working temperature from -30 °C up to +105 °C.  
Hose fittings with special O-rings (Viton or EPDM) available on request. For O-ring dimensions and part-numbers see Section Eb.

Approved **fitting series** for hose types:

Also available in stainless steel. Details can be found in CAT 4400.1/UK

46	or	48	441	441RH	461LT	462	462ST													
46	463	492	492ST	692	692TWIN															
48	301SN	301TC	302	304	351TC	421RH	421SN	421WC	422	426	436	451	451TC	471TC	472TC	477	477ST	493	811	881

**CF** **Female Metric 24°  
Light Series with O-Ring  
Swivel – 90° Elbow**

ISO 12151-2-SWE-L – DKOL 90°

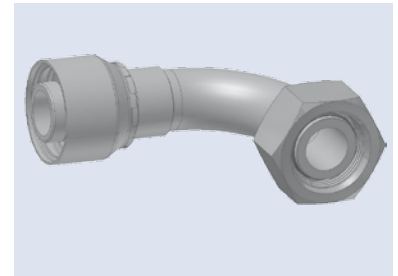
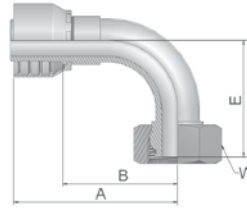

XXXXX-XX-XX Part Number		Hose I.D.				Thread metric	Tube O.D.	A	B	E	W
46	48	DN	Inch	Size	mm		mm	mm	mm	mm	
1CF46-6-4	1CF48-6-4	6	1/4	-4	6.3	M12x1.5	6	57	33	33	14
1CF46-8-4	1CF48-8-4	6	1/4	-4	6.3	M14x1.5	8	51	28	29	17
1CF46-10-4	1CF48-10-4	6	1/4	-4	6.3	M16x1.5	10	52	28	29	19
1CF46-12-4	1CF48-12-4	6	1/4	-4	6.3	M18x1.5	12	53	26	29	22
1CF46-8-5	1CF48-8-5	8	5/16	-5	7.9	M14x1.5	8	62	38	34	17
1CF46-10-5	1CF48-10-5	8	5/16	-5	7.9	M16x1.5	10	61	37	29	19
1CF46-12-5	1CF48-12-5	8	5/16	-5	7.9	M18x1.5	12	61	37	30	22
1CF46-10-6	1CF48-10-6	10	3/8	-6	9.5	M16x1.5	10	60	37	37	19
1CF46-12-6	1CF48-12-6	10	3/8	-6	9.5	M18x1.5	12	58	35	36	22
1CF46-15-6	1CF48-15-6	10	3/8	-6	9.5	M22x1.5	15	58	35	36	27
1CF46-12-8	1CF48-12-8	12	1/2	-8	12.7	M18x1.5	12	63	39	45	22
1CF46-15-8	1CF48-15-8	12	1/2	-8	12.7	M22x1.5	15	61	37	43	27
1CF46-18-8	1CF48-18-8	12	1/2	-8	12.7	M26x1.5	18	65	41	43	32
1CF46-15-10	1CF48-15-10	16	5/8	-10	15.9	M22x1.5	15	67	42	50	27
1CF46-18-10	1CF48-18-10	16	5/8	-10	15.9	M26x1.5	18	66	41	45	32
1CF46-22-10	1CF48-22-10	16	5/8	-10	15.9	M30x2	22	71	46	47	36
1CF46-18-12	1CF48-18-12	20	3/4	-12	19.1	M26x1.5	18	80	54	56	32
1CF46-22-12	1CF48-22-12	20	3/4	-12	19.1	M30x2	22	80	54	55	36
1CF46-28-12	1CF48-28-12	20	3/4	-12	19.1	M36x2	28	80	54	57	41
1CF46-22-16	1CF48-22-16	25	1	-16	25.4	M30x2	22	102	72	74	36
1CF46-28-16	1CF48-28-16	25	1	-16	25.4	M36x2	28	101	72	71	41
1CF46-28-20		32	1-1/4	-20	31.8	M36x2	28	124	86	81	41
	1CF48-28-20	32	1-1/4	-20	31.8	M36x2	28	129	82	81	41
1CF46-35-20		32	1-1/4	-20	31.8	M45x2	35	124	86	79	50
	1CF48-35-20	32	1-1/4	-20	31.8	M45x2	35	130	83	79	50
	1CF48-42-24	40	1-1/2	-24	38.1	M52x2	42	139	101	101	60

Hose fittings are delivered with ozone resistant Nitrile (NBR) O-ring as a standard version. Working temperature from -30 °C up to +105 °C. Hose fittings with special O-rings (Viton or EPDM) available on request. For O-ring dimensions and part-numbers see Section Eb.

Approved **fitting series** for hose types:

Also available in stainless steel. Details can be found in CAT 4400.1/UK

46	or	48	441	441RH	461LT	462	462ST													
46	463	492	492ST	692	692TWIN															
48	301SN	301TC	302	304	351TC	421RH	421SN	421WC	422	426	436	451	451TC	471TC	472TC	477	477ST	493	811	881

## D0 Male Metric 24° Light Series – Rigid Straight

ISO 12151-2-S-L – CEL

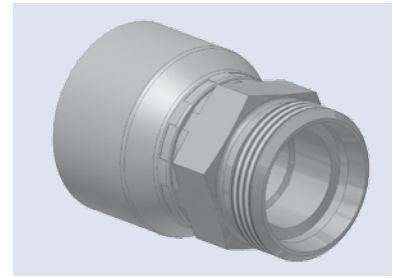
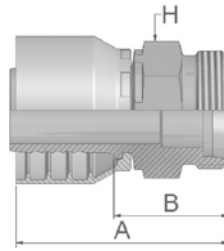

XXXXX-XX-XX Part Number		Hose I.D.				Thread metric	Tube O.D. mm	A mm	B mm	H mm
46	48	DN	Inch	Size	mm					
1D046-6-4	1D048-6-4	6	1/4	-4	6.3	M12x1.5	6	44	20	12
1D046-8-4	1D048-8-4	6	1/4	-4	6.3	M14x1.5	8	46	22	14
1D046-10-4	1D048-10-4	6	1/4	-4	6.3	M16x1.5	10	48	24	17
1D046-12-4	1D048-12-4	6	1/4	-4	6.3	M18x1.5	12	48	24	19
1D046-8-5	1D048-8-5	8	5/16	-5	7.9	M14x1.5	8	44	20	14
1D046-10-5	1D048-10-5	8	5/16	-5	7.9	M16x1.5	10	48	24	17
1D046-12-5	1D048-12-5	8	5/16	-5	7.9	M18x1.5	12	48	24	19
1D046-10-6	1D048-10-6	10	3/8	-6	9.5	M16x1.5	10	47	24	17
1D046-12-6	1D048-12-6	10	3/8	-6	9.5	M18x1.5	12	47	24	19
1D046-15-6	1D048-15-6	10	3/8	-6	9.5	M22x1.5	15	49	26	22
1D046-12-8	1D046-12-8	12	1/2	-8	12.7	M18x1.5	12	47	23	19
1D046-15-8	1D048-15-8	12	1/2	-8	12.7	M22x1.5	15	50	26	22
1D046-18-8	1D048-18-8	12	1/2	-8	12.7	M26x1.5	18	53	29	27
1D046-15-10	1D048-15-10	16	5/8	-10	15.9	M22x1.5	15	57	29	27
1D046-18-10	1D048-18-10	16	5/8	-10	15.9	M26x1.5	18	54	29	27
1D046-18-12	1D048-18-12	20	3/4	-12	19.1	M26x1.5	18	55	29	27
1D046-22-12	1D048-22-12	20	3/4	-12	19.1	M30x2	22	59	33	30
1D046-28-12	1D048-28-12	20	3/4	-12	19.1	M36x2	28	60	34	36
1D046-28-16	1D048-28-16	25	1	-16	25.4	M36x2	28	65	35	36
1D046-35-20		32	1-1/4	-20	31.8	M45x2	35	78	40	46
	1D048-35-20	32	1-1/4	-20	31.8	M45x2	35	85	38	46
	1D048-42-24	40	1-1/2	-24	38.1	M52x2	42	77	39	55

## C0 Female Metric Very Light Series LL Swivel – Straight (Ball Nose)

DKM

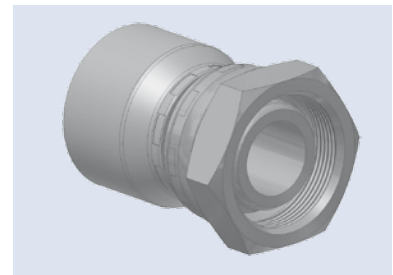
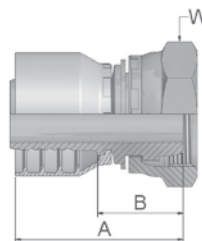

XXXXX-XX-XX Part Number		Hose I.D.				Thread metric	Tube O.D. mm	A mm	B mm	W mm
46	48	DN	Inch	Size	mm					
1C046-20-12	1C048-20-12	20	3/4	-12	19.1	M30x1.5	22	54	28	36
1C046-25-12	1C048-25-12	20	3/4	-12	19.1	M38x1.5	28	58	32	46
1C046-25-16	1C048-25-16	25	1	-16	25.4	M38x1.5	28	61	32	46
	1C048-32-20	32	1-1/4	-20	31.8	M45x1.5	35	78	31	55
	1C048-42-24	40	1-1/2	-24	38.1	M52x1.5	42	77	39	60

Approved fitting series for hose types:

Also available in stainless steel. Details can be found in CAT 4400.1/UK

46 or 48 441 441RH 461LT 462 462ST

46 463 492 492ST 692 692TWIN

48 301SN 301TC 302 304 351TC 421RH 421SN 421WC 422 426 436 451 451TC 471TC 472TC 477 477ST 493 811 881

### C3 Female Metric Light Series – Swivel Straight (Ball Nose)

DKL

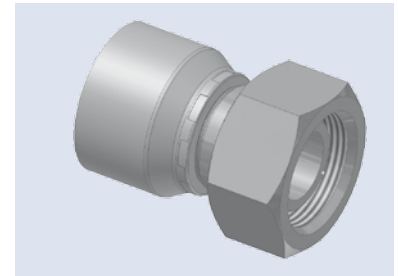
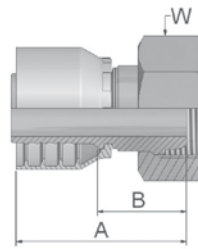

XXXXX-XX-XX Part Number		Hose I.D.				Thread metric	Tube O.D.	A	B	W
46	48	DN	Inch	Size	mm		mm	mm	mm	mm
1C346-6-4	1C348-6-4	6	1/4	-4	6.3	M12x1.5	6	46	22	14
1C346-8-4	1C348-8-4	6	1/4	-4	6.3	M14x1.5	8	45	21	17
1C346-10-4	1C348-10-4	6	1/4	-4	6.3	M16x1.5	10	46	22	19
1C346-10-5	1C348-10-5	8	5/16	-5	7.9	M16x1.5	10	46	22	19
1C346-12-5	1C348-12-5	8	5/16	-5	7.9	M18x1.5	12	46	22	22
1C346-10-6	1C348-10-6	10	3/8	-6	9.5	M16x1.5	10	47	24	19
1C346-12-6	1C348-12-6	10	3/8	-6	9.5	M18x1.5	12	45	22	22
1C346-15-8	1C348-15-8	12	1/2	-8	12.7	M22x1.5	15	48	24	27
1C346-15-10	1C348-15-10	16	5/8	-10	15.9	M22x1.5	15	52	27	27
1C346-18-10	1C348-18-10	16	5/8	-10	15.9	M26x1.5	18	51	26	32
1C346-22-12	1C348-22-12	20	3/4	-12	19.1	M30x2	22	56	30	36
1C346-28-16	1C348-28-16	25	1	-16	25.4	M36x2	28	62	33	41
1C346-35-20		32	1-1/4	-20	31.8	M45x2	35	62	24	50

### C4 Female Metric Light Series – Swivel 45° Elbow (Ball Nose)

DKL 45°

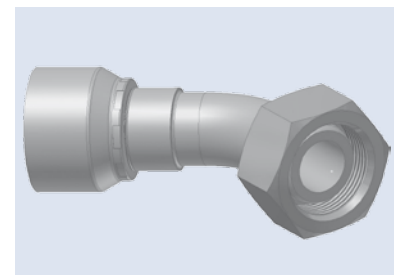
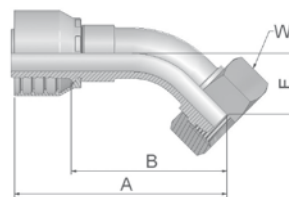

XXXXX-XX-XX Part Number		Hose I.D.				Thread metric	Tube O.D.	A	B	E	W
46	48	DN	Inch	Size	mm		mm	mm	mm	mm	mm
1C446-8-4	1C448-8-4	6	1/4	-4	6.3	M14x1.5	8	57	33	14	17
1C446-10-5	1C448-10-5	8	5/16	-5	7.9	M16x1.5	10	58	34	15	19
1C446-12-6	1C448-12-6	10	3/8	-6	9.5	M18x1.5	12	67	44	18	22
1C446-15-8	1C448-15-8	12	1/2	-8	12.7	M22x1.5	15	68	45	19	27

Approved fitting series for hose types:

Also available in stainless steel. Details can be found in CAT 4400.1/UK

46 or 48	441 441RH 461LT 462 462ST
46	463 492 492ST 692 692TWIN
48	301SN 301TC 302 304 351TC 421RH 421SN 421WC 422 426 436 451 451TC 471TC 472TC 477 477ST 493 811 881

# C5 Female Metric Light Series – Swivel 90° Elbow (Ball Nose)

DKL 90°

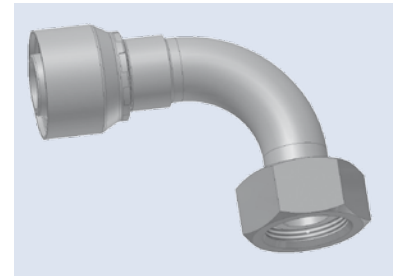
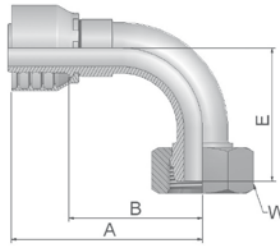

XXXXX-XX-XX Part Number		Hose I.D.				Thread metric	Tube O.D.	A	B	E	W
46	48	DN	Inch	Size	mm		mm	mm	mm	mm	
1C546-6-4	1C548-6-4	6	1/4	-4	6.3	M12x1.5	6	49	25	29	14
1C546-8-4	1C548-8-4	6	1/4	-4	6.3	M14x1.5	8	48	25	26	17
1C546-10-4	1C548-10-4	6	1/4	-4	6.3	M16x1.5	10	49	25	27	19
1C546-10-5	1C548-10-5	8	5/16	-5	7.9	M16x1.5	10	61	37	33	19
1C546-12-5	1C548-12-5	8	5/16	-5	7.9	M18x1.5	12	50	26	28	22
1C546-10-6	1C548-10-6	10	3/8	-6	9.5	M16x1.5	10	58	35	35	19
1C546-12-6	1C548-12-6	10	3/8	-6	9.5	M18x1.5	12	58	35	34	22
1C546-15-8	1C548-15-8	12	1/2	-8	12.7	M22x1.5	15	64	41	39	27
1C546-18-10	1C548-18-10	16	5/8	-10	15.9	M26x1.5	18	66	41	43	32
1C546-22-12	1C548-22-12	20	3/4	-12	19.1	M30x2	22	80	54	50	36
1C546-28-16	1C548-28-16	25	1	-16	25.4	M36x2	28	100	70	70	41

Approved **fitting series** for hose types:

Also available in stainless steel. Details can be found in CAT 4400.1/UK

46 or 48 441 441RH 461LT 462 462ST

46 463 492 492ST 692 692TWIN

48 301SN 301TC 302 304 351TC 421RH 421SN 421WC 422 426 436 451 451TC 471TC 472TC 477 477ST 493 811 881

# C9 Female Metric 24° – Swivel Heavy Series with O-Ring Straight

ISO 12151-2-SWS-S – DKOS

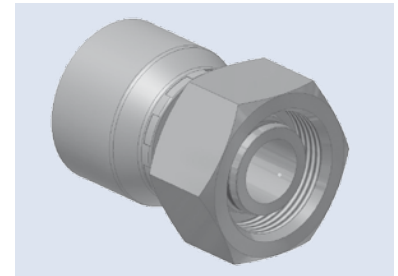
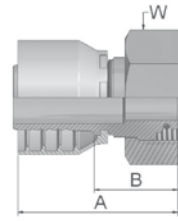

XXXXX-XX-XX Part Number		Hose I.D.				Thread metric	Tube O.D.	A	B	W
46	48	DN	Inch	Size	mm		mm	mm	mm	
1C946-6-4	1C948-6-4	6	1/4	-4	6.3	M14x1.5	6	49	26	17
1C946-8-4	1C948-8-4	6	1/4	-4	6.3	M16x1.5	8	47	23	19
1C946-10-4	1C948-10-4	6	1/4	-4	6.3	M18x1.5	10	46	22	22
1C946-12-4	1C948-12-4	6	1/4	-4	6.3	M20x1.5	12	47	24	24
1C946-14-4	1C948-14-4	6	1/4	-4	6.3	M22x1.5	14	48	24	27
1C946-8-5	1C948-8-5	8	5/16	-5	7.9	M16x1.5	8	46	23	19
1C946-10-5	1C948-10-5	8	5/16	-5	7.9	M18x1.5	10	46	22	22
1C946-12-5	1C948-12-5	8	5/16	-5	7.9	M20x1.5	12	48	24	24
1C946-14-5	1C948-14-5	8	5/16	-5	7.9	M22x1.5	14	48	24	27
1C946-16-5	1C948-16-5	8	5/16	-5	7.9	M24x1.5	16	52	28	30
1C946-8-6	1C948-8-6	10	3/8	-6	9.5	M16x1.5	8	49	26	19
1C946-10-6	1C948-10-6	10	3/8	-6	9.5	M18x1.5	10	45	23	22
1C946-12-6	1C948-12-6	10	3/8	-6	9.5	M20x1.5	12	47	24	24
1C946-14-6	1C948-14-6	10	3/8	-6	9.5	M22x1.5	14	47	24	27
1C946-16-6	1C948-16-6	10	3/8	-6	9.5	M24x1.5	16	50	28	30
1C946-12-8	1C948-12-8	12	1/2	-8	12.7	M20x1.5	12	51	28	24
1C946-14-8	1C948-14-8	12	1/2	-8	12.7	M22x1.5	14	48	24	27
1C946-16-8	1C948-16-8	12	1/2	-8	12.7	M24x1.5	16	51	28	30
1C946-20-8	1C948-20-8	12	1/2	-8	12.7	M30x2	20	53	29	36
1C946-16-10	1C948-16-10	16	5/8	-10	15.9	M24x1.5	16	53	28	30
1C946-20-10	1C948-20-10	16	5/8	-10	15.9	M30x2	20	53	28	36
1C946-20-12	1C948-20-12	20	3/4	-12	19.1	M30x2	20	56	30	36
1C946-25-12	1C948-25-12	20	3/4	-12	19.1	M36x2	25	61	35	46
1C946-25-16	1C948-25-16	25	1	-16	25.4	M36x2	25	63	33	46
1C946-30-16	1C948-30-16	25	1	-16	25.4	M42x2	30	67	38	50
1C946-38-20°		32	1-1/4	-20	31.8	M52x2	38	69	32	60
	1C948-38-20°	32	1-1/4	-20	31.8	M52x2	38	80	33	60

Hose fittings are delivered with ozone resistant Nitrile (NBR) O-ring as a standard version. Working temperature from -30 °C up to +105 °C.

Hose fittings with special O-rings (Viton or EPDM) available on request. For O-ring dimensions and part-numbers see Section Eb.

\*Assembly only with Parkrimp 2 machine

Approved fitting series for hose types:





Also available in stainless steel. Details can be found in CAT 4400.1/UK

46	or	48	441	441RH	461LT	462	462ST													
46	463	492	492ST	692	692TWIN															
48	301SN	301TC	302	304	351TC	421RH	421SN	421WC	422	426	436	451	451TC	471TC	472TC	477	477ST	493	811	881

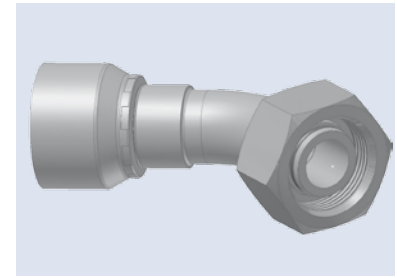
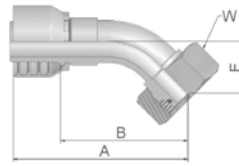
# OC Female Metric 24° – Swivel Heavy Series with O-Ring 45° Elbow

ISO 12151-2 – SWE 45°-S – DKOS 45°



XXXXX-XX-XX Part Number		 Hose I.D.				 Thread metric	 Tube O.D.	A	B	E	 W
46	48	DN	Inch	Size	mm		mm	mm	mm	mm	mm
10C46-6-4	10C48-6-4	6	1/4	-4	6.3	M14x1.5	6	61	37	17	17
10C46-8-4	10C48-8-4	6	1/4	-4	6.3	M16x1.5	8	59	35	16	19
10C46-10-4	10C48-10-4	6	1/4	-4	6.3	M18x1.5	10	59	36	16	22
10C46-12-4	10C48-12-4	6	1/4	-4	6.3	M20x1.5	12	72	48	17	24
10C46-10-5	10C48-10-5	8	5/16	-5	7.9	M18x1.5	10	62	38	17	22
10C46-12-5	10C48-12-5	8	5/16	-5	7.9	M20x1.5	12	71	47	17	24
10C46-10-6	10C48-10-6	10	3/8	-6	9.5	M18x1.5	10	70	47	19	22
10C46-12-6	10C48-12-6	10	3/8	-6	9.5	M20x1.5	12	69	46	20	24
10C46-14-6	10C48-14-6	10	3/8	-6	9.5	M22x1.5	14	69	46	20	27
10C46-14-8	10C48-14-8	12	1/2	-8	12.7	M22x1.5	14	70	46	22	27
10C46-16-8	10C48-16-8	12	1/2	-8	12.7	M24x1.5	16	72	49	23	30
10C46-16-10	10C48-16-10	16	5/8	-10	15.9	M24x1.5	16	78	52	24	30
10C46-20-10	10C48-20-10	16	5/8	-10	15.9	M30x2	20	76	51	25	36
10C46-20-12	10C48-20-12	20	3/4	-12	19.1	M30x2	20	93	64	28	36
10C46-25-12	10C48-25-12	20	3/4	-12	19.1	M36x2	25	91	65	29	46
10C46-25-16	10C48-25-16	25	1	-16	25.4	M36x2	30	110	80	33	46
10C46-30-16	10C48-30-16	25	1	-16	25.4	M42x2	30	116	86	36	50
10C46-38-20°		32	1-1/4	-20	31.8	M52x2	38	136	98	38	60
	10C48-38-20°	32	1-1/4	-20	31.8	M52x2	38	140	93	37	60

Hose fittings are delivered with ozone resistant Nitrile (NBR) O-ring as a standard version. Working temperature from -30 °C up to +105 °C. Hose fittings with special O-rings (Viton or EPDM) available on request. For O-ring dimensions and part-numbers see Section Eb.

°Assembly only with Parkrimp 2 machine

Approved **fitting series** for hose types:

Also available in stainless steel. Details can be found in CAT 4400.1/UK

**46** or **48** 441 441RH 461LT 462 462ST

**46** 463 492 492ST 692 692TWIN

**48** 301SN 301TC 302 304 351TC 421RH 421SN 421WC 422 426 436 451 451TC 471TC 472TC 477 477ST 493 811 881



# 1C Female Metric 24° – Swivel Heavy Series with O-Ring 90° Elbow

ISO 12151-2-SWE-S – DKOS 90°

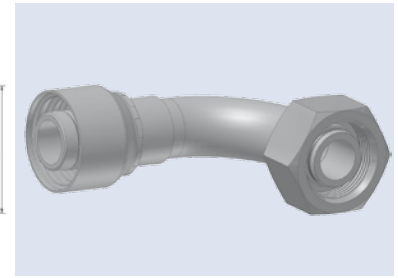
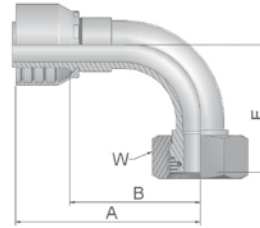

XXXXX-XX-XX Part Number		Hose I.D.				Thread metric	Tube O.D.	A	B	E	W
46	48	DN	Inch	Size	mm		mm	mm	mm	mm	
11C46-6-4	11C48-6-4	6	1/4	-4	6.3	M14x1.5	6	61	38	32	17
11C46-8-4	11C48-8-4	6	1/4	-4	6.3	M16x1.5	8	50	26	29	19
11C46-10-4	11C48-10-4	6	1/4	-4	6.3	M18x1.5	10	50	26	29	22
11C46-12-4	11C48-12-4	6	1/4	-4	6.3	M20x1.5	12	62	38	31	24
11C46-10-5	11C48-10-5	8	5/16	-5	7.9	M18x1.5	10	60	36	31	22
11C46-12-5	11C48-12-5	8	5/16	-5	7.9	M20x1.5	12	60	36	32	24
11C46-10-6	11C48-10-6	10	3/8	-6	9.5	M18x1.5	10	59	36	36	22
11C46-12-6	11C48-12-6	10	3/8	-6	9.5	M20x1.5	12	58	35	37	24
11C46-14-6	11C48-14-6	10	3/8	-6	9.5	M22x1.5	14	58	35	37	27
11C46-14-8	11C48-14-8	12	1/2	-8	12.7	M22x1.5	14	62	38	42	27
11C46-16-8	11C48-16-8	12	1/2	-8	12.7	M24x1.5	16	61	37	45	30
11C46-16-10	11C48-16-10	16	5/8	-10	15.9	M24x1.5	16	66	41	48	30
11C46-20-10	11C48-20-10	16	5/8	-10	15.9	M30x2	20	65	40	48	36
11C46-25-10	11C48-25-10	16	5/8	-10	15.9	M36x2	25	65	40	52	46
11C46-20-12	11C48-20-12	20	3/4	-12	19.1	M30x2	20	79	54	58	36
11C46-25-12	11C48-25-12	20	3/4	-12	19.1	M36x2	25	80	54	59	46
11C46-25-16	11C48-25-16	25	1	-16	25.4	M36x2	25	102	72	71	46
11C46-30-16	11C48-30-16	25	1	-16	25.4	M42x2	30	104	75	75	50
11C46-38-20°		32	1-1/4	-20	31.8	M52x2	38	124	86	80	60
	11C48-38-20°	32	1-1/4	-20	31.8	M52x2	38	130	83	78	60

Hose fittings are delivered with ozone resistant Nitrile (NBR) O-ring as a standard version. Working temperature from -30 °C up to +105 °C. Hose fittings with special O-rings (Viton or EPDM) available on request. For O-ring dimensions and part-numbers see Section Eb.

\*Assembly only with Parkrimp 2 machine

Approved **fitting series** for hose types:



Also available in stainless steel. Details can be found in CAT 4400.1/UK

46	or	48	441	441RH	461LT	462	462ST													
46	463	492	492ST	692	692TWIN															
48	301SN	301TC	302	304	351TC	421RH	421SN	421WC	422	426	436	451	451TC	471TC	472TC	477	477ST	493	811	881

## D2 Male Metric 24° – Rigid Heavy Series – Straight

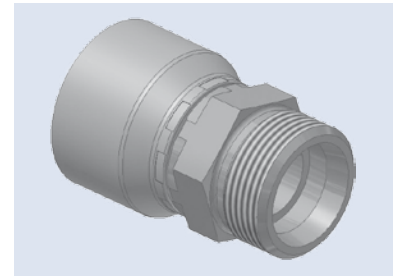
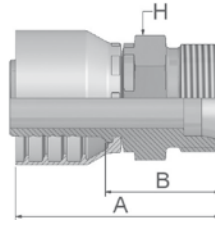
ISO 12151-2-S-S – CES

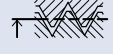

XXXXX-XX-XX Part Number		 Hose I.D.				 Thread metric	Tube O.D.	A	B	 H
46	48	DN	Inch	Size	mm		mm	mm	mm	mm
1D246-6-4	1D248-6-4	6	1/4	-4	6.3	M14x1.5	6	48	24	14
1D246-8-4	1D248-8-4	6	1/4	-4	6.3	M16x1.5	8	48	24	17
1D246-10-4	1D248-10-4	6	1/4	-4	6.3	M18x1.5	10	50	26	19
1D246-12-4	1D248-12-4	6	1/4	-4	6.3	M20x1.5	12	48	26	22
1D246-8-5	1D248-8-5	8	5/16	-5	7.9	M16x1.5	8	48	24	17
1D246-10-5	1D248-10-5	8	5/16	-5	7.9	M18x1.5	10	50	26	19
1D246-12-5	1D248-12-5	8	5/16	-5	7.9	M20x1.5	12	50	26	22
1D246-14-5	1D248-14-5	8	5/16	-5	7.9	M22x1.5	14	51	28	22
1D246-10-6	1D248-10-6	10	3/8	-6	9.5	M18x1.5	10	50	27	19
1D246-12-6	1D248-12-6	10	3/8	-6	9.5	M20x1.5	12	49	26	22
1D246-14-6	1D248-14-6	10	3/8	-6	9.5	M22x1.5	14	51	28	22
1D246-12-8	1D248-12-8	12	1/2	-8	12.7	M20x1.5	12	49	26	22
1D246-16-8	1D248-16-8	12	1/2	-8	12.7	M24x1.5	16	52	29	24
1D246-16-10	1D248-16-10	16	5/8	-10	15.9	M24x1.5	16	58	30	24
1D246-20-10	1D248-20-10	16	5/8	-10	15.9	M30x2	20	58	32	30
1D246-20-12	1D248-20-12	20	3/4	-12	19.1	M30x2	20	61	35	30
1D246-25-12	1D248-25-12	20	3/4	-12	19.1	M36x2	25	64	38	36
1D246-25-16	1D248-25-16	25	1	-16	25.4	M36x2	25	68	39	36
1D246-30-16	1D248-30-16	25	1	-16	25.4	M42x2	30	71	42	46
1D246-38-20		32	1-1/4	-20	31.8	M52x2	38	84	46	55
	1D248-38-20	32	1-1/4	-20	31.8	M52x2	38	91	44	55

Approved **fitting series** for hose types:

Also available in stainless steel. Details can be found in CAT 4400.1/UK

**46** or **48** 441 441RH 461LT 462 462ST

**46** 463 492 492ST 692 692TWIN

**48** 301SN 301TC 302 304 351TC 421RH 421SN 421WC 422 426 436 451 451TC 471TC 472TC 477 477ST 493 811 881

# C6 Female Metric – Swivel Heavy Series – Straight (Ball Nose)

DKS

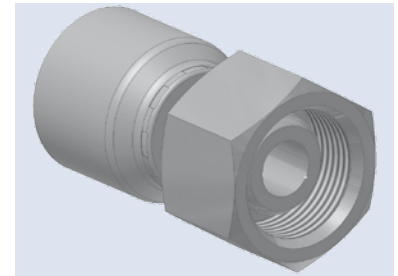
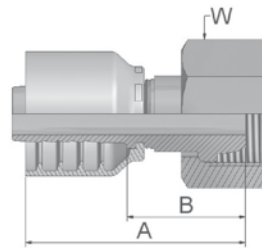

XXXXX-XX-XX Part Number		Hose I.D.				Thread metric	Tube O.D.	A	B	W
46	48	DN	Inch	Size	mm		mm	mm	mm	mm
1C646-8-4	1C648-8-4	6	1/4	-4	6.3	M16x1.5	8	46	23	19
1C646-10-4	1C648-10-4	6	1/4	-4	6.3	M18x1.5	10	46	22	22
1C646-12-5	1C648-12-5	8	5/16	-5	7.9	M20x1.5	12	49	25	24
1C646-12-6	1C648-12-6	10	3/8	-6	9.5	M20x1.5	12	48	25	24
1C646-14-6	1C648-14-6	10	3/8	-6	9.5	M22x1.5	14	47	24	27
1C646-16-8	1C648-16-8	12	1/2	-8	12.7	M24x1.5	16	51	28	30

Approved **fitting series** for hose types:

Also available in stainless steel. Details can be found in CAT 4400.1/UK

46	or	48	441	441RH	461LT	462	462ST													
46	463	492	492ST	692	692TWIN															
48	301SN	301TC	302	304	351TC	421RH	421SN	421WC	422	426	436	451	451TC	471TC	472TC	477	477ST	493	811	881

# 49 Metric Banjo Straight

DIN 7642

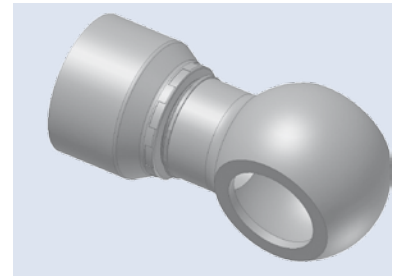
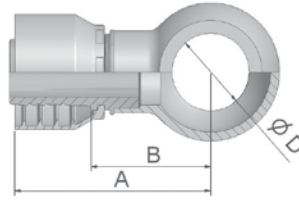

XXXXX-XX-XX Part Number		 Hose I.D.				A	B	D
46	48	DN	Inch	Size	mm	mm	mm	mm
14946-10-4	14948-10-4	6	1/4	-4	6.3	47	24	10
14946-12-4	14948-12-4	6	1/4	-4	6.3	50	26	12
14946-14-4	14948-14-4	6	1/4	-4	6.3	51	28	14
14946-14-5	14948-14-5	8	5/16	-5	7.9	51	28	14
14946-16-5	14948-16-5	8	5/16	-5	7.9	53	30	16
14946-16-6	14948-16-6	10	3/8	-6	9.5	53	30	16
14946-17-6	14948-17-6	10	3/8	-6	9.5	53	30	17
14946-18-6	14948-18-6	10	3/8	-6	9.5	55	32	18
14946-22-6	14948-22-6	10	3/8	-6	9.5	58	35	22
14946-18-8	14948-18-8	12	1/2	-8	12.7	56	32	18
14946-22-8	14948-22-8	12	1/2	-8	12.7	59	35	22
14946-22-10	14948-22-10	16	5/8	-10	15.9	60	35	22
14946-26-12	14948-26-12	20	3/4	-12	19.1	66	40	26
14946-27-12	14948-27-12	20	3/4	-12	19.1	66	40	27

To select corresponding screw and seals see section Eb.

Approved **fitting series** for hose types:

Also available in stainless steel. Details can be found in CAT 4400.1/UK

46 or 48	441 441RH 461LT 462 462ST
46	463 492 492ST 692 692TWIN
48	301SN 301TC 302 304 351TC 421RH 421SN 421WC 422 426 436 451 451TC 471TC 472TC 477 477ST 493 811 881

# 92 Female BSP Parallel Pipe Swivel – Straight (60° Cone)

BS5200-A – DKR

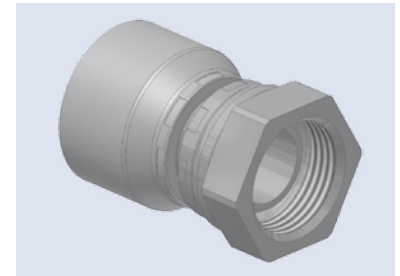
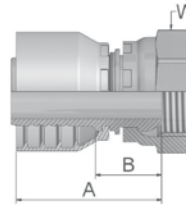

XXXXX-XX-XX Part Number		Hose I.D.				Thread BSP	A mm	B mm	W mm
46	48	DN	Inch	Size	mm				
19246-2-4	19248-2-4	6	1/4	-4	6.3	1/8x28	41	17	14
19246-4-4	19248-4-4	6	1/4	-4	6.3	1/4x19	46	19	19
19246-6-4	19248-6-4	6	1/4	-4	6.3	3/8x19	44	20	22
19246-8-4	19248-8-4	6	1/4	-4	6.3	1/2x14	49	25	27
19246-4-5	19248-4-5	8	5/16	-5	7.9	1/4x19	43	19	19
19246-6-5	19248-6-5	8	5/16	-5	7.9	3/8x19	44	20	22
19246-4-6	19248-4-6	10	3/8	-6	9.5	1/4x19	43	20	19
19246-6-6	19248-6-6	10	3/8	-6	9.5	3/8x19	43	20	22
19246-8-6	19248-8-6	10	3/8	-6	9.5	1/2x14	45	22	27
19246-6-8	19248-6-8	12	1/2	-8	12.7	3/8x19	45	21	22
19246-8-8	19248-8-8	12	1/2	-8	12.7	1/2x14	45	22	27
19246-10-8	19248-10-8	12	1/2	-8	12.7	5/8x14	44	21	30
19246-12-8	19248-12-8	12	1/2	-8	12.7	3/4x14	47	23	32
19246-8-10	19248-8-10	16	5/8	-10	15.9	1/2x14	48	22	27
19246-10-10	19248-10-10	16	5/8	-10	15.9	5/8x14	46	20	30
19246-12-10	19248-12-10	16	5/8	-10	15.9	3/4x14	47	22	32
19246-8-12	19248-8-12	20	3/4	-12	19.1	1/2x14	49	23	27
19246-10-12	19248-10-12	20	3/4	-12	19.1	5/8x14	48	22	30
19246-12-12	19248-12-12	20	3/4	-12	19.1	3/4x14	49	23	32
19246-16-12	19248-16-12	20	3/4	-12	19.1	1x11	51	25	41
19246-16-16	19248-16-16	25	1	-16	25.4	1x11	55	25	41
19246-20-16	19248-20-16	25	1	-16	25.4	1-1/4x11	63	31	50
19246-20-20		32	1-1/4	-20	31.8	1-1/4x11	68	31	50
	19248-20-20	32	1-1/4	-20	31.8	1-1/4x11	79	32	50
	19248-24-24	40	1-1/2	-24	38.1	1-1/2x11	71	33	60
	19248-32-32	50	2	-32	50.8	2x11	84	35	70

Approved fitting series for hose types:





Also available in stainless steel. Details can be found in CAT 4400.1/UK

46	or	48	441	441RH	461LT	462	462ST													
46	463	492	492ST	692	692TWIN															
48	301SN	301TC	302	304	351TC	421RH	421SN	421WC	422	426	436	451	451TC	471TC	472TC	477	477ST	493	811	881

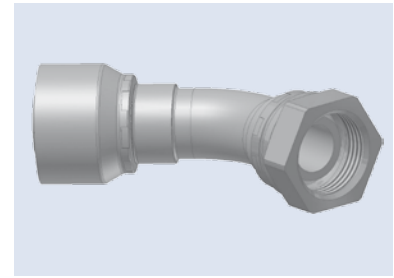
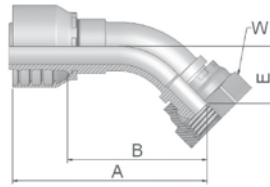
# B1 Female BSP Parallel Pipe Swivel 45° Elbow (60° Cone)

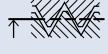

BS 5200-D – DKR 45°





XXXXX-XX-XX		 Hose I.D.				 Thread BSP	A	B	E	 W
Part Number		DN	Inch	Size	mm		mm	mm	mm	mm
 46	 48									
1B146-4-4	1B148-4-4	6	1/4	-4	6.3	1/4x19	59	35	16	19
1B146-6-4	1B148-6-4	6	1/4	-4	6.3	3/8x19	59	35	14	22
1B146-6-5	1B148-6-5	8	5/16	-5	7.9	3/8x19	60	36	15	22
1B146-6-6	1B148-6-6	10	3/8	-6	9.5	3/8x19	69	46	17	22
1B146-8-6	1B148-8-6	10	3/8	-6	9.5	1/2x14	63	40	17	27
1B146-6-8	1B148-6-8	12	1/2	-8	12.7	3/8x19	72	49	21	22
1B146-8-8	1B148-8-8	12	1/2	-8	12.7	1/2x14	72	48	20	27
1B146-10-8	1B148-10-8	12	1/2	-8	12.7	5/8x14	69	46	19	30
1B146-10-10	1B148-10-10	16	5/8	-10	15.9	5/8x14	77	52	22	30
1B146-12-10	1B148-12-10	16	5/8	-10	15.9	3/4x14	75	49	21	32
1B146-12-12	1B148-12-12	20	3/4	-12	19.1	3/4x14	87	61	25	32
1B146-16-12	1B148-16-12	20	3/4	-12	19.1	1x11	88	62	26	41
1B146-16-16	1B148-16-16	25	1	-16	25.4	1x11	106	76	31	41
1B146-20-20		32	1-1/4	-20	31.8	1-1/4x11	133	95	35	50
	1B148-20-20	32	1-1/4	-20	31.8	1-1/4x11	139	91	35	50
	1B148-24-24	40	1-1/2	-24	38.1	1-1/2x11	160	122	52	55
	1B148-32-32	50	2	-32	50.8	2x11	210	161	58	70

Approved **fitting series** for hose types:

Also available in stainless steel. Details can be found in CAT 4400.1/UK

 46 or  48 441 441RH 461LT 462 462ST

 46 463 492 492ST 692 692TWIN

 48 301SN 301TC 302 304 351TC 421RH 421SN 421WC 422 426 436 451 451TC 471TC 472TC 477 477ST 493 811 881

## B2 Female BSP Parallel Pipe Swivel 90° Elbow (60° Cone)

BS 5200-B – DKR 90°

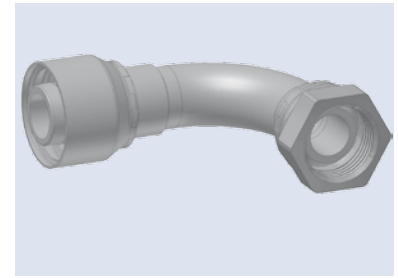
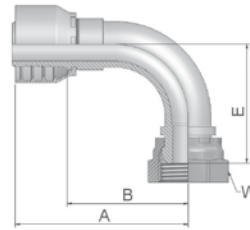

XXXXX-XX-XX Part Number		Hose I.D.				Thread BSP	A	B	E	W
46	48	DN	Inch	Size	mm		mm	mm	mm	mm
1B246-2-4	1B248-2-4	6	1/4	-4	6.3	1/8x28	50	26	30	14
1B246-4-4	1B248-4-4	6	1/4	-4	6.3	1/4x19	50	26	28	19
1B246-6-4	1B248-6-4	6	1/4	-4	6.3	3/8x19	51	27	27	22
1B246-8-4	1B248-8-4	6	1/4	-4	6.3	1/2x14	51	27	29	27
1B246-6-5	1B248-6-5	8	5/16	-5	7.9	3/8x19	52	28	28	22
1B246-6-6	1B248-6-6	10	3/8	-6	9.5	3/8x19	61	38	33	22
1B246-8-6	1B248-8-6	10	3/8	-6	9.5	1/2x14	60	38	36	27
1B246-6-8	1B248-6-8	12	1/2	-8	12.7	3/8x19	63	40	41	22
1B246-8-8	1B248-8-8	12	1/2	-8	12.7	1/2x14	63	40	41	27
1B246-10-8	1B248-10-8	12	1/2	-8	12.7	5/8x14	67	43	39	30
1B246-10-10	1B248-10-10	16	5/8	-10	15.9	5/8x14	70	45	44	30
1B246-12-10	1B248-12-10	16	5/8	-10	15.9	3/4x14	70	45	42	32
1B246-12-12	1B248-12-12	20	3/4	-12	19.1	3/4x14	80	54	53	32
1B246-16-12	1B248-16-12	20	3/4	-12	19.1	1x11	80	54	54	41
1B246-16-16	1B248-16-16	25	1	-16	25.4	1x11	104	75	69	41
1B246-20-20		32	1-1/4	-20	31.8	1-1/4x11	124	86	80	50
	1B248-20-20	32	1-1/4	-20	31.8	1-1/4x11	130	82	80	50
	1B248-24-24	40	1-1/2	-24	38.1	1-1/2x11	140	102	103	55
	1B248-32-32	50	2	-32	50.8	2x11	185	137	134	70

Approved **fitting series** for hose types:

Also available in stainless steel. Details can be found in CAT 4400.1/UK

46	or	48	441	441RH	461LT	462	462ST													
46	463	492	492ST	692	692TWIN															
48	301SN	301TC	302	304	351TC	421RH	421SN	421WC	422	426	436	451	451TC	471TC	472TC	477	477ST	493	811	881

## B4 Female BSP Parallel Pipe Swivel – 90° Elbow Block Type (60° Cone)

BS 5200-E – DKR 90°

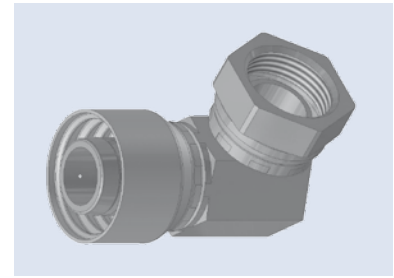
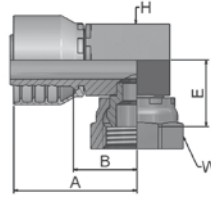

XXXXX-XX-XX Part Number		Hose I.D.				Thread BSP	A mm	B mm	E mm	H mm	W mm
46	48	DN	Inch	Size	mm						
1B446-4-4	1B448-4-4	6	1/4	-4	6.3	1/4x19	58	34	22	17	19
1B446-6-4	1B448-6-4	6	1/4	-4	6.3	3/8x19	43	20	22	17	22
1B446-6-6	1B448-6-6	10	3/8	-6	9.5	3/8x19	68	45	23	19	22
1B446-8-6	1B448-8-6	10	3/8	-6	9.5	1/2x14	67	44	27	22	27
1B446-8-8	1B448-8-8	12	1/2	-8	12.7	1/2x14	67	44	27	22	27
1B446-10-10	1B448-10-10	16	5/8	-10	15.9	5/8x14	70	45	27	27	30
1B446-12-12	1B448-12-12	20	3/4	-12	19.1	3/4x14	72	47	33	32	32
1B446-16-16	1B448-16-16	25	1	-16	25.4	1x11	82	52	34	36	41

Short version available upon request (swaging on universal crimpers only)

## EA BSP Swivel Female with O-Ring (60° Cone)

BS 5200 – ISO 12151-6 – DKOR

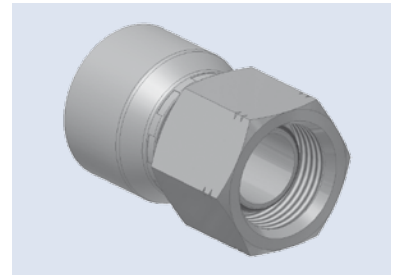
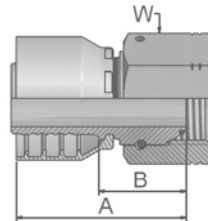

XXXXX-XX-XX Part Number		Hose I.D.				Thread BSP	A mm	B mm	W mm
46	48	DN	Inch	Size	mm				
1EA46-4-4	1EA48-4-4	6	1/4	-4	6.3	1/4x19	45	21	19
1EA46-6-4	1EA48-6-4	6	1/4	-4	6.3	3/8x19	49	26	22
1EA46-6-6	1EA48-6-6	10	3/8	-6	9.5	3/8x19	48	26	22
1EA46-8-6	1EA48-8-6	10	3/8	-6	9.5	1/2x14	51	28	27
1EA46-8-8	1EA48-8-8	12	1/2	-8	12.7	1/2x14	52	28	27
1EA46-10-10	1EA48-10-10	16	5/8	-10	15.9	5/8x14	47	21	30
1EA46-12-10	1EA48-12-10	16	5/8	-10	15.9	3/4x14	54	29	32
1EA46-12-12	1EA48-12-12	20	3/4	-12	19.1	3/4x14	50	24	32
1EA46-16-12	1EA48-16-12	20	3/4	-12	19.1	1x11	61	35	41
1EA46-16-16	1EA48-16-16	25	1	-16	25.4	1x11	62	32	41
	1EA48-20-20	32	1-1/4	-20	31.8	1-1/4x11	78	31	50

Hose fittings are delivered with ozone resistant Nitrile (NBR) O-ring as a standard version. Working temperature from -30 °C up to +105 °C. Hose fittings with special O-rings (Viton or EPDM) available on request. For O-ring dimensions and part-numbers see Section Eb.

Approved **fitting series** for hose types:

Also available in stainless steel. Details can be found in CAT 4400.1/UK

46 or 48 441 441RH 461LT 462 462ST

46 463 492 492ST 692 692TWIN

48 301SN 301TC 302 304 351TC 421RH 421SN 421WC 422 426 436 451 451TC 471TC 472TC 477 477ST 493 811 881



## EB BSP Swivel Female with O-Ring 45° Elbow (60° Cone)

BS 5200 – ISO 12151-6 – DKOR 45°

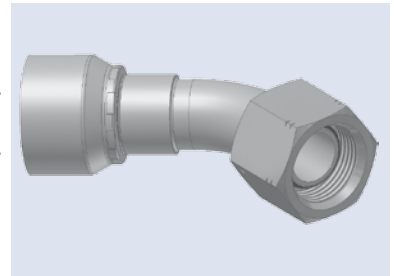
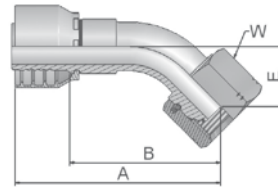

XXXXX-XX-XX Part Number		Hose I.D.				Thread BSP	A mm	B mm	E mm	W mm
46	48	DN	Inch	Size	mm					
1EB46-4-4	1EB48-4-4	6	1/4	-4	6.3	1/4x19	59	35	16	19
1EB46-6-6	1EB48-6-6	10	3/8	-6	9.5	3/8x19	69	46	17	22
1EB46-8-8	1EB48-8-8	12	1/2	-8	12.7	1/2x14	72	48	20	27
1EB46-12-10	1EB48-12-10	16	5/8	-10	15.9	3/4x14	78	52	21	32
1EB46-12-12	1EB48-12-12	20	3/4	-12	19.1	3/4x14	89	63	27	32
1EB46-16-16	1EB48-16-16	25	1	-16	25.4	1x11	113	83	33	41

Hose fittings are delivered with ozone resistant Nitrile (NBR) O-ring as a standard version. Working temperature from -30 °C up to +105 °C.  
Hose fittings with special O-rings (Viton or EPDM) available on request. For O-ring dimensions and part-numbers see Section Eb.

## EC BSP Swivel Female with O-Ring 90° Elbow (60° Cone)

BS 5200 – ISO 12151-6 – DKOR 90°

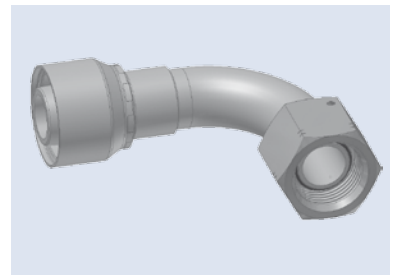
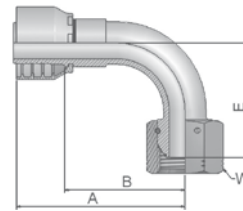

XXXXX-XX-XX Part Number		Hose I.D.				Thread BSP	A mm	B mm	E mm	W mm
46	48	DN	Inch	Size	mm					
1EC46-4-4	1EC48-4-4	6	1/4	-4	6.3	1/4x19	50	26	28	19
1EC46-6-6	1EC48-6-6	10	3/8	-6	9.5	3/8x19	61	38	33	22
1EC46-8-6	1EC48-8-6	10	3/8	-6	9.5	1/2x14	60	38	36	27
1EC46-8-8	1EC48-8-8	12	1/2	-8	12.7	1/2x14	63	40	40	27
1EC46-10-8	1EC48-10-8	12	1/2	-8	12.7	5/8x14	63	40	39	30
1EC46-10-10	1EC48-10-10	16	5/8	-10	15.9	5/8x14	70	45	44	30
1EC46-12-10	1EC48-12-10	16	5/8	-10	15.9	5/8x14	70	45	42	32
1EC46-12-12	1EC48-12-12	20	3/4	-12	19.1	3/4x14	80	54	55	32
1EC46-16-12	1EC48-16-12	20	3/4	-12	19.1	1x11	80	54	59	41
1EC46-16-16	1EC48-16-16	25	1	-16	25.4	1x11	105	75	71	41
	1EC48-20-20	32	1-1/4	-20	31.8	1-1/4x11	129	82	75	50

Hose fittings are delivered with ozone resistant Nitrile (NBR) O-ring as a standard version. Working temperature from -30 °C up to +105 °C.  
Hose fittings with special O-rings (Viton or EPDM) available on request. For O-ring dimensions and part-numbers see Section Eb.

Approved **fitting series** for hose types:

Also available in stainless steel. Details can be found in CAT 4400.1/UK

46 or 48	441 441RH 461LT 462 462ST
46	463 492 492ST 692 692TWIN
48	301SN 301TC 302 304 351TC 421RH 421SN 421WC 422 426 436 451 451TC 471TC 472TC 477 477ST 493 811 881

# D9 Male BSP Parallel Pipe Rigid – Straight (60° Cone)

BS5200 – AGR

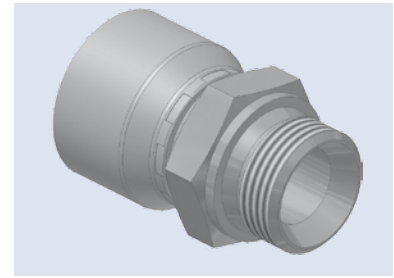
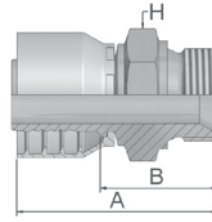

XXXXX-XX-XX Part Number		Hose I.D.				Thread BSP	A	B	H
46	48	DN	Inch	Size	mm		mm	mm	mm
1D946-2-4	1D948-2-4	6	1/4	-4	6.3	1/8x28	46	22	14
1D946-4-4	1D948-4-4	6	1/4	-4	6.3	1/4x19	51	27	19
1D946-6-4	1D948-6-4	6	1/4	-4	6.3	3/8x19	53	31	22
1D946-8-4	1D948-8-4	6	1/4	-4	6.3	1/2x14	54	52	27
1D946-4-5	1D948-4-5	8	5/16	-5	7.9	1/4x19	50	27	19
1D946-6-5	1D948-6-5	8	5/16	-5	7.9	3/8x19	55	31	22
1D946-4-6	1D948-4-6	10	3/8	-6	9.5	1/4x19	50	27	19
1D946-6-6	1D948-6-6	10	3/8	-6	9.5	3/8x19	54	31	22
1D946-8-6	1D948-8-6	10	3/8	-6	9.5	1/2x14	56	33	27
1D946-6-8	1D948-6-8	12	1/2	-8	12.7	3/8x19	54	30	22
1D946-8-8	1D948-8-8	12	1/2	-8	12.7	1/2x14	57	33	27
1D946-10-8	1D948-10-8	12	1/2	-8	12.7	5/8x14	59	35	30
1D946-12-8	1D948-12-8	12	1/2	-8	12.7	3/4x14	60	36	32
1D946-8-10	1D948-8-10	16	5/8	-10	15.9	1/2x14	59	33	27
1D946-10-10	1D948-10-10	16	5/8	-10	15.9	5/8x14	61	36	30
1D946-12-10	1D948-12-10	16	5/8	-10	15.9	3/4x14	62	37	32
1D946-12-12	1D948-12-12	20	3/4	-12	19.1	3/4x14	62	36	32
1D946-16-12	1D948-16-12	20	3/4	-12	19.1	1x11	68	42	41
1D946-16-16	1D948-16-16	25	1	-16	25.4	1x11	72	42	41
1D946-20-16	1D948-20-16	25	1	-16	25.4	1-1/4x11	75	46	50
1D946-20-20		32	1-1/4	-20	31.8	1-1/4x11	85	47	50
	1D948-20-20	32	1-1/4	-20	31.8	1-1/4x11	92	45	50
	1D948-24-24	40	1-1/2	-24	38.1	1-1/2x11	87	49	60
	1D948-32-32	50	2	-32	50.8	2	102	54	70

Approved **fitting series** for hose types:

Also available in stainless steel. Details can be found in CAT 4400.1/UK

46	or	48	441	441RH	461LT	462	462ST													
46	463	492	492ST	692	692TWIN															
48	301SN	301TC	302	304	351TC	421RH	421SN	421WC	422	426	436	451	451TC	471TC	472TC	477	477ST	493	811	881

# 91 Male BSP Taper Pipe – Rigid Straight

BS5200 – AGR-K

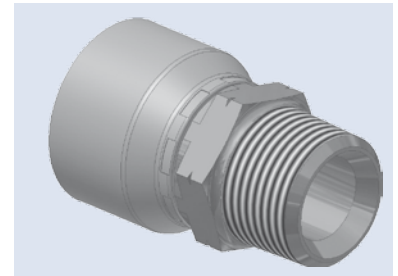
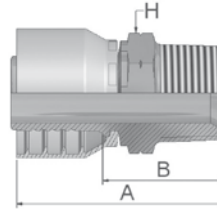

XXXXX-XX-XX Part Number		Hose I.D.				Thread BSP	A mm	B mm	H mm
46	48	DN	Inch	Size	mm				
19146-4-4	19148-4-4	6	1/4	-4	6.3	1/4x19	49	26	14
19146-6-4	19148-6-4	6	1/4	-4	6.3	3/8x19	51	28	17
19146-4-5	19148-4-5	8	5/16	-5	7.9	1/4x19	49	25	14
19146-6-5	19148-6-5	8	5/16	-5	7.9	3/8x19	48	24	19
19146-4-6	19148-4-6	10	3/8	-6	9.5	1/4x19	47	24	14
19146-6-6	19148-6-6	10	3/8	-6	9.5	3/8x19	52	27	19
19146-8-6	19148-8-6	10	3/8	-6	9.5	1/2x14	57	34	22
19146-6-8	19148-6-8	12	1/2	-8	12.7	3/8x19	48	25	17
19146-8-8	19148-8-8	12	1/2	-8	12.7	1/2x14	57	33	22
19146-12-10	19148-12-10	16	5/8	-10	15.9	3/4x14	63	38	27
19146-12-12	19148-12-12	20	3/4	-12	19.1	3/4x14	63	37	30
19146-16-16	19148-16-16	25	1	-16	25.4	1x11	72	42	36

# B5 Female BSP Parallel Pipe Swivel Straight (Flat Seat)

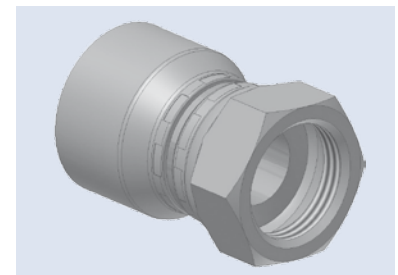
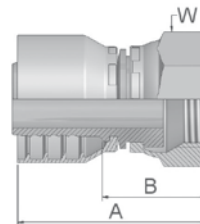

XXXXX-XX-XX Part Number		Hose I.D.				Thread BSP	A mm	B mm	W mm
46	48	DN	Inch	Size	mm				
1B546-4-4	1B548-4-4	6	1/4	-4	6.3	1/4x19	41	17	19
1B546-4-5	1B548-4-5	8	5/16	-5	7.9	1/4x19	41	17	19
1B546-6-5	1B548-6-5	8	5/16	-5	7.9	3/8x19	38	14	22
1B546-8-5	1B548-8-5	8	5/16	-5	7.9	1/2x14	44	21	27
1B546-6-6	1B548-6-6	10	3/8	-6	9.5	3/8x19	37	14	22
1B546-8-6	1B548-8-6	10	3/8	-6	9.5	1/2x14	43	20	27
1B546-8-8	1B548-8-8	12	1/2	-8	12.7	1/2x14	43	19	27
1B546-12-8	1B548-12-8	12	1/2	-8	12.7	3/4x14	43	19	32
1B546-12-10	1B548-12-10	16	5/8	-10	15.9	3/4x14	43	18	32
1B546-12-12	1B548-12-12	20	3/4	-12	19.1	3/4x14	44	18	32
1B546-16-16	1B548-16-16	25	1	-16	25.4	1x11	51	22	41

Approved fitting series for hose types:

Also available in stainless steel. Details can be found in CAT 4400.1/UK

- 46 or 48 441 441RH 461LT 462 462ST
- 46 463 492 492ST 692 692TWIN
- 48 301SN 301TC 302 304 351TC 421RH 421SN 421WC 422 426 436 451 451TC 471TC 472TC 477 477ST 493 811 881

# 01 Male NPTF Pipe Rigid – Straight

SAE J476A / J516 – AGN

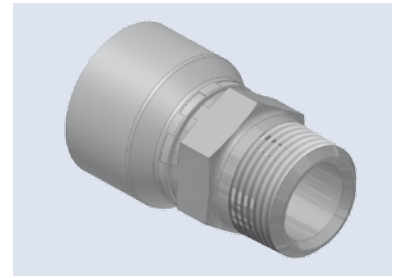
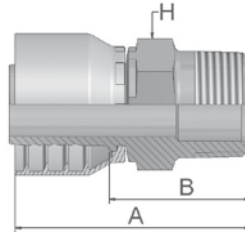

XXXXX-XX-XX Part Number		Hose I.D.				Thread NPTF	A	B	H
46	48	DN	Inch	Size	mm		mm	mm	mm
10146-2-4	10148-2-4	6	1/4	-4	6.3	1/8x27	48	24	12
10146-4-4	10148-4-4	6	1/4	-4	6.3	1/4x18	53	29	14
10146-6-4	10148-6-4	6	1/4	-4	6.3	3/8x18	55	31	19
10146-4-5	10148-4-5	8	5/16	-5	7.9	1/4x18	53	29	14
10146-6-5	10148-6-5	8	5/16	-5	7.9	3/8x18	55	31	19
10146-4-6	10148-4-6	10	3/8	-6	9.5	1/4x18	52	29	14
10146-6-6	10148-6-6	10	3/8	-6	9.5	3/8x18	54	31	19
10146-8-6	10148-8-6	10	3/8	-6	9.5	1/2x14	55	32	22
10146-6-8	10148-6-8	12	1/2	-8	12.7	3/8x18	55	32	19
10146-8-8	10148-8-8	12	1/2	-8	12.7	1/2x14	61	38	22
10146-8-10	10148-8-10	16	5/8	-10	15.9	1/2x14	63	38	22
10146-12-10	10148-12-10	16	5/8	-10	15.9	3/4x14	59	34	27
10146-12-12	10148-12-12	20	3/4	-12	19.1	3/4x14	60	34	27
10146-16-16	10148-16-16	25	1	-16	25.4	1x11-1/2	75	45	36
10146-20-20		32	1-1/4	-20	31.8	1-1/4x11-1/2	86	48	46
	10148-20-20	32	1-1/4	-20	31.8	1-1/4x11-1/2	104	57	46
	10148-24-24	40	1-1/2	-24	38.1	1-1/2x11-1/2	89	51	50
	10148-32-32	50	2	-32	50.8	2x11-1/2	104	55	65

Approved **fitting series** for hose types:

Also available in stainless steel. Details can be found in CAT 4400.1/UK

46 or 48 441 441RH 461LT 462 462ST

46 463 492 492ST 692 692TWIN

48 301SN 301TC 302 304 351TC 421RH 421SN 421WC 422 426 436 451 451TC 471TC 472TC 477 477ST 493 811 881

# 03

## Male JIC 37° – Rigid Straight

ISO12151-5-S – AGJ

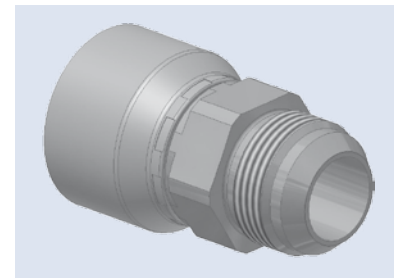
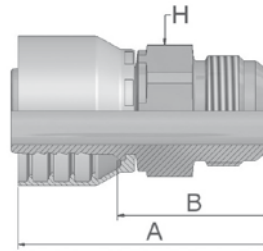

XXXXX-XX-XX Part Number		Hose I.D.				Thread UNF	A	B	H
46	48	DN	Inch	Size	mm		mm	mm	mm
10346-4-4	10348-4-4	6	1/4	-4	6.3	7/16x20	52	29	14
10346-5-4	10348-5-4	6	1/4	-4	6.3	1/2x20	52	29	14
10346-6-4	10348-6-4	6	1/4	-4	6.3	9/16x18	55	31	19
10346-5-5	10348-5-5	8	5/16	-5	7.9	1/2x20	50	26	14
10346-6-5	10348-6-5	8	5/16	-5	7.9	9/16x18	55	31	19
10346-8-5	10348-8-5	8	5/16	-5	7.9	3/4x16	57	33	19
10346-4-6	10348-4-6	10	3/8	-6	9.5	7/16x20	54	31	19
10346-5-6	10348-5-6	10	3/8	-6	9.5	1/2x20	53	30	19
10346-6-6	10348-6-6	10	3/8	-6	9.5	9/16x18	56	31	19
10346-8-6	10348-8-6	10	3/8	-6	9.5	3/4x16	53	30	22
10346-10-6	10348-10-6	10	3/8	-6	9.5	7/8x14	56	33	24
10346-8-8	10348-8-8	12	1/2	-8	12.7	3/4x16	57	34	22
10346-10-8	10348-10-8	12	1/2	-8	12.7	7/8x14	56	32	24
10346-12-8	10348-12-8	12	1/2	-8	12.7	1-1/16x12	62	38	27
10346-10-10	10348-10-10	16	5/8	-10	15.9	7/8x14	63	38	24
10346-12-10	10348-12-10	16	5/8	-10	15.9	1-1/16x12	64	39	27
10346-12-12	10348-12-12	20	3/4	-12	19.1	1-1/16x12	68	42	27
10346-14-12	10348-14-12	20	3/4	-12	19.1	1-3/16x12	68	42	30
10346-16-12	10348-16-12	20	3/4	-12	19.1	1-5/16x12	64	38	36
10346-16-16	10348-16-16	25	1	-16	25.4	1-5/16x12	76	46	36
10346-20-16	10348-20-16	25	1	-16	25.4	1-5/8x12	73	43	46
10346-20-20		32	1-1/4	-20	31.8	1-5/8x12	86	48	46
	10348-20-20	32	1-1/4	-20	31.8	1-5/8x12	101	53	46
	10348-24-24	40	1-1/2	-24	38.1	1-7/8x12	85	47	50
	10348-32-32	50	2	-32	50.8	2-1/2x12	109	61	65

Approved fitting series for hose types:

Also available in stainless steel. Details can be found in CAT 4400.1/UK

46	or	48	441	441RH	461LT	462	462ST													
46	463	492	492ST	692	692TWIN															
48	301SN	301TC	302	304	351TC	421RH	421SN	421WC	422	426	436	451	451TC	471TC	472TC	477	477ST	493	811	881

## 04 Male SAE 45° – Rigid Straight

SAE J516

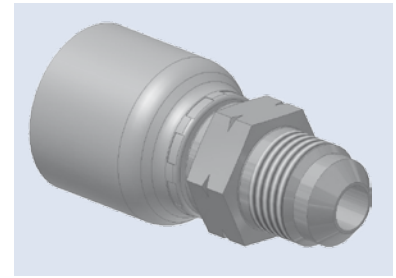
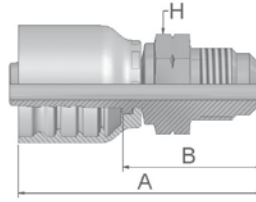

XXXXX-XX-XX Part Number		Hose I.D.				Thread UNF	A	B	H
46	48	DN	Inch	Size	mm		mm	mm	mm
10446-6-6	10448-6-6	10	3/8	-6	9.5	5/8x18	54	31	19

## 05 Male SAE Straight Thread with O-Ring – Rigid Straight

ISO 11926 – SAE J516

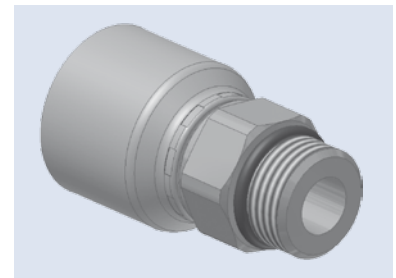
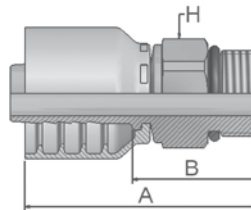

XXXXX-XX-XX Part Number		Hose I.D.				Thread UNF	A	B	H
46	48	DN	Inch	Size	mm		mm	mm	mm
10546-8-6	10548-8-6	10	3/8	-6	9.5	3/4x16	48	25	22
10546-8-8	10548-8-8	12	1/2	-8	12.7	3/4x16	52	28	22
10546-10-8	10548-10-8	12	1/2	-8	12.7	7/8x14	49	26	27

To select corresponding O-ring see Section Eb.

Approved **fitting series** for hose types:

Also available in stainless steel. Details can be found in CAT 4400.1/UK

46	or	48	441	441RH	461LT	462	462ST													
46	463	492	492ST	692	692TWIN															
48	301SN	301TC	302	304	351TC	421RH	421SN	421WC	422	426	436	451	451TC	471TC	472TC	477	477ST	493	811	881

**06/68 Female – JIC 37°  
SAE 45° Dual Flare  
Swivel – Straight**

ISO12151-5-SWS – DKJ

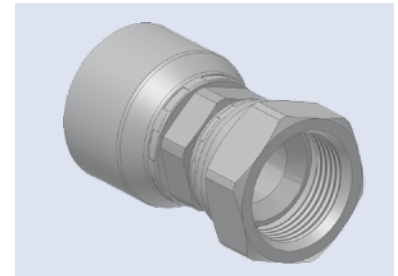
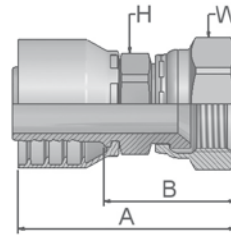

XXXXX-XX-XX Part Number		Hose I.D.				Thread UNF	A	B	H	W
46	48	DN	Inch	Size	mm		mm	mm	mm	mm
10646-6-4	10648-6-4	6	1/4	-4	6.3	9/16x18	55	31	14	19
16846-4-4	16848-4-4	6	1/4	-4	6.3	7/16x20	52	29	14	17
16846-5-4	16848-5-4	6	1/4	-4	6.3	1/2x20	54	30	14	17
10646-6-5	10648-6-5	8	5/16	-5	7.9	9/16x18	56	29	14	19
16846-5-5	16848-5-5	8	5/16	-5	7.9	1/2x20	54	30	14	17
16846-8-5	16848-8-5	8	5/16	-5	7.9	3/4x16	57	34	17	22
10646-6-6	10648-6-6	10	3/8	-6	9.5	9/16x18	52	30	14	19
16846-4-6	16848-4-6	10	3/8	-6	9.5	7/16x20	50	27	14	17
16846-5-6	16848-5-6	10	3/8	-6	9.5	1/2x20	52	29	14	17
16846-8-6	16848-8-6	10	3/8	-6	9.5	3/4x16	56	34	17	22
16846-10-6	16848-10-6	10	3/8	-6	9.5	7/8x14	59	36	22	27
10646-6-8	10648-6-8	12	1/2	-8	12.7	9/16x18	55	32	22	19
10646-12-8	10648-12-8	12	1/2	-8	12.7	1-1/16x12	62	38	22	32
16846-8-8	16848-8-8	12	1/2	-8	12.7	3/4x16	56	32	22	22
16846-10-8	16848-10-8	12	1/2	-8	12.7	7/8x14	62	38	27	27
10646-12-10	10648-12-10	16	5/8	-10	15.9	1-1/16x12	64	39	22	32
16846-8-10	16848-8-10	16	5/8	-10	15.9	3/4x16	57	32	22	22
16846-10-10	16848-10-10	16	5/8	-10	15.9	7/8x14	60	35	27	27
10646-12-12	10648-12-12	20	3/4	-12	19.1	1-1/16x12	67	41	24	32
10646-14-12	10648-14-12	20	3/4	-12	19.1	1-3/16x12	68	42	24	36
10646-16-12	10648-16-12	20	3/4	-12	19.1	1-5/16x12	71	45	27	41
16846-8-12	16848-8-12	20	3/4	-12	19.1	3/4x16	58	32	30	22
16846-10-12	16848-10-12	20	3/4	-12	19.1	7/8x14	61	35	32	27
10646-12-16	10648-12-16	25	1	-16	25.4	1-1/16x12	73	44	32	32
10646-16-16	10648-16-16	25	1	-16	25.4	1-5/16x12	76	46	32	41
10646-20-16	10648-20-16	25	1	-16	25.4	1-5/8x12	80	50	41	50
10646-16-20		32	1-1/4	-20	31.8	1-5/16x12	87	49	41	41
	10648-16-20	32	1-1/4	-20	31.8	1-5/16x12	97	50	46	41
10646-20-20		32	1-1/4	-20	31.8	1-5/8x12	89	51	46	50
	10648-20-20	32	1-1/4	-20	31.8	1-5/8x12	100	53	46	50
	10648-24-24	40	1-1/2	-24	38.1	1-7/8x12	98	60	55	60

Approved fitting series for hose types:

Also available in stainless steel. Details can be found in CAT 4400.1/UK

46	or	48	441	441RH	461LT	462	462ST													
46	463	492	492ST	692	692TWIN															
48	301SN	301TC	302	304	351TC	421RH	421SN	421WC	422	426	436	451	451TC	471TC	472TC	477	477ST	493	811	881

## 08 Female SAE 45° – Swivel Straight

SAE J516

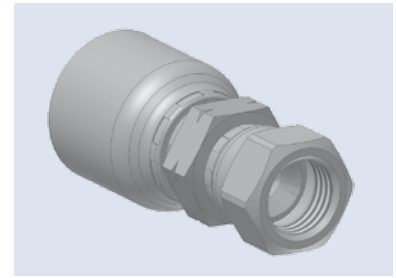
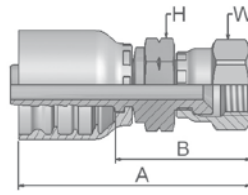

XXXXX-XX-XX Part Number		Hose I.D.				Thread	A	B	H	W
46	48	DN	Inch	Size	mm	UNF	mm	mm	mm	mm
10846-6-6	10848-6-6	10	3/8	-6	9.5	5/8x18	57	34	19	19

## 33 Male JIC 37° – Rigid 45° Elbow

ISO 12151-5 – AGJ 45°

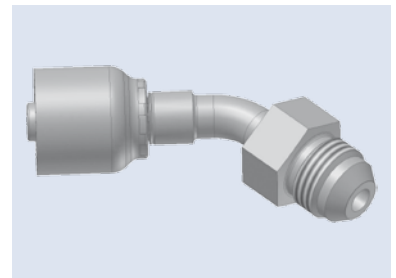
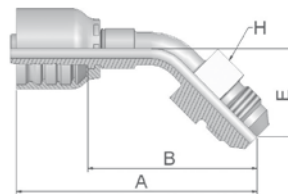

XXXXX-XX-XX Part Number		Hose I.D.				Thread	A	B	E	H
46	48	DN	Inch	Size	mm	NPTF	mm	mm	mm	mm
13346-8-6	13348-8-6	10	3/8	-6	9.5	3/4x16	77	54	28	22

Approved **fitting series** for hose types:

Also available in stainless steel. Details can be found in CAT 4400.1/UK

46 or 48	441 441RH 461LT 462 462ST
46	463 492 492ST 692 692TWIN
48	301SN 301TC 302 304 351TC 421RH 421SN 421WC 422 426 436 451 451TC 471TC 472TC 477 477ST 493 811 881



# 37/3V Female JIC 37° SAE 45° – Dual Flare Swivel Female 45° Elbow

ISO 12151-5-SWE 45° – DKJ 45°

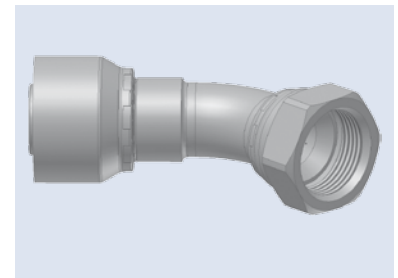
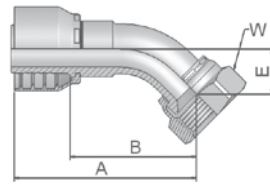

XXXXX-XX-XX Part Number		Hose I.D.				Thread UNF	A	B	E	W
46	48	DN	Inch	Size	mm		mm	mm	mm	mm
13746-6-4	13748-6-4	6	1/4	-4	6.3	9/16x18	55	31	11	19
13V46-4-4	13V48-4-4	6	1/4	-4	6.3	7/16x20	53	29	10	17
13V46-5-4	13V48-5-4	6	1/4	-4	6.3	1/2x20	57	33	9	17
13746-6-5	13748-6-5	8	5/16	-5	7.9	9/16x18	58	35	10	19
13V46-5-5	13V48-5-5	8	5/16	-5	7.9	1/2x20	53	29	10	17
13746-6-6	13748-6-6	10	3/8	-6	9.5	9/16x18	60	37	11	19
13V46-8-6	13V48-8-6	10	3/8	-6	9.5	3/4x16	67	44	15	22
13V46-10-6	13V48-10-6	10	3/8	-6	9.5	7/8-14	69	46	17	27
13V46-8-8	13V48-8-8	12	1/2	-8	12.7	3/4x16	61	37	15	22
13V46-10-8	13V48-10-8	12	1/2	-8	12.7	7/8x14	70	46	16	27
13746-12-10	13748-12-10	16	5/8	-10	15.9	1-1/16x12	74	49	21	32
13V46-10-10	13V48-10-10	16	5/8	-10	15.9	7/8x14	69	44	16	27
13746-12-12	13748-12-12	20	3/4	-12	19.1	1-1/16x12	83	58	22	32
13746-14-12	13748-14-12	20	3/4	-12	19.1	1-3/16x12	84	58	22	36
13746-16-12	13748-16-12	20	3/4	-12	19.1	1-5/16x12	84	58	24	41
13746-12-16	13748-12-16	25	1	-16	25.4	1-1/16x12	91	61	21	32
13746-16-16	13748-16-16	25	1	-16	25.4	1-5/16x12	99	70	24	41
13746-20-16	13748-20-16	25	1	-16	25.4	1-5/8x12	101	71	26	50
13746-20-20		32	1-1/4	-20	31.8	1-5/8x12	129	91	31	50
	13748-20-20	32	1-1/4	-20	31.8	1-5/8x12	134	87	30	50
	13748-24-24	40	1-1/2	-24	38.1	1-7/8x12	165	127	58	60

Approved fitting series for hose types:



Also available in stainless steel. Details can be found in CAT 4400.1/UK

46	or	48	441	441RH	461LT	462	462ST													
46	463	492	492ST	692	692TWIN															
48	301SN	301TC	302	304	351TC	421RH	421SN	421WC	422	426	436	451	451TC	471TC	472TC	477	477ST	493	811	881

# 39/3W Female JIC 37° SAE 45° – Dual Flare Swivel Female 90° Elbow

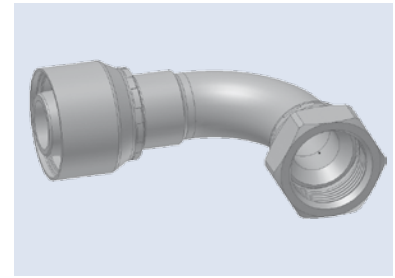
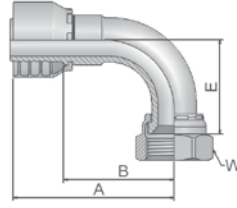
ISO 12151-5-SWES – DKJ 90°

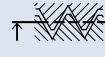

XXXXX-XX-XX		 Hose I.D.				 Thread UNF	A	B	E	 W
Part Number		DN	Inch	Size	mm		mm	mm	mm	mm
46	48									
13946-6-4	13948-6-4	6	1/4	-4	6.3	9/16x18	49	25	23	19
13W46-4-4	13W48-4-4	6	1/4	-4	6.3	7/16x20	48	24	21	17
13W46-5-4	13W48-5-4	6	1/4	-4	6.3	1/2x20	58	34	21	17
13946-6-5	13948-6-5	8	5/16	-5	7.9	9/16x18	51	28	23	19
13W46-5-5	13W48-5-5	8	5/16	-5	7.9	1/2x20	49	25	21	17
13946-6-6	13948-6-6	10	3/8	-6	9.5	9/16x18	51	28	23	19
13W46-4-6	13W48-4-6	10	3/8	-6	9.5	7/16x20	46	23	21	17
13W46-8-6	13W48-8-6	10	3/8	-6	9.5	3/4x16	59	36	29	22
13W46-10-6	13W48-10-6	10	3/8	-6	9.5	7/8x14	61	38	32	27
13946-6-8	13948-6-8	12	1/2	-8	12.7	9/16x18	54	30	23	19
13W46-8-8	13W48-8-8	12	1/2	-8	12.7	3/4x16	55	31	29	22
13W46-10-8	13W48-10-8	12	1/2	-8	12.7	7/8x14	63	39	32	27
13946-12-10	13948-12-10	16	5/8	-10	15.9	1-1/16x12	75	49	48	32
13W46-10-10	13W48-10-10	16	5/8	-10	15.9	7/8x14	64	39	33	27
13946-12-12	13948-12-12	20	3/4	-12	19.1	1-1/16x12	80	54	48	32
13946-14-12	13948-14-12	20	3/4	-12	19.1	1-3/16x12	80	54	51	36
13946-16-12	13948-16-12	20	3/4	-12	19.1	1-5/16x12	80	54	56	41
13946-12-16	13948-12-16	25	1	-16	25.4	1-1/16x12	88	58	48	32
13946-16-16	13948-16-16	25	1	-16	25.4	1-5/16x12	98	68	56	41
13946-20-16	13948-20-16	25	1	-16	25.4	1-5/8x12	98	68	62	50
13946-20-20		32	1-1/4	-20	31.8	1-5/8x12	124	86	70	50
	13948-20-20	32	1-1/4	-20	31.8	1-5/8x12	129	82	70	50
	13948-24-20°	32	1-1/4	-20	31.8	1-7/8x12	130	82	80	60
	13948-24-24	40	1-1/2	-24	38.1	1-7/8x12	140	102	84	60
	13948-32-32	50	2	-32	50.8	2-1/2x12	185	137	145	75

\*Assembly only with Parkrimp 2 machine

Approved **fitting series** for hose types:

Also available in stainless steel. Details can be found in CAT 4400.1/UK

**46** or **48** 441 441RH 461LT 462 462ST

**46** 463 492 492ST 692 692TWIN

**48** 301SN 301TC 302 304 351TC 421RH 421SN 421WC 422 426 436 451 451TC 471TC 472TC 477 477ST 493 811 881

# 41/3Y Female JIC 37° / 45° Swivel Female 90° Elbow (Long)

ISO 12151-5-SWEL – DKJ 90°L

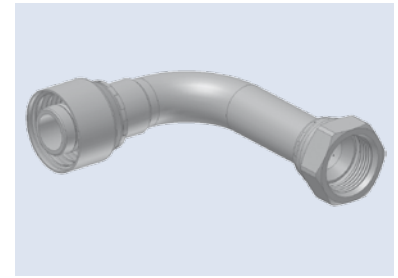
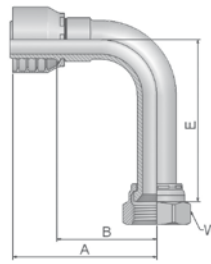

XXXXX-XX-XX Part Number		Hose I.D.				Thread UNF	A	B	E	W
46	48	DN	Inch	Size	mm		mm	mm	mm	mm
13Y46-4-4	13Y48-4-4	6	1/4	-4	6.3	7/16x20	61	37	46	17
14146-6-4	14148-6-4	6	1/4	-4	6.3	9/16x18	57	34	55	19
14146-6-6	14148-6-6	10	3/8	-6	9.5	9/16x18	57	34	54	19
13Y46-8-6	13Y48-8-6	10	3/8	-6	9.5	3/4x16	55	32	62	22
13Y46-8-8	13Y48-8-8	12	1/2	-8	12.7	3/4x16	59	36	64	22
14146-10-8	14148-10-8	12	1/2	-8	12.7	7/8x14	62	39	70	27
	14148-10-10	16	5/8	-10	15.9	7/8x14	64	39	66	27
13Y46-10-10	13Y48-10-10	16	5/8	-10	15.9	7/8x14	61	36	70	27
14146-12-12	14148-12-12	20	3/4	-12	19.1	1-1/16x12	80	54	96	32
	13Y48-12-12	20	3/4	-12	19.1	1-1/16x12	71	45	95	32
14146-16-16	14148-16-16	25	1	-16	25.4	1-5/16x12	98	68	110	41

# L9 Female JIC 37° – Swivel 90° Elbow – Medium Drop

ISO 12151-5-SWEM – DKJ 90° M

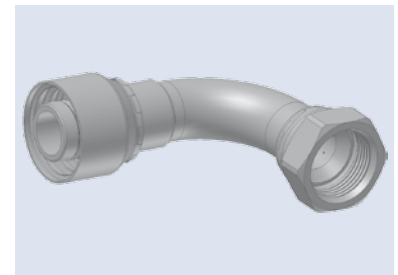
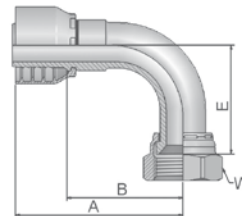

XXXXX-XX-XX Part Number		Hose I.D.				Thread UNF	A	B	E	W
46	48	DN	Inch	Size	mm		mm	mm	mm	mm
1L946-8-6	1L948-8-6	10	3/8	-6	9.5	3/4x16	63	40	35	22
1L946-12-12	1L948-12-12	20	3/4	-12	19.1	1-1/16x12	80	54	53	32
1L946-16-16	1L948-16-16	25	1	-16	25.4	1-5/16x12	97	68	64	41

Approved fitting series for hose types:



Also available in stainless steel. Details can be found in CAT 4400.1/UK

46 or 48	441 441RH 461LT 462 462ST
46	463 492 492ST 692 692TWIN
48	301SN 301TC 302 304 351TC 421RH 421SN 421WC 422 426 436 451 451TC 471TC 472TC 477 477ST 493 811 881

# 15 SAE Code 61 – Flange Head Straight

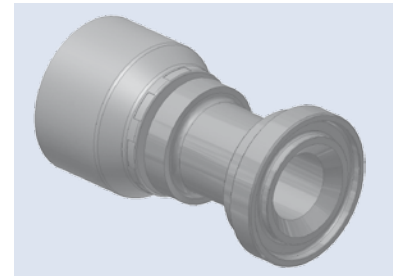
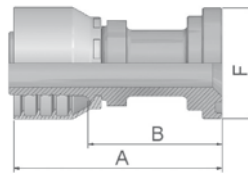
ISO 12151-3-S-L – SFL  
3000 psi



XXXXX-XX-XX Part Number		 Hose I.D.				 Flange	A	B	F
46	48	DN	Inch	Size	mm		mm	mm	mm
11546-8-8	11548-8-8	12	1/2	-8	12.7	1/2	74	51	30
11546-12-8	11548-12-8	12	1/2	-8	12.7	3/4	51	27	38
11546-12-10	11548-12-10	16	5/8	-10	15.9	3/4	56	31	38
11546-12-12	11548-12-12	20	3/4	-12	19.1	3/4	82	56	38
11546-16-12	11548-16-12	20	3/4	-12	19.1	1	56	30	45
11546-20-12	11548-20-12	20	3/4	-12	19.1	1-1/4	77	51	51
11546-16-16	11548-16-16	25	1	-16	25.4	1	84	54	45
11546-20-16	11548-20-16	25	1	-16	25.4	1-1/4	65	35	51
11546-24-16	11548-24-16	25	1	-16	25.4	1-1/2	97	67	60
	11548-16-20	32	1-1/4	-20	31.8	1	111	64	45
11546-20-20		32	1-1/4	-20	31.8	1-1/4	114	76	51
	11548-20-20	32	1-1/4	-20	31.8	1-1/4	120	72	51
11546-24-20		32	1-1/4	-20	31.8	1-1/2	72	35	60
	11548-24-24	40	1-1/2	-24	38.1	1-1/2	117	79	60
	11548-32-24	40	1-1/2	-24	38.1	2	80	42	71
	11548-24-32	50	2	-32	50.8	1-1/2	129	81	60
	11548-32-32	50	2	-32	50.8	2	127	79	71

To select corresponding half-flange and O-ring see Section Eb.

Approved **fitting series** for hose types:

Also available in stainless steel. Details can be found in CAT 4400.1/UK

46	or	48	441	441RH	461LT	462	462ST													
46	463	492	492ST	692	692TWIN															
48	301SN	301TC	302	304	351TC	421RH	421SN	421WC	422	426	436	451	451TC	471TC	472TC	477	477ST	493	811	881

# 17 SAE Code 61 – Flange Head 45° Elbow

ISO 12151-3 – E45 – L – SFL 45°  
3000 psi

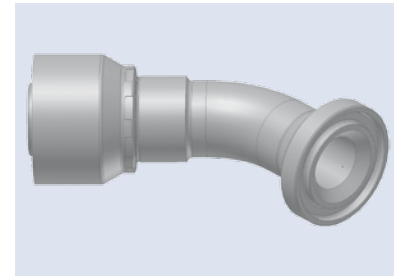
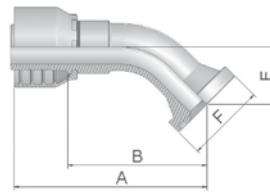

XXXXX-XX-XX Part Number		Hose I.D.				Flange	A	B	E	F
46	48	DN	Inch	Size	mm		mm	mm	mm	mm
11746-8-8	11748-8-8	12	1/2	-8	12.7	1/2	72	48	20	30
11746-12-8	11748-12-8	12	1/2	-8	12.7	3/4	71	47	21	38
11746-12-10	11748-12-10	16	5/8	-10	15.9	3/4	75	50	24	38
11746-12-12	11748-12-12	20	3/4	-12	19.1	3/4	88	62	26	38
11746-16-12	11748-16-12	20	3/4	-12	19.1	1	88	62	26	45
11746-20-12	11748-20-12	20	3/4	-12	19.1	1-1/4	87	61	25	51
11746-16-16	11748-16-16	25	1	-16	25.4	1	109	78	32	45
11746-20-16	11748-20-16	25	1	-16	25.4	1-1/4	109	79	32	51
	11748-16-20	32	1-1/4	-20	31.8	1	141	94	38	45
11746-20-20		32	1-1/4	-20	31.8	1-1/4	136	98	38	51
	11748-20-20	32	1-1/4	-20	31.8	1-1/4	141	94	38	51
11746-24-20		32	1-1/4	-20	31.8	1-1/2	136	98	38	60
	11748-24-24	40	1-1/2	-24	38.1	1-1/2	151	113	44	60
	11748-32-24	40	1-1/2	-24	38.1	2	150	112	44	71
	11748-24-32	50	2	-32	50.8	1-1/2	153	105	36	60
	11748-32-32	50	2	-32	50.8	2	202	153	56	71

To select corresponding half-flange and O-ring see Section Eb.

Approved fitting series for hose types:





Also available in stainless steel. Details can be found in CAT 4400.1/UK

46 or 48	441 441RH 461LT 462 462ST
46	463 492 492ST 692 692TWIN
48	301SN 301TC 302 304 351TC 421RH 421SN 421WC 422 426 436 451 451TC 471TC 472TC 477 477ST 493 811 881

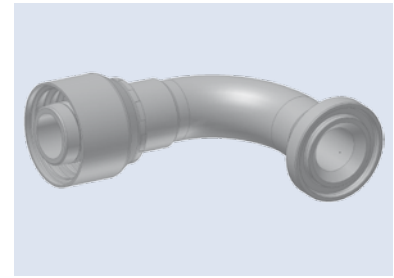
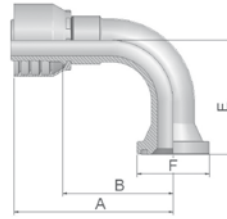
# 19 SAE Code 61 – Flange Head 90° Elbow

ISO 12151-3 – E– L – SFL 90°  
3000 psi







XXXXX-XX-XX		 Hose I.D.				 Flange	A	B	E	F
Part Number		DN	Inch	Size	mm		mm	mm	mm	mm
 46	 48									
11946-8-8	11948-8-8	12	1/2	-8	12.7	1/2	64	40	41	30
11946-12-8	11948-12-8	12	1/2	-8	12.7	3/4	71	47	43	38
11946-12-10	11948-12-10	16	5/8	-10	15.9	3/4	78	53	52	38
11946-16-10	11948-16-10	16	5/8	-10	15.9	1	78	53	52	45
11946-12-12	11948-12-12	20	3/4	-12	19.1	3/4	80	54	58	38
11946-16-12	11948-16-12	20	3/4	-12	19.1	1	80	54	58	45
11946-20-12	11948-20-12	20	3/4	-12	19.1	1-1/4	81	55	54	51
11946-12-16	11948-12-16	25	1	-16	25.4	3/4	98	68	70	38
11946-16-16	11948-16-16	25	1	-16	25.4	1	98	68	70	45
11946-20-16	11948-20-16	25	1	-16	25.4	1-1/4	102	72	70	51
11946-24-16°	11948-24-16	25	1	-16	25.4	1-1/2	100	70	62	60
11946-20-20		32	1-1/4	-20	31.8	1-1/4	124	86	90	51
	11948-20-20	32	1-1/4	-20	31.8	1-1/4	130	82	90	51
11946-24-20		32	1-1/4	-20	31.8	1-1/2	124	86	90	60
	11948-24-20	32	1-1/4	-20	31.8	1-1/2	129	82	90	60
	11948-24-24	40	1-1/2	-24	38.1	1-1/2	140	102	79	60
	11948-32-24	40	1-1/2	-24	38.1	2	139	101	104	71
	11948-24-32	50	2	-32	50.8	1-1/2	154	106	104	60
	11948-32-32	50	2	-32	50.8	2	186	138	114	71

°Assembly only with Parkrimp 2 machine  
To select corresponding half-flange and O-ring see Section Eb.

Approved **fitting series** for hose types:

Also available in stainless steel. Details can be found in CAT 4400.1/UK

 46	or	 48	441 441RH 461LT 462 462ST
 46	463 492 492ST 692 692TWIN		
 48	301SN 301TC 302 304 351TC 421RH 421SN 421WC 422 426 436 451 451TC 471TC 472TC 477 477ST 493 811 881		

## 6A SAE Code 62 Flange Straight

ISO 12151-3-S-S – SFS  
6000 psi

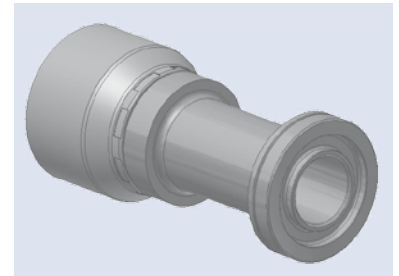
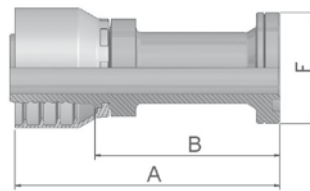

XXXXX-XX-XX Part Number		Hose I.D.				Flange	A	B	F
46	48	DN	Inch	Size	mm		mm	mm	mm
16A46-8-8	16A48-8-8	12	1/2	-8	12.7	1/2	75	51	32
16A46-12-12	16A48-12-10	20	3/4	-12	19.1	3/4	60	35	41
	16A48-12-12	25	1	-16	25.4	3/4	96	70	41
16A46-12-16	16A48-12-16	25	1	-16	25.4	3/4	99	69	41
16A46-16-16	16A48-16-16	25	1	-16	25.4	1	111	82	48
16A46-20-20		32	1-1/4	-20	31.8	1-1/4	122	84	54
	16A48-20-20	32	1-1/4	-20	31.8	1-1/4	130	83	54
	16A48-24-24	40	1-1/2	-24	38.1	1-1/2	141	103	64
	16A48-32-32	50	2	-32	50.8	2	173	124	79

To select corresponding half-flange and O-ring see Section Eb.

## 6F SAE Code 62 Flange 45° Elbow – Heavy Series

ISO 12151-3 – E45-S – SFS 45°  
6000 psi

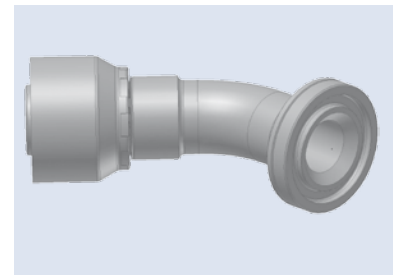
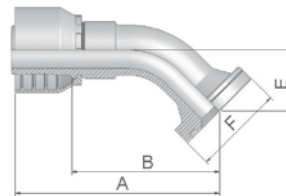

XXXXX-XX-XX Part Number		Hose I.D.				Flange	A	B	E	F
46	48	DN	Inch	Size	mm		mm	mm	mm	mm
16F46-12-12	16F48-12-12	20	3/4	-12	19.1	3/4	88	62	26	41
16F46-16-16	16F48-16-16	25	1	-16	25.4	1	107	78	32	48
	16F48-20-20	32	1-1/4	-20	31.8	1-1/4	141	94	38	54
	16F48-24-24	40	1-1/2	-24	38.1	1-1/2	150	112	44	64

To select corresponding half-flange and O-ring see Section Eb.

Approved **fitting series** for hose types:

Also available in stainless steel. Details can be found in CAT 4400.1/UK

46	or	48	441	441RH	461LT	462	462ST													
46	463	492	492ST	692	692TWIN															
48	301SN	301TC	302	304	351TC	421RH	421SN	421WC	422	426	436	451	451TC	471TC	472TC	477	477ST	493	811	881

# 6N SAE Code 62 Flange 90° Elbow

ISO 12151-3 – E-S – SFS 90°  
6000 psi

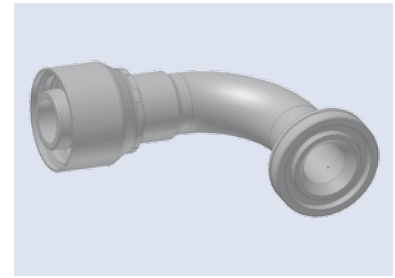
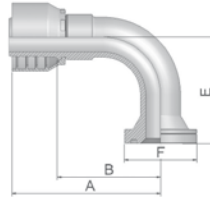

XXXXX-XX-XX		Hose I.D.				Flange	A	B	E	F
Part Number		DN	Inch	Size	mm		mm	mm	mm	mm
46	48									
16N46-8-12	16N48-8-12	20	3/4	-12	19.1	1/2	70	44	40	32
16N46-12-12	16N48-12-12	20	3/4	-12	19.1	3/4	80	54	54	41
16N46-16-12	16N48-16-12	20	3/4	-12	19.1	1	80	54	53	48
16N46-12-16	16N48-12-16	25	1	-16	25.4	3/4	88	58	58	41
16N46-16-16	16N48-16-16	25	1	-16	25.4	1	98	68	70	48
16N46-20-20		32	1-1/4	-20	31.8	1-1/4	124	86	90	54
	16N48-20-20	32	1-1/4	-20	31.8	1-1/4	130	82	70	54
	16N48-24-24	40	1-1/2	-24	38.1	1-1/2	139	101	104	64
	16N48-32-32	50	2	-32	50.8	2	172	124	115	79
	16N48-32-32	50	2	-32	50.8	2	172	124	115	79

To select corresponding half-flange and O-ring see Section Eb.

Approved **fitting series** for hose types:

Also available in stainless steel. Details can be found in CAT 4400.1/UK

46 or 48	441 441RH 461LT 462 462ST
46	463 492 492ST 692 692TWIN
48	301SN 301TC 302 304 351TC 421RH 421SN 421WC 422 426 436 451 451TC 471TC 472TC 477 477ST 493 811 881



# JC

## Female ORFS Swivel – Straight Short

ISO 12151-1 – SWSA  
SAE J516 – ORFS

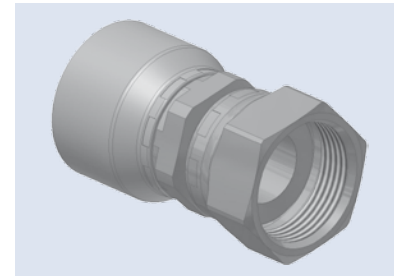
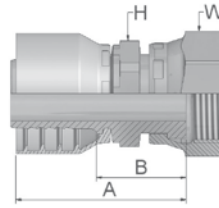

XXXXX-XX-XX Part Number		Hose I.D.				Thread UNF	A	B	H	W
46	48	DN	Inch	Size	mm		mm	mm	mm	mm
1JC46-4-4	1JC48-4-4	6	1/4	-4	6.3	9/16x18	46	22	14	17
1JC46-6-4	1JC48-6-4	6	1/4	-4	6.3	11/16x16	45	23	17	22
1JC46-8-4	1JC48-8-4	6	1/4	-4	6.3	13/16x16	45	22	19	24
1JC46-6-5	1JC48-6-5	8	5/16	-5	7.9	11/16x16	47	23	17	22
1JC46-4-6	1JC48-4-6	10	3/8	-6	9.5	9/16x18	42	19	17	17
1JC46-6-6	1JC48-6-6	10	3/8	-6	9.5	11/16x16	43	21	17	22
1JC46-8-6	1JC48-8-6	10	3/8	-6	9.5	13/16x16	45	22	19	24
1JC46-6-8	1JC48-6-8	12	1/2	-8	12.7	11/16x16	44	20	17	22
1JC46-8-8	1JC48-8-8	12	1/2	-8	12.7	13/16x16	46	22	22	24
1JC46-10-8	1JC48-10-8	12	1/2	-8	12.7	1x14	48	24	24	30
1JC46-12-8	1JC48-12-8	12	1/2	-8	12.7	1-3/16x12	52	29	30	36
1JC46-8-10	1JC48-8-10	16	5/8	-10	15.9	13/16x16	47	22	22	24
1JC46-10-10	1JC48-10-10	16	5/8	-10	15.9	1x14	51	26	24	30
1JC46-12-10	1JC48-12-10	16	5/8	-10	15.9	1-3/16x12	54	28	30	36
1JC46-10-12	1JC48-10-12	20	3/4	-12	19.1	1x14	54	28	24	30
1JC46-12-12	1JC48-12-12	20	3/4	-12	19.1	1-3/16x12	55	29	30	36
1JC46-16-12	1JC48-16-12	20	3/4	-12	19.1	1-7/16x12	59	33	36	41
1JC46-12-16	1JC48-12-16	25	1	-16	25.4	1-3/16x12	60	30	32	36
1JC46-16-16	1JC48-16-16	25	1	-16	25.4	1-7/16x12	63	33	36	41
1JC46-20-16	1JC48-20-16	25	1	-16	25.4	1-11/16x12	62	32	41	50
1JC46-20-20		32	1-1/4	-20	31.8	1-11/16x12	71	33	41	50
	1JC48-20-20	32	1-1/4	-20	31.8	1-11/16x12	85	36	50	50

Approved fitting series for hose types:



Also available in stainless steel. Details can be found in CAT 4400.1/UK

46	or	48	441	441RH	461LT	462	462ST													
46	463	492	492ST	692	692TWIN															
48	301SN	301TC	302	304	351TC	421RH	421SN	421WC	422	426	436	451	451TC	471TC	472TC	477	477ST	493	811	881

# JS ORFS Swivel Female (Long)

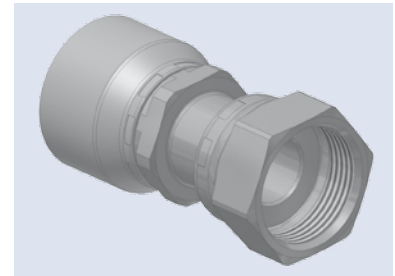
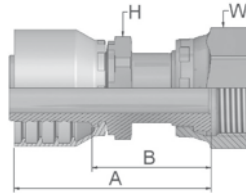
ISO 12151-1-SWSB  
SAE J516 – ORFS

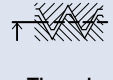

XXXXX-XX-XX Part Number		 Hose I.D.				 Thread UNF	A	B	 H	 W
46	48	DN	Inch	Size	mm		mm	mm	mm	mm
1JS46-4-4	1JS48-4-4	6	1/4	-4	6.3	9/16x18	51	29	14	17
1JS46-6-4	1JS48-6-4	6	1/4	-4	6.3	11/16x16	54	31	17	22
1JS46-6-5	1JS48-6-5	8	5/16	-5	7.9	11/16x16	55	31	17	22
1JS46-4-6	1JS48-4-6	10	3/8	-6	9.5	9/16x18	53	31	14	17
1JS46-6-6	1JS48-6-6	10	3/8	-6	9.5	11/16x16	52	29	17	22
1JS46-8-6	1JS48-8-6	10	3/8	-6	9.5	13/16x16	58	35	19	24
1JS46-6-8	1JS48-6-8	12	1/2	-8	12.7	11/16x16	52	29	17	22
1JS46-8-8	1JS48-8-8	12	1/2	-8	12.7	13/16x16	57	33	22	24
1JS46-10-8	1JS48-10-8	12	1/2	-8	12.7	1x14	63	39	24	30
1JS46-10-10	1JS48-10-10	16	5/8	-10	15.9	1x14	65	39	24	30
1JS46-12-10	1JS48-12-10	16	5/8	-10	15.9	1-3/16x12	70	45	30	36
1JS46-10-12	1JS48-10-12	20	3/4	-12	19.1	1x14	65	39	24	30
1JS46-12-12	1JS48-12-12	20	3/4	-12	19.1	1-3/16x12	71	45	30	36
1JS46-16-12	1JS48-16-12	20	3/4	-12	19.1	1-7/16x12	73	47	36	41
1JS46-16-16	1JS48-16-16	25	1	-16	25.4	1-7/16x12	76	46	36	41
1JS46-20-20		32	1-1/4	-20	31.8	1-11/16x12	88	50	41	50
	1JS48-20-20	32	1-1/4	-20	31.8	1-11/16x12	102	54	46	50
	1JS48-24-24	40	1-1/2	-24	38.1	2x12	100	62	50	60

Approved **fitting series** for hose types:

Also available in stainless steel. Details can be found in CAT 4400.1/UK

46 or 48	441 441RH 461LT 462 462ST
46	463 492 492ST 692 692TWIN
48	301SN 301TC 302 304 351TC 421RH 421SN 421WC 422 426 436 451 451TC 471TC 472TC 477 477ST 493 811 881

# J7

## Female ORFS – Swivel 45° Elbow

ISO 12151-1 – SWE 45°  
SAE J516 – ORFS 45°

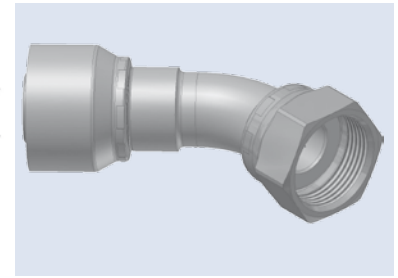
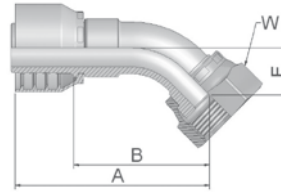

XXXXX-XX-XX Part Number		Hose I.D.				Thread UNF	A	B	E	W
46	48	DN	Inch	Size	mm		mm	mm	mm	mm
1J746-4-4	1J748-4-4	6	1/4	-4	6.3	9/16x18	52	28	10	17
1J746-6-4	1J748-6-4	6	1/4	-4	6.3	11/16x16	53	30	11	22
1J746-8-4	1J748-8-4	6	1/4	-4	6.3	13/16x16	59	34	15	24
1J746-6-5	1J748-6-5	8	5/16	-5	7.9	11/16x16	56	32	11	22
1J746-6-6	1J748-6-6	10	3/8	-6	9.5	11/16x16	54	31	11	22
1J746-8-6	1J748-8-6	10	3/8	-6	9.5	13/16x16	59	36	15	24
1J746-6-8	1J748-6-8	12	1/2	-8	12.7	11/16x16	57	33	11	22
1J746-8-8	1J748-8-8	12	1/2	-8	12.7	13/16x16	61	38	15	24
1J746-10-8	1J748-10-8	12	1/2	-8	12.7	1x14	65	41	16	30
1J746-12-8	1J748-12-8	12	1/2	-8	12.7	1-3/16x12	77	53	21	36
1J746-10-10	1J748-10-10	16	5/8	-10	15.9	1x14	67	42	16	30
1J746-12-10	1J748-12-10	16	5/8	-10	15.9	1-3/16x12	80	55	21	36
1J746-10-12	1J748-10-12	20	3/4	-12	19.1	1x14	73	47	16	30
1J746-12-12	1J748-12-12	20	3/4	-12	19.1	1-3/16x12	83	57	21	36
1J746-16-12	1J748-16-12	20	3/4	-12	19.1	1-7/16x12	94	68	24	41
1J746-12-16	1J748-12-16	25	1	-16	25.4	1-3/16x12	91	61	21	36
1J746-16-16	1J748-16-16	25	1	-16	25.4	1-7/16x12	99	69	24	41
1J746-20-16	1J748-20-16	25	1	-16	25.4	1-11/16x12	101	71	25	50
1J746-20-20		32	1-1/4	-20	31.8	1-11/16x12	124	86	26	50
	1J748-20-20	32	1-1/4	-20	31.8	1-11/16x12	130	82	27	50
	1J748-24-24	40	1-1/2	-24	38.1	2x12	148	110	40	60

Approved fitting series for hose types:





Also available in stainless steel. Details can be found in CAT 4400.1/UK

46	or	48	441	441RH	461LT	462	462ST													
46	463	492	492ST	692	692TWIN															
48	301SN	301TC	302	304	351TC	421RH	421SN	421WC	422	426	436	451	451TC	471TC	472TC	477	477ST	493	811	881

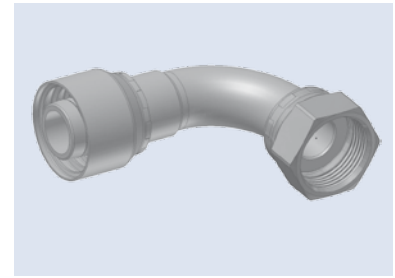
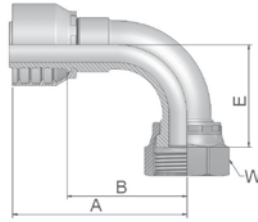
# J9 Female ORFS – Swivel 90° Elbow – Short Drop

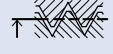
ISO 12151-1 – SWES  
SAE J516 – ORFS 90°





XXXXX-XX-XX		 Hose I.D.				 Thread UNF	A	B	E	 W
Part Number		DN	Inch	Size	mm		mm	mm	mm	mm
 46	 48									
1J946-4-4	1J948-4-4	6	1/4	-4	6.3	9/16x18	48	24	21	17
1J946-6-4	1J948-6-4	6	1/4	-4	6.3	11/16x16	51	27	23	22
1J946-8-4	1J948-8-4	6	1/4	-4	6.3	13/16x16	50	26	29	24
1J946-6-5	1J948-6-5	8	5/16	-5	7.9	11/16x16	53	29	23	22
1J946-4-6	1J948-4-6	10	3/8	-6	9.5	9/16x18	47	24	21	17
1J946-6-6	1J948-6-6	10	3/8	-6	9.5	11/16x16	52	29	23	22
1J946-8-6	1J948-8-6	10	3/8	-6	9.5	13/16x16	53	30	29	24
1J946-6-8	1J948-6-8	12	1/2	-8	12.7	11/16x16	53	29	23	22
1J946-8-8	1J948-8-8	12	1/2	-8	12.7	13/16x16	55	32	29	24
1J946-10-8	1J948-10-8	12	1/2	-8	12.7	1x14	66	43	32	30
1J946-12-8	1J948-12-8	12	1/2	-8	12.7	1-3/16x12	58	34	48	36
1J946-10-10	1J948-10-10	16	5/8	-10	15.9	1x14	66	40	32	30
1J946-12-10	1J948-12-10	16	5/8	-10	15.9	1-3/16x12	71	45	48	36
1J946-10-12	1J948-10-12	20	3/4	-12	19.1	1x14	69	43	32	30
1J946-12-12	1J948-12-12	20	3/4	-12	19.1	1-3/16x12	82	54	48	36
1J946-16-12	1J946-16-12	20	3/4	-12	19.1	1-7/16x12	88	62	56	41
1J946-12-16	1J948-12-16	25	1	-16	25.4	1-3/16x12	88	58	48	36
1J946-16-16	1J948-16-16	25	1	-16	25.4	1-7/16x12	96	66	56	41
1J946-20-16	1J948-20-16	25	1	-16	25.4	1-11/16x12	104	74	64	50
1J946-16-20		32	1-1/4	-20	31.8	1-7/16x12	107	69	56	41
1J946-20-20		32	1-1/4	-20	31.8	1-11/16x12	124	86	64	50
	1J948-20-20	32	1-1/4	-20	31.8	1-11/16x12	130	83	64	50
	1J948-24-24	40	1-1/2	-24	38.1	2x12	140	102	82	60

Approved **fitting series** for hose types:

Also available in stainless steel. Details can be found in CAT 4400.1/UK

 46 or  48 441 441RH 461LT 462 462ST

 46 463 492 492ST 692 692TWIN

 48 301SN 301TC 302 304 351TC 421RH 421SN 421WC 422 426 436 451 451TC 471TC 472TC 477 477ST 493 811 881

# J1 Female ORFS – Swivel 90° Elbow – Long Drop

ISO 12151-1 – SWEL  
SAE J 516 – ORFS 90° L

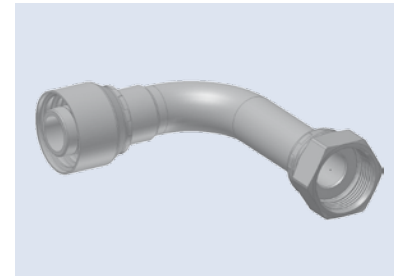
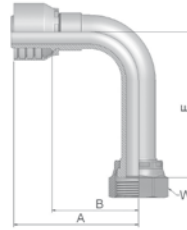

XXXXX-XX-XX Part Number		Hose I.D.				Thread UNF	A	B	E	W
46	48	DN	Inch	Size	mm		mm	mm	mm	mm
1J146-4-4	1J148-4-4	6	1/4	-4	6.3	9/16x18	58	35	46	17
1J146-6-4	1J148-6-4	6	1/4	-4	6.3	11/16x16	60	36	54	22
1J146-6-6	1J148-6-6	10	3/8	-6	9.5	11/16x16	58	35	54	22
1J146-8-6	1J148-8-6	10	3/8	-6	9.5	13/16x16	59	37	64	24
1J146-8-8	1J148-8-8	12	1/2	-8	12.7	13/16x16	61	37	64	24
1J146-10-8	1J148-10-8	12	1/2	-8	12.7	1x14	66	42	70	30
1J146-10-10	1J148-10-10	16	5/8	-10	15.9	1x14	65	40	70	30
1J146-12-12	1J148-12-12	20	3/4	-12	19.1	1-3/16x12	80	54	96	36
1J146-16-16	1J148-16-16	25	1	-16	25.4	1-7/16x12	95	66	114	41

# J5 Female ORFS – Swivel 90° Elbow – Medium Drop

ISO 12151-1 – SWEM – ORFS 90° M

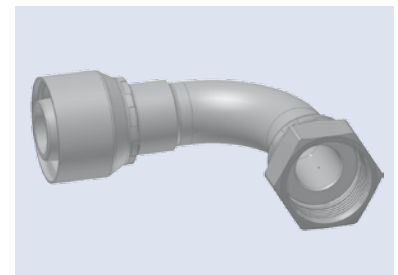
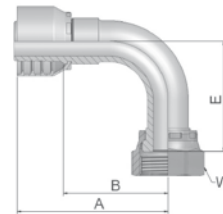

XXXXX-XX-XX Part Number		Hose I.D.				Thread UNF	A	B	E	W
46	48	DN	Inch	Size	mm		mm	mm	mm	mm
1J546-4-4	1J548-4-4	6	1/4	-4	6.3	9/16x18	59	35	32	17
1J546-6-4	1J548-6-4	6	1/4	-4	6.3	11/16x16	62	38	38	22
1J546-6-6	1J548-6-6	10	3/8	-6	9.5	11/16x16	58	35	38	22
1J546-8-6	1J548-8-6	10	3/8	-6	9.5	13/16x16	60	37	41	24
1J546-8-8	1J548-8-8	12	1/2	-8	12.7	13/16x16	60	37	41	24
1J546-10-8	1J548-10-8	12	1/2	-8	12.7	1x14	66	43	47	30
1J546-10-10	1J548-10-10	16	5/8	-10	15.9	1x14	65	40	47	30
1J546-12-12	1J548-12-12	20	3/4	-12	19.1	1-3/16x12	80	54	58	36

Approved fitting series for hose types:

Also available in stainless steel. Details can be found in CAT 4400.1/UK





46	or	48	441	441RH	461LT	462	462ST													
46	463	492	492ST	692	692TWIN															
48	301SN	301TC	302	304	351TC	421RH	421SN	421WC	422	426	436	451	451TC	471TC	472TC	477	477ST	493	811	881

**JM**

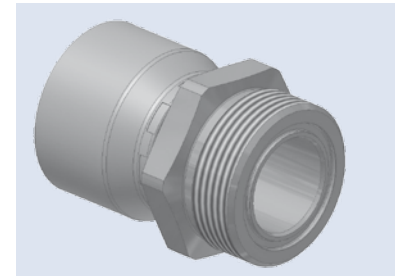
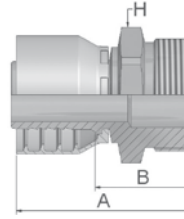
**ORFS Male**

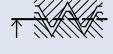
ISO 12151-1-S – SAE J516



XXXXX-XX-XX		 Hose I.D.				 Thread UNF	A	B	 H
Part Number		DN	Inch	Size	mm		mm	mm	mm
 46	 48								
1JM46-4-4	1JM48-4-4	6	1/4	-4	6.3	9/16x18	44	22	17
1JM46-6-4	1JM48-6-4	6	1/4	-4	6.3	11/16x16	46	24	19
1JM46-6-5	1JM48-6-5	8	5/16	-5	7.9	11/16x16	53	26	19
1JM46-6-6	1JM48-6-6	10	3/8	-6	9.5	11/16x16	47	24	19
1JM46-8-6	1JM48-8-6	10	3/8	-6	9.5	13/16x16	50	27	22
1JM46-8-8	1JM48-8-8	12	1/2	-8	12.7	13/16x16	51	27	22
1JM46-10-8	1JM48-10-8	12	1/2	-8	12.7	1x14	55	32	27
1JM46-10-10	1JM48-10-10	16	5/8	-10	15.9	1x14	57	32	27
1JM46-12-10	1JM48-12-10	16	5/8	-10	15.9	1-3/16x12	59	34	32
1JM46-12-12	1JM48-12-12	20	3/4	-12	19.1	1-3/16x12	61	35	32
1JM46-16-12	1JM48-16-12	20	3/4	-12	19.1	1-7/16x12	64	38	41
1JM46-16-16	1JM48-16-16	25	1	-16	25.4	1-7/16x12	67	37	41
1JM46-20-16	1JM48-20-16	25	1	-16	25.4	1-11/16x12	66	36	46
	1JM48-20-20	32	1-1/4	-20	31.8	1-11/16x12	85	37	46





To select corresponding O-ring see Section Eb.

**JD**

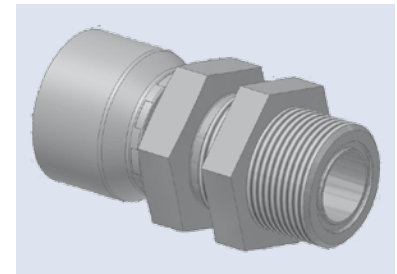
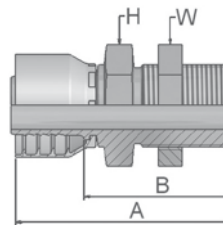
**Male ORFS  
Bulkhead with Locknut  
Straight (with O-ring)**

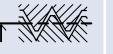
ISO 12151-1 – SAE J516





XXXXX-XX-XX		 Hose I.D.				 Thread UNF	A	B	 H	 W
Part Number		DN	Inch	Size	mm		mm	mm	mm	mm
 46	 48									
1JD46-4-4	1JD48-4-4	6	1/4	-4	6.3	9/16x18	72	48	22	22
1JD46-6-6	1JD48-6-6	10	3/8	-6	9.5	11/16x16	74	51	27	27
1JD46-8-8	1JD48-8-8	12	1/2	-8	12.7	13/16x16	79	56	30	30
1JD46-10-10	1JD48-10-10	16	5/8	-10	15.9	1x14	86	60	32	36
1JD46-12-12	1JD48-12-12	20	3/4	-12	19.1	1-3/16x12	89	63	36	38
1JD46-16-16	1JD48-16-16	25	1	-16	25.4	1-7/16x12	94	64	46	46

To select corresponding O-ring see Section Eb.

Approved **fitting series** for hose types:

Also available in stainless steel. Details can be found in CAT 4400.1/UK

 46 or  48 441 441RH 461LT 462 462ST

 46 463 492 492ST 692 692TWIN

 48 301SN 301TC 302 304 351TC 421RH 421SN 421WC 422 426 436 451 451TC 471TC 472TC 477 477ST 493 811 881

## FU Female BSP Parallel Pipe Swivel – Straight (30° Flare)

ISO 228-1 – JIS B8363 – GUI

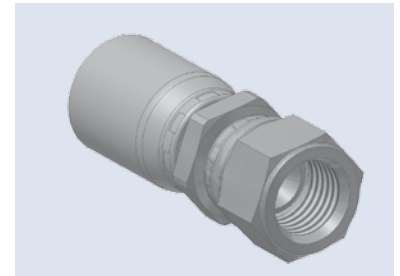
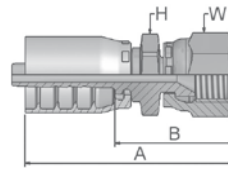

XXXXX-XX-XX Part Number		Hose I.D.				Thread BSP	A mm	B mm	H mm	W mm
46	48	DN	Inch	Size	mm					
1FU46-4-4	1FU48-4-4	6	1/4	-4	6.3	1/4x19	50	32	19	19
1FU46-6-6	1FU48-6-6	10	3/8	-6	9.5	3/8x19	58	35	24	22
1FU46-12-12	1FU48-12-12	20	3/4	-12	19.1	3/4x14	71	45	36	36
1FU46-16-16	1FU48-16-16	25	1	-16	25.4	1x11	76	46	41	41

## GU Female BSP Parallel Pipe Swivel – Straight (60° Cone)

ISO 228-1 – JIS B8363 – GUO

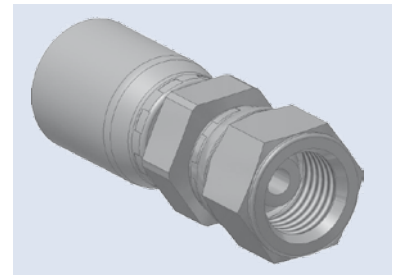
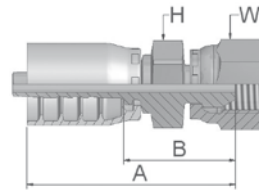

XXXXX-XX-XX Part Number		Hose I.D.				Thread BSP	A mm	B mm	H mm	W mm
46	48	DN	Inch	Size	mm					
1GU46-4-4	1GU48-4-4	6	1/4	-4	6.3	1/4x19	51	27	19	19
1GU46-6-6	1GU48-6-6	10	3/8	-6	9.5	3/8x19	58	35	22	22
1GU46-8-8	1GU48-8-8	12	1/2	-8	12.7	1/2x14	55	32	27	27

Approved **fitting series** for hose types:









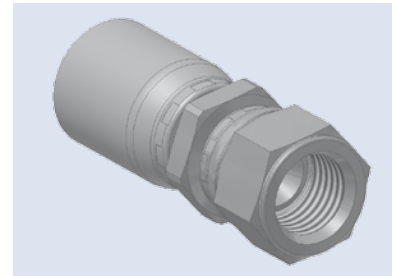
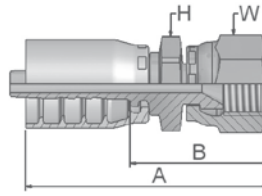

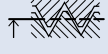
Also available in stainless steel. Details can be found in CAT 4400.1/UK

46	or	48	441	441RH	461LT	462	462ST													
46	463	492	492ST	692	692TWIN															
48	301SN	301TC	302	304	351TC	421RH	421SN	421WC	422	426	436	451	451TC	471TC	472TC	477	477ST	493	811	881

## MU Female Metric – Swivel Straight (30° Flare)

JIS B8363 – MU









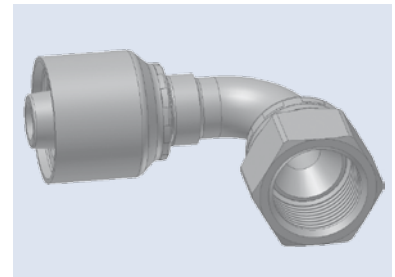
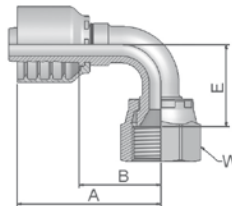

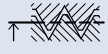
XXXXX-XX-XX		 Hose I.D.				 Thread metric	A	B	 H	 W
Part Number		DN	Inch	Size	mm		mm	mm	mm	mm
 1MU46-4-4	 1MU48-4-4	6	1/4	-4	6.3	M14x1.5	45	21	19	19
 1MU46-6-4	 1MU48-6-4	6	1/4	-4	6.3	M18x1.5	57	33	24	24
 1MU46-6-6	 1MU48-6-6	10	3/8	-6	9.5	M18x1.5	59	36	24	24
 1MU46-8-8	 1MU48-8-8	12	1/2	-8	12.7	M22x1.5	64	40	27	27

## MZ Female Metric – Swivel 90° Elbow (30° Flare)



JIS B8363





XXXXX-XX-XX		 Hose I.D.				 Thread metric	A	B	E	 W
Part Number		DN	Inch	Size	mm		mm	mm	mm	mm
 1MZ46-4-4	 1MZ48-4-4	6	1/4	-4	6.3	M14x1.5	48	24	23	19
 1MZ46-6-6	 1MZ48-6-6	10	3/8	-6	9.5	M18x1.5	51	28	29	24
 1MZ46-8-8	 1MZ48-8-8	12	1/2	-8	12.7	M22x1.5	55	31	31	27

Approved **fitting series** for hose types:

Also available in stainless steel. Details can be found in CAT 4400.1/UK

 **46** or  **48** 441 441RH 461LT 462 462ST

 **46** 463 492 492ST 692 692TWIN

 **48** 301SN 301TC 302 304 351TC 421RH 421SN 421WC 422 426 436 451 451TC 471TC 472TC 477 477ST 493 811 881



## FG Male French Gas Series Rigid – Straight (24° Cone)

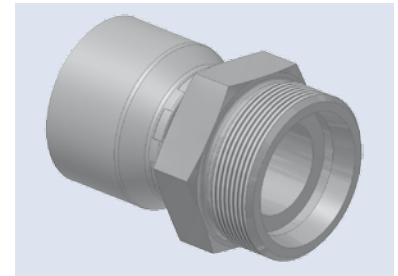
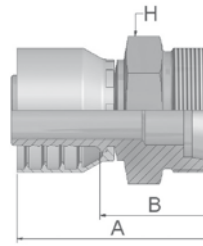

XXXXX-XX-XX Part Number		Hose I.D.				Thread metric	Tube O.D. mm	A mm	B mm	H mm
46	48	DN	Inch	Size	mm					
1FG46-13-5	1FG48-13-5	8	5/16	-5	7.9	M20x1.5	13	53	29	22
1FG46-13-6	1FG48-13-6	10	3/8	-6	9.5	M20x1.5	13	52	30	22
1FG46-17-8	1FG48-17-8	12	1/2	-8	12.7	M24x1.5	17	51	27	24
1FG46-21-10	1FG48-21-10	16	5/8	-10	15.9	M30x1.5	21	58	32	30
1FG46-27-12	1FG48-27-12	20	3/4	-12	19.1	M36x1.5	27	60	34	36
1FG46-33-16	1FG48-33-16	25	1	-16	25.4	M45x1.5	33	69	40	46

## F2 Female French Gas Series Swivel – 90° Elbow

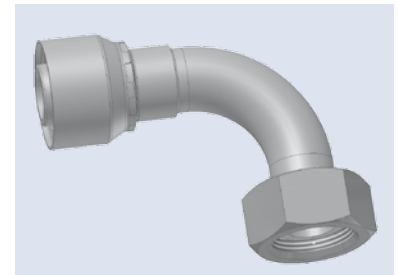
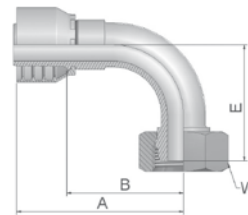

XXXXX-XX-XX Part Number		Hose I.D.				Thread metric	Tube O.D. mm	A mm	B mm	E mm	W mm
46	48	DN	Inch	Size	mm						
1F246-13-5	1F248-13-5	8	5/16	-5	7.9	M20x1.5	13	59	35	30	24
1F246-13-6	1F248-13-6	10	3/8	-6	9.5	M20x1.5	13	60	38	33	24
1F246-17-8	1F248-17-8	12	1/2	-8	12.7	M24x1.5	17	61	37	43	30
1F246-21-10	1F248-21-10	16	5/8	-10	15.9	M30x1.5	21	71	46	45	36

Approved **fitting series** for hose types:

Also available in stainless steel. Details can be found in CAT 4400.1/UK

46	or	48	441	441RH	461LT	462	462ST													
46	463	492	492ST	692	692TWIN															
48	301SN	301TC	302	304	351TC	421RH	421SN	421WC	422	426	436	451	451TC	471TC	472TC	477	477ST	493	811	881

## F4 Female French Gas Series Swivel – Straight (Ball Nose)

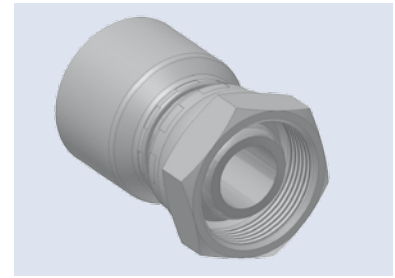
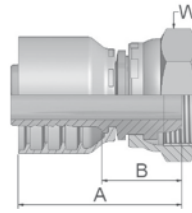

XXXXX-XX-XX Part Number		Hose I.D.				Thread metric	Tube O.D. mm	A mm	B mm	W mm
46	48	DN	Inch	Size	mm					
1F446-13-4	1F448-13-4	6	1/4	-4	6.3	M20x1.5	13	48	24	24
1F446-13-5	1F448-13-5	8	5/16	-5	7.9	M20x1.5	13	48	24	24
1F446-13-6	1F448-13-6	10	3/8	-6	9.5	M20x1.5	13	45	22	24
1F446-17-8	1F448-17-8	12	1/2	-8	12.7	M24x1.5	17	49	25	30
1F446-21-10	1F448-21-10	16	5/8	-10	15.9	M30x1.5	21	50	25	36
1F446-27-12	1F448-27-12	20	3/4	-12	19.1	M36x1.5	26	59	33	46
1F446-33-16	1F448-33-16	25	1	-16	25.4	M45x1.5	33	63	33	55

## F6 French Male Metric Series (24° Cone)

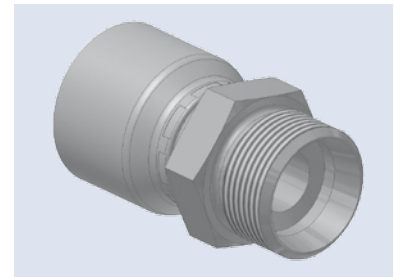
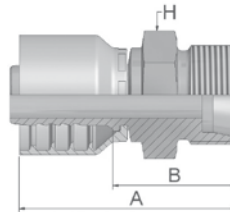

XXXXX-XX-XX Part Number		Hose I.D.				Thread metric	Tube O.D. mm	A mm	B mm	H mm
46	48	DN	Inch	Size	mm					
1F646-14-6	1F648-14-6	10	3/8	-6	9.5	M20x1.5	14	50	27	22
1F646-20-10	1F648-20-10	16	5/8	-10	15.9	M27x1.5	20	59	33	30

Approved **fitting series** for hose types:

Also available in stainless steel. Details can be found in CAT 4400.1/UK

46 or 48 441 441RH 461LT 462 462ST

46 463 492 492ST 692 692TWIN

48 301SN 301TC 302 304 351TC 421RH 421SN 421WC 422 426 436 451 451TC 471TC 472TC 477 477ST 493 811 881

## F9 French Female Metric Series Swivel – (Ball Nose)

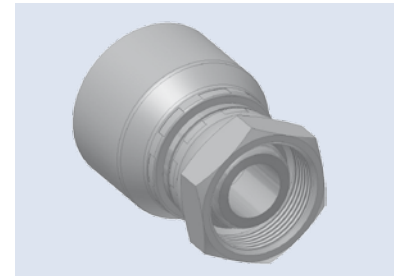
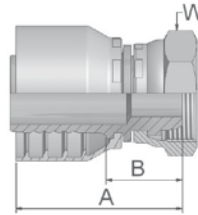

XXXXX-XX-XX Part Number		Hose I.D.				Thread metric	Tube O.D. mm	A mm	B mm	W mm
46	48	DN	Inch	Size	mm					
1F946-6-4	1F948-6-4	6	1/4	-4	6.3	M12x1	6	44	20	14
1F946-10-4	1F948-10-4	6	1/4	-4	6.3	M16x1.5	10	46	22	19
1F946-14-6	1F948-14-6	10	3/8	-6	9.5	M20x1.5	14	45	22	24
1F946-20-10	1F948-20-10	16	5/8	-10	15.9	M27x1.5	20	50	25	32
1F946-22-12	1F948-22-12	20	3/4	-12	19.1	M30x1.5	22	54	28	36
1F946-25-12	1F948-25-12	20	3/4	-12	19.1	M33x1.5	25	56	30	41
1F946-30-16	1F948-30-16	25	1	-16	25.4	M39x1.5	30	62	32	50

## FA Metric Male for Agriculture Valves

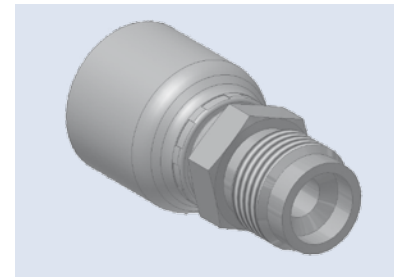
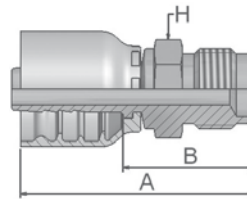

XXXXX-XX-XX Part Number		Hose I.D.				Thread metric	A mm	B mm	H mm
46	48	DN	Inch	Size	mm				
1FA46-12-5	1FA48-12-5	8	5/16	-5	7.9	M18x1.5	53	29	19
1FA46-12-6	1FA48-12-6	10	3/8	-6	9.5	M18x1.5	52	29	19
1FA46-12-8	1FA48-12-8	12	1/2	-8	12.7	M18x1.5	53	29	19

Approved **fitting series** for hose types:

Also available in stainless steel. Details can be found in CAT 4400.1/UK

46	or	48	441	441RH	461LT	462	462ST													
46	463	492	492ST	692	692TWIN															
48	301SN	301TC	302	304	351TC	421RH	421SN	421WC	422	426	436	451	451TC	471TC	472TC	477	477ST	493	811	881

## CW Power Cleaner Connection

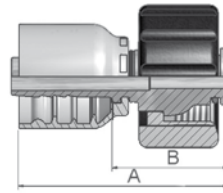

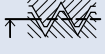
XXXXX-XX-XX		 Hose I.D.				 Thread metric	Tube O.D.	A	B
Part Number		DN	Inch	Size	mm		mm	mm	mm
46	48								
1CW46-15-4	1CW48-15-4	6	1/4	-4	6.3	M22x1.5	15	53	29
1CW46-15-5	1CW48-15-5	8	5/16	-5	7.9	M22x1.5	15	53	29
1CW46-15-6	1CW48-15-6	10	3/8	-6	9.5	M22x1.5	15	52	29
1CW46-15-8	1CW48-15-8	12	1/2	-8	12.7	M22x1.5	15	53	29

Rubber hand grip Part-No. WKS-X-XXX in black or blue please find on page Eb-16.

## NW Female Kärcher Metric Cleaning Hose Fitting Swivel – Straight

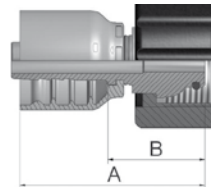

XXXXX-XX-XX		 Hose I.D.				 Thread metric	A	B
Part Number		DN	Inch	Size	mm		mm	mm
46	48							
1NW46-15-4	1NW48-15-4	6	1/4	-4	6.3	M22x1.5	52	29
1NW46-15-5	1NW48-15-5	8	5/16	-5	7.9	M22x1.5	52	29
1NW46-15-6	1NW48-15-6	10	3/8	-6	9.5	M22x1.5	48	25

Rubber hand grip Part-No. WKS-X-XXX in black or blue please find on page Eb-16.

Approved **fitting series** for hose types:

Also available in stainless steel. Details can be found in CAT 4400.1/UK



**46** or **48** 441 441RH 461LT 462 462ST

**46** 463 492 492ST 692 692TWIN

**48** 301SN 301TC 302 304 351TC 421RH 421SN 421WC 422 426 436 451 451TC 471TC 472TC 477 477ST 493 811 881

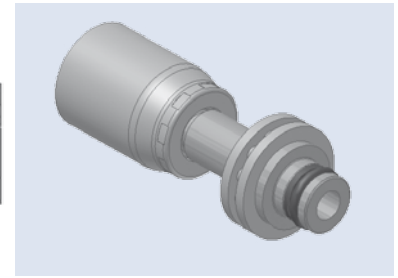
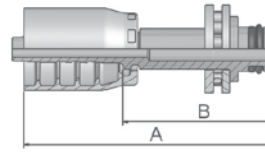
**PW** **Male Kärcher  
Metric Cleaning Hose Fitting  
Rigid – Straight**







XXXXX-XX-XX		 Hose I.D.				Tube O.D.	A	B
Part Number		DN	Inch	Size	mm	mm	mm	mm
								
1PW46-10-4	1PW48-10-4	6	1/4	-4	6.3	10	60	36
1PW46-11-4	1PW48-11-4	6	1/4	-4	6.3	11	61	37
1PW46-10-5	1PW48-10-5	8	5/16	-5	7.9	10	60	36
1PW46-11-5	1PW48-11-5	8	5/16	-5	7.9	11	61	37
1PW46-10-6	1PW48-10-6	10	3/8	-6	9.5	10	60	37

Rubber hand grip Part-No. WKS-X-XXX in black or blue please find on page Eb-16.

Approved **fitting series** for hose types:

Also available in stainless steel. Details can be found in CAT 4400.1/UK

	<b>46</b>	or		<b>48</b>	441 441RH 461LT 462 462ST
	<b>46</b>	463 492 492ST 692 692TWIN			
	<b>48</b>	301SN 301TC 302 304 351TC 421RH 421SN 421WC 422 426 436 451 451TC 471TC 472TC 477 477ST 493 811 881			

## DK Male Metric L – Rigid Bulkhead with Locknut (24° Cone)

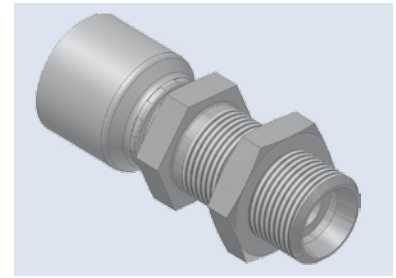
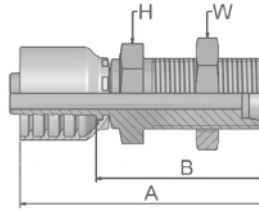

XXXXX-XX-XX Part Number		Hose I.D.				Thread metric	A mm	B mm	H mm	W mm
46	48	DN	Inch	Size	mm					
1DK46-10-5	1DK48-10-5	8	5/16	-5	7.9	M16x1.5	71	48	22	22
1DK46-15-10	1DK48-15-10	16	5/8	-10	15.9	M22x1.5	81	56	27	30
1DK46-18-10	1DK48-18-10	16	5/8	-10	15.9	M26x1.5	85	60	36	36

## DX Female Metric Swivel (M27x2) O-Ring Light Series

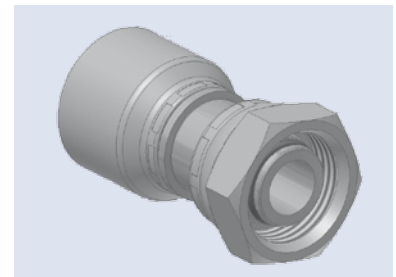
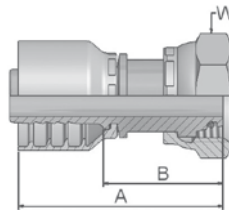

XXXXX-XX-XX Part Number		Hose I.D.				Thread metric	A mm	B mm	W mm
46	48	DN	Inch	Size	mm				
1DX46-18-10	1DX48-18-10	16	5/8	-10	15.9	M27x2	61	36	32

Approved **fitting series** for hose types:

Also available in stainless steel. Details can be found in CAT 4400.1/UK

46	or	48	441	441RH	461LT	462	462ST													
46	463	492	492ST	692	692TWIN															
48	301SN	301TC	302	304	351TC	421RH	421SN	421WC	422	426	436	451	451TC	471TC	472TC	477	477ST	493	811	881

## EN UPTC – Male Straight

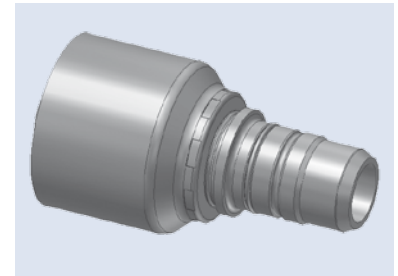
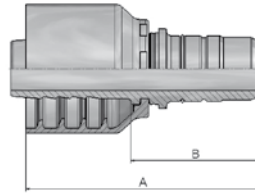

XXXXX-XX-XX Part Number		Hose I.D.				Tube O.D.	A	B
46	48	DN	Inch	Size	mm	mm	mm	mm
1EN46-8-4	1EN48-8-4	6	1/4	-4	6.3	8	49	26
1EN46-10-5	1EN48-10-5	8	5/16	-5	7.9	10	50	26
1EN46-12-6	1EN48-12-6	10	3/8	-6	9.5	12	50	27
1EN46-15-8	1EN48-15-8	12	1/2	-8	12.7	15	53	29
1EN46-18-10	1EN48-18-10	16	5/8	-10	15.9	18	56	31
1EN46-22-12	1EN48-22-12	20	3/4	-12	19.1	22	58	33

## EU UPTC – Male 45° Elbow

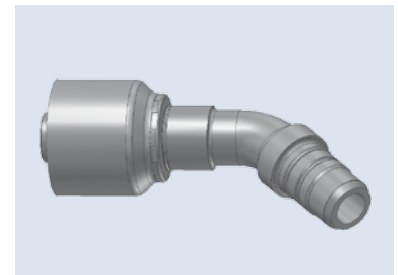
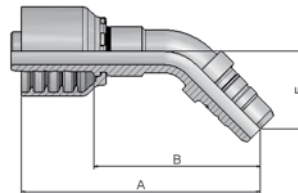

XXXXX-XX-XX Part Number		Hose I.D.				Tube O.D.	A	B	E
46	48	DN	Inch	Size	mm	mm	mm	mm	mm
1EU46-8-4	1EU48-8-4	6	1/4	-4	6.3	8	66	43	23
1EU46-10-5	1EU48-10-5	8	5/16	-5	7.9	10	68	45	23
1EU46-12-6	1EU48-12-6	10	3/8	-6	9.5	12	71	48	23
1EU46-15-8	1EU48-15-8	12	1/2	-8	12.7	15	78	54	25
1EU46-18-10	1EU48-18-10	16	5/8	-10	15.9	18	84	59	32
1EU46-22-12	1EU48-22-12	20	3/4	-12	19.1	22	95	69	33

Approved **fitting series** for hose types:

Also available in stainless steel. Details can be found in CAT 4400.1/UK

46	or	48	441	441RH	461LT	462	462ST													
46	463	492	492ST	692	692TWIN															
48	301SN	301TC	302	304	351TC	421RH	421SN	421WC	422	426	436	451	451TC	471TC	472TC	477	477ST	493	811	881

**ET** **UPTC – Male**  
**90° Elbow**

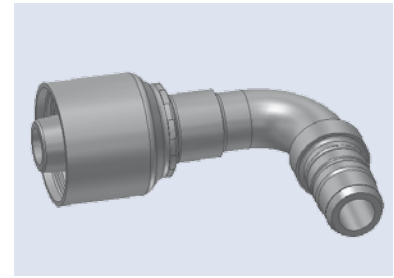
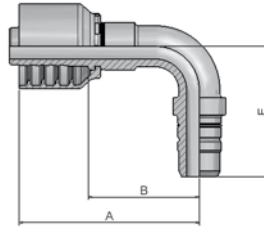

XXXXX-XX-XX Part Number		 Hose I.D.				Tube O.D.	A	B	E
46	48	DN	Inch	Size	mm	mm	mm	mm	mm
1ET46-8-4	1ET48-8-4	6	1/4	-4	6.3	8	59	36	39
1ET46-10-5	1ET48-10-5	8	5/16	-5	7.9	10	58	35	39
1ET46-12-6	1ET48-12-6	10	3/8	-6	9.5	12	57	34	40
1ET46-15-8	1ET48-15-8	12	1/2	-8	12.7	15	61	38	45
1ET46-18-10	1ET48-18-10	16	5/8	-10	15.9	18	65	39	57
1ET46-22-12	1ET48-22-12	20	3/4	-12	19.1	22	80	54	64

Approved **fitting series** for hose types:

Also available in stainless steel. Details can be found in CAT 4400.1/UK

46 or 48	441 441RH 461LT 462 462ST
46	463 492 492ST 692 692TWIN
48	301SN 301TC 302 304 351TC 421RH 421SN 421WC 422 426 436 451 451TC 471TC 472TC 477 477ST 493 811 881





aerospace  
climate control  
electromechanical  
filtration  
fluid & gas handling  
hydraulics  
pneumatics  
process control  
sealing & shielding



# Hydraulic Hoses, Fittings and Equipment

High pressure



ENGINEERING YOUR SUCCESS.

# High-Pressure Hoses and Fittings

Three systems for heavy duty performers

## Multispiral Parkrimp *No-Skive*

Crimpable with  
Parkrimp System



## Compact Spiral Interlock *No-Skive*

Crimpable with  
Parkrimp System



## ParLock Interlock Skive

Crimpable with  
adjustable crimpers



## Applications

The definitive hose range for all  
high pressure applications



**Parkrimp crimpers**  
for *No-Skive* one-piece fittings



KarryKrimp® 2

KarryKrimp® 2 Bench Mount

Parkrimp 2®

**Adjustable crimpers**  
for two-piece ParLock fittings



TH8E-530

TH8E-380-BM

TH8-800-BM



**Parkrimp *No-Skive***  
one-piece fittings



**ParLock two-piece skive fittings**

# Full Flange System

Provides full flange mounting option for Code 61 and 62 ports.  
System flexibility reduces inventory investment.

## The full flange system addresses the needs of customers by:

- Being easier to assemble
- Providing one-piece integrity
- Being easier to handle
- Being easier to route in tight spaces
- Enabling assemblies to be sent to customers with the flange in place
- Easing bent tube installation (displacement angle) with a freely rotating flange



## The full flange system can be used repeatedly because of its patent-pending attachment system – the flange is not permanently locked onto the fitting.

- This is not a captive flange – it can easily be removed
- Flange can be reused if necessary
- Flange is not scrapped on a mis-crimp

## New Fitting Configuration

This newly introduced fitting configuration is specifically designed for Parker's full flange system, and will accept either a Code 61 or Code 62 flange. The X5, X7 and X9 fittings are designed to work with all Parkrimp crimpers. These new fittings can replace multiple existing fittings and help to reduce inventory.

## Reduction of Inventory

Parker's full flange system requires less inventory than the existing split flange system.

By using the new X5, X7 and X9 fittings, distributors can streamline inventory and can still respond to customer needs. Before the introduction of the full flange system, distributors needed to stock both Code 61 and 62 fittings to be prepared.



**1X577-20-20**

Straight Code 61 or Code 62 fitting.  
Alternative to 15, 4A and 6A configurations.

**1X777-20-20**

45° Code 61 or Code 62 fitting.  
Alternative to 17, 4F and 6F configurations.

**1X977-20-20**

90° Code 61 or Code 62 fitting.  
Alternative to 19, 4N and 6N configurations.

**For more information about Full Flange System please refer to pages Df-9 – Df-10, Dk-19 – Dk-20 and Eb-2**





# Hoses and Fittings

High pressure	Hose	371LT	Da-1
		372	Da-2
		372RH	Da-3
		372TC	Da-4
		701	Da-5
		721TC	Da-6
		731	Da-7
		761	Da-8
		772LT	Da-9
		774	Da-10
		781	Da-11
		P35	Da-12
		782TC	Da-13
		787TC	Da-14
		791TC	Da-15
		792TC	Da-15
		797TC	Da-16
		F42	Da-17
		H29	Da-18
		H29RH	Da-19
		H29TC	Da-20
		H29ST	Da-21
		H31	Da-22
		H31TC	Da-23
		H31ST	Da-24
		R35	Da-25
		R35TC	Da-26
		R42	Da-27
		R42TC	Da-28
		R42ST	Da-29
R50TC	Da-30		

High pressure	Fittings	Series Chapter	Parkrimp No-Skive						ParLock			
			70 series	71 series	73 series	76 series	77 series	78 series	79 series	S6 series	VS series	V4/V6/VB series
			Db-	Dc-	Dd-	De-	Df-	Dg-	Dh-	Di-	Dj-	Dk-
		<b>DIN - Metric</b>	1-4	1-4	1-2		1-2	1-2	1-2		2-5	2-5
		<b>BSP</b>	5-7	5-6	3-4		3-6	3-4			6-7	6-8
		<b>SAE</b>	8-10	7-9	5-7		7-9	5-7	1		8-10	9-11
		<b>Flange</b>	11-13	10-13	8-12	1	10-14	8-12	3-4	2-3	11-13	12-24
		<b>ORFS</b>	14-16	14-15	13-15		15-16	13-15	5-6		14-15	25-27
		<b>JIS</b>	17									
		<b>French Standard</b>	18		16						16	28
		<b>Others</b>	19	16	17							
		<b>R35TC-40</b>										29

Parker Hannifin assumes no liability for typographical errors or other errors

## Parkrimp No-Skive

3-braids Standard	3-braids low temperature	3-braids high abrasion res.	3-braids railway
<b>372</b> Da-2  <b>No-Skive Compact</b> 3-wire braid compact hose with 4SP working pressures	<b>371LT</b> Da-1  <b>No-Skive Compact</b> 3-wire braid low-temperature compact hose with 4SP working pressures	<b>372TC</b> Da-4  <b>No-Skive Compact</b> 3-wire braid compact hose with 4SP working pressures	<b>372RH</b> Da-3  <b>No-Skive Compact</b> 3-wire braid with fire-retardant cover

## Standard

<b>701</b> Da-5  <b>No-Skive Multispiral</b> ISO 3862 Type 4SP – DIN EN 856 Type 4SP	<b>731</b> Da-7  <b>No-Skive Multispiral</b> ISO 3862 Type 4SH – DIN EN 856 Type 4SH	<b>781</b> Da-11  <b>No-Skive Multispiral</b> SAE 100R13 – ISO 3862 Type R13 – DIN EN 856 Type R13	<b>P35</b> Da-12  <b>No-Skive Multispiral</b> SAE 100R13 – ISO 3862 Type R13 – DIN EN 856 Type R13
--	--	---	--

## Phosphate Ester

<b>774</b> Da-10  <b>No-Skive Multispiral</b> For phosphate ester base fluids	<b>F42</b> Da-27  <b>No-Skive Multispiral</b> For phosphate ester base fluids
--	--

## Extreme pressure

<b>761</b> Da-8  <b>No-Skive Multispiral</b> Ultra high pressure
---

## High abrasion resistance – MSHA approved

<b>721TC</b> Da-6  <b>No-Skive Multispiral</b> SAE 100R12 – DIN EN 856 Type R12 – ISO 3862 Type R12	<b>782TC</b> Da-13  <b>No-Skive Multispiral</b> SAE 100R13 – ISO 3862 Type R13 – DIN EN 856 Type R13	<b>791TC / 792TC</b> Da-15  <b>No-Skive Multispiral</b> SAE 100R15 – ISO 3862 Type R15
---	--	---

## Low temperature

<b>772LT</b> Da-9  <b>No-Skive Multispiral</b> Low-temperature spiral hose for extremely cold conditions
--

## Compact spiral





<b>787TC</b> Da-14  <b>No-Skive Compact Spiral</b> ISO 18752-DC	<b>797TC</b> Da-16  <b>No-Skive Compact Spiral</b> ISO 18752-DC
--	---

## ParLock



### Standard

<p><b>H29</b> Da-18</p>  <p><b>ParLock Multispiral</b> Exceeds ISO 3862 Type 4SH – DIN EN 856 Type 4SH</p>	<p><b>H31</b> Da-22</p>  <p><b>ParLock Multispiral</b> Exceeds ISO 3862 Type 4SP – DIN EN 856 Type 4SP</p>	<p><b>R35</b> Da-25</p>  <p><b>ParLock Multispiral</b> Exceeds ISO 3862 Type R13 – Parker Specifications</p>	<p><b>R42</b> Da-27</p>  <p><b>ParLock Multispiral</b> Exceeds ISO 3862 Type R15 – Parker Specifications</p>
---	---	--	---

### High abrasion resistance – MSHA approved

<p><b>H29TC</b> Da-20</p>  <p><b>ParLock Multispiral</b> Exceeds ISO 3862 Type 4SH – DIN EN 856 Type 4SH</p>	<p><b>H31TC</b> Da-23</p>  <p><b>ParLock Multispiral</b> Exceeds ISO 3862 Type 4SP – DIN EN 856 Type 4SP</p>	<p><b>R35TC</b> Da-26</p>  <p><b>ParLock Multispiral</b> Exceeds ISO 3862 Type R13 – Parker Specifications</p>	<p><b>R42TC</b> Da-28</p>  <p><b>ParLock Multispiral</b> Exceeds ISO 3862 Type R15 – Parker Specifications</p>
<p><b>R50TC</b> Da-30</p>  <p><b>ParLock Multispiral</b> Exceeds ISO 3862 Type R15 – Parker Specifications</p>			

### Extreme abrasion resistance

<p><b>H29ST</b> Da-21</p>  <p><b>ParLock Multispiral</b> Exceeds ISO 3862 Type 4SH – DIN EN 856 Type 4SH</p>	<p><b>H31ST</b> Da-24</p>  <p><b>ParLock Multispiral</b> Exceeds ISO 3862 Type 4SP – DIN EN 856 Type 4SP</p>	<p><b>R42ST</b> Da-29</p>  <p><b>ParLock Multispiral</b> Exceeds ISO 3862 Type R15 – Parker Specifications</p>
---	---	--

### Railway

<p><b>H29RH</b> Da-19</p>  <p><b>ParLock Multispiral</b> Fire-retardant cover – exceeds ISO 3862 Type 4SH – DIN EN 856 Type 4SH</p>
--





# 371LT

## No-Skive Compact

3-wire braid low-temperature compact hose with 4SP working pressures

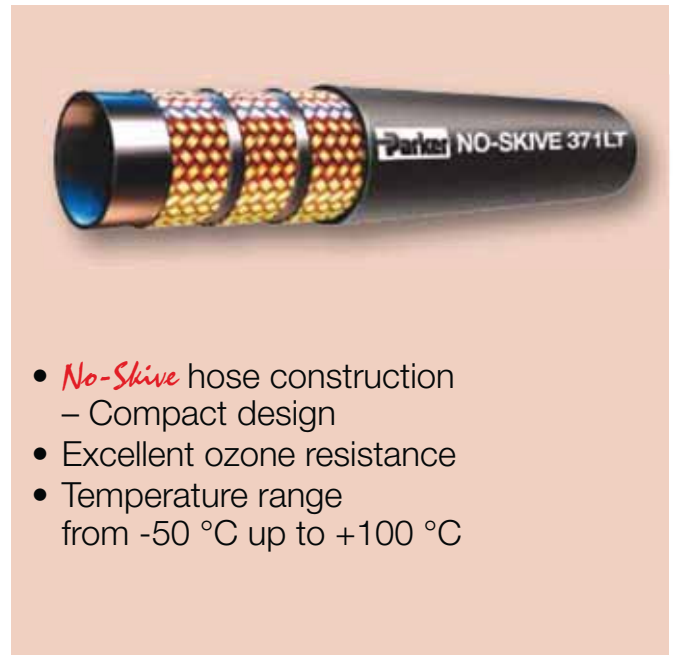

- *No-Skive* hose construction – Compact design
- Excellent ozone resistance
- Temperature range from -50 °C up to +100 °C

### Primary Applications

Mobile applications in low temperature environments:  
Forestry machines, refrigerated warehouses

### Applicable Specifications

Parker Specifications

### Construction

Tube: Synthetic rubber  
Reinforcement: Three high-tensile steel wire braids  
Cover: Synthetic rubber

Temperature Range ..... -50 °C up to +100 °C

Exception: Air ..... max. +70 °C  
Water ..... max. +85 °C

### Recommended Fluids

Petroleum and water-glycol based fluids, lubricating oils, air and water. For air above 1.7 MPa, the hose cover must be pin-pricked.

Consult the chemical compatibility section on pages **Ab-22** to **Ab-30** for more detailed information.

### Fitting Series



Part Number	Hose I.D.				Hose O.D. mm	Pressure Rating				min. bend radius mm	weight kg
	DN	Inch	Size	mm		max. working pressure		min. burst pressure			
						MPa	psi	MPa	psi		
371LT-6	10	3/8	-6	9.5	21.4	44.5	6500	178.0	26000	120	0.73
371LT-8	12	1/2	-8	12.7	24.6	41.5	6000	166.0	24000	160	0.90
371LT-10	16	5/8	-10	15.9	28.2	35.0	5000	140.0	20000	210	1.09
371LT-12	20	3/4	-12	19.1	32.2	35.0	5000	140.0	20000	260	1.36
371LT-16	25	1	-16	25.4	39.7	28.0	4000	112.0	16000	310	1.78

The combination of high temperature and high pressure could reduce the hose life.

# 372

## No-Skive Compact

3-wire braid compact hose with  
4SP working pressures

### Primary Applications

General high pressure small bending radii hydraulic applications

### Type Approvals

Details please find on pages **Ab-14** and **Ab-15**

### Applicable Specifications

Parker Specifications

### Construction

Tube: Nitrile (NBR)  
Reinforcement: Three high-tensile steel wire braids  
Cover: Synthetic rubber

Temperature Range ..... -40 °C up to +100 °C

Exception: Air ..... max. +70 °C  
Water ..... max. +85 °C



- *No-Skive* hose construction – Compact design
- Nitrile (NBR) inner tube for extended fluid compatibility

### Recommended Fluids

Petroleum and water-glycol based fluids, lubricating oils, air and water. For air above 1.7 MPa, the hose cover must be pin-pricked.

Consult the chemical compatibility section on pages **Ab-22** to **Ab-30** for more detailed information.

### Fitting Series



Part Number	Hose I.D.				Hose O.D. mm	Pressure Rating				min. bend radius mm	weight kg
	DN	Inch	Size	mm		max. working pressure		min. burst pressure			
						MPa	psi	MPa	psi		
372-6	10	3/8	-6	9.5	21.4	44.5	6500	180.0	25800	120	0.73
372-8	12	1/2	-8	12.7	24.6	41.5	6000	166.0	24000	160	0.90
372-10	16	5/8	-10	15.9	28.2	35.0	5000	140.0	20000	210	1.09
372-12	20	3/4	-12	19.1	32.2	35.0	5000	140.0	20000	260	1.36
372-16	25	1	-16	25.4	39.7	28.0	4000	112.0	16000	310	1.78

The combination of high temperature and high pressure could reduce the hose life.

# 372RH

## No-Skive Compact

3-wire braid with fire-retardant cover



- *No-Skive* hose construction
- Nitrile (NBR) inner tube – high chemical resistance
- Small bend radii
- Fire-retardant cover
- German Standard: **DIN 5510-2**
- French Standard: **NF F16-101/102 I2/F3**
- British Standard: **BS 6853 - Table 4**

### Primary Applications

Dynamic and static high-pressure hydraulic systems

### Type Approvals

Details please find on pages **Ab-14** and **Ab-15**

### Applicable Specifications

Parker specifications

Working pressure and O.D. to DIN EN 856-4SP

### Construction

Tube: Nitrile (NBR)

Reinforcement: Three high-tensile steel wire braids

Cover: Fire retardant synthetic rubber

Temperature Range ..... -40 °C up to +100 °C

Exception: Air ..... max. +70 °C

Water ..... max. +85 °C

### Recommended Fluids

Petroleum and water-glycol based fluids, lubricating oils, air and water. For air above 1.7 MPa, the hose cover must be pin-pricked.

Consult the chemical compatibility section on pages **Ab-22** to **Ab-30** for more detailed information.

### Fitting Series



Part Number	Hose I.D.				Hose O.D. mm	Pressure Rating				min. bend radius mm	weight kg
	DN	Inch	Size	mm		max. working pressure		min. burst pressure			
						MPa	psi	MPa	psi		
372RH-6	10	3/8	-6	9.5	21.4	44.5	6500	180.0	25800	120	0.73
372RH-8	12	1/2	-8	12.7	24.6	41.5	6000	166.0	24000	160	0.90
372RH-10	16	5/8	-10	15.9	28.2	35.0	5000	140.0	20000	210	1.09
372RH-12	20	3/4	-12	19.1	32.2	35.0	5000	140.0	20000	260	1.36
372RH-16	25	1	-16	25.4	39.7	28.0	4000	112.0	16000	310	1.78

The combination of high temperature and high pressure could reduce the hose life.

# 372TC

## No-Skive Compact

3-wire braid compact hose with 4SP working pressures

### Primary Applications

General high pressure hydraulic applications (typically in the mobile industry)

### Type Approvals

Details please find on pages **Ab-14** and **Ab-15**

### Applicable Specifications

Parker specifications – working pressures and outside diameters according to DIN EN 856-4SP

### Construction

Tube: Nitrile (NBR)  
Reinforcement: Three high-tensile steel wire braids  
Cover: Highly abrasion resistant  
MSHA approved synthetic rubber

Temperature Range ..... -40 °C up to +100 °C

Exception: Air ..... max. +70 °C  
Water ..... max. +85 °C

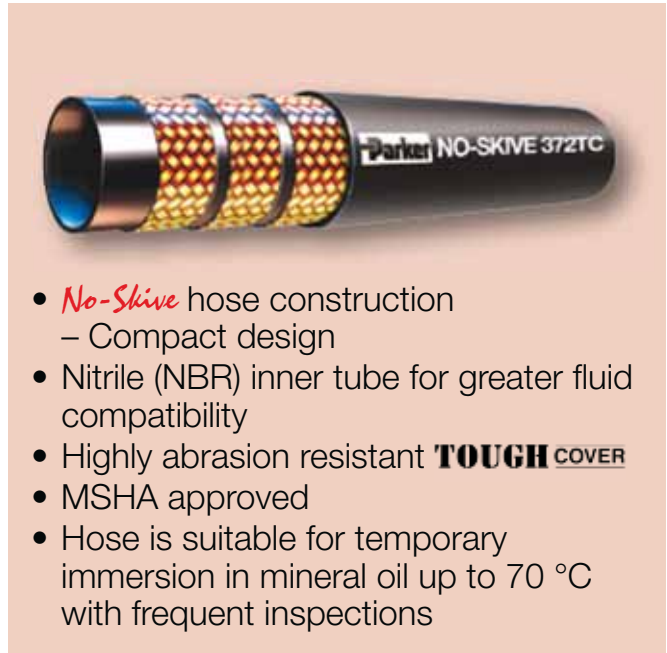

- *No-Skive* hose construction – Compact design
- Nitrile (NBR) inner tube for greater fluid compatibility
- Highly abrasion resistant **TOUGH COVER**
- MSHA approved
- Hose is suitable for temporary immersion in mineral oil up to 70 °C with frequent inspections

### Recommended Fluids

Petroleum and water-glycol based fluids, lubricating oils, air and water. For air above 1.7 MPa, the hose cover must be pin-pricked. The **TOUGH COVER** hose is suitable for immersion in mineral oils up to 70 °C.

Consult the chemical compatibility section on pages **Ab-22** to **Ab-30** for more detailed information.

### Fitting Series



Part Number	Hose I.D.				Hose O.D. mm	Pressure Rating				min. bend radius mm	weight kg
	DN	Inch	Size	mm		max. working pressure		min. burst pressure			
						MPa	psi	MPa	psi		
372TC-6	10	3/8	-6	9.5	21.4	44.5	6500	180.0	25800	120	0.73
372TC-8	12	1/2	-8	12.7	24.6	41.5	6000	166.0	24000	160	0.90
372TC-10	16	5/8	-10	15.9	28.2	35.0	5000	140.0	20000	210	1.09
372TC-12	20	3/4	-12	19.1	32.2	35.0	5000	140.0	20000	260	1.36
372TC-16	25	1	-16	25.4	39.7	28.0	4000	112.0	16000	310	1.78

Replace the hose when any deformation or damage on the hose cover are visible.  
The combination of high temperature and high pressure could reduce the hose life.

# 701

## No-Skive Multispiral

ISO 3862 Type 4SP – DIN EN 856 Type 4SP

### Primary Applications

General high pressure hydraulic applications

### Type Approvals

Details please find on pages **Ab-14** and **Ab-15**

### Applicable Specifications

ISO 3862 Type 4SP – DIN EN 856 Type 4SP

### Construction

Tube: Synthetic rubber  
Reinforcement: Four spirals high-tensile steel wire  
Cover: Synthetic rubber

Temperature Range ..... -40 °C up to +100 °C

Exception: Air ..... max. +70 °C  
Water ..... max. +85 °C



- *No-Skive* hose construction
- Reinforcement of four high tensile steel wires

### Recommended Fluids

Petroleum and water-glycol based fluids, lubricating oils, air and water. For air above 1.7 MPa, the hose cover must be pin-pricked.

Consult the chemical compatibility section on pages **Ab-22** to **Ab-30** for more detailed information.

### Fitting Series



Part Number	Hose I.D.				Hose O.D. mm	Pressure Rating				min. bend radius mm	weight kg
	DN	Inch	Size	mm		max. working pressure		min. burst pressure			
						MPa	psi	MPa	psi		
701-6	10	3/8	-6	9.5	21.4	45.0	6500	180.0	26000	180	0.78
701-8	12	1/2	-8	12.7	24.6	41.5	6000	166.0	24000	230	0.93
701-10	16	5/8	-10	15.9	28.2	35.0	5000	140.0	20000	250	1.15
701-12	20	3/4	-12	19.1	32.2	35.0	5000	140.0	20000	300	1.58
701-16	25	1	-16	25.4	39.7	28.0	4000	112.0	16000	340	2.04

The combination of high temperature and high pressure could reduce the hose life.

# 721TC

## No-Skive Multispiral

SAE 100R12 – DIN EN 856 Type R12 –  
ISO 3862 Type R12

### Primary Applications

High-pressure extremely small bending radii applications

### Type Approvals

Details please find on pages **Ab-14** and **Ab-15**

### Applicable Specifications

SAE 100R12 – DIN EN 856 Type R12 –  
ISO 3862 Type R12

### Construction

Tube: Synthetic rubber  
Reinforcement: Four spirals high-tensile steel wire  
Cover: High abrasion resistance  
MSHA approved synthetic rubber

Temperature Range ..... -40 °C up to +125 °C

Exception: Air ..... max. +70 °C  
Water ..... max. +85 °C

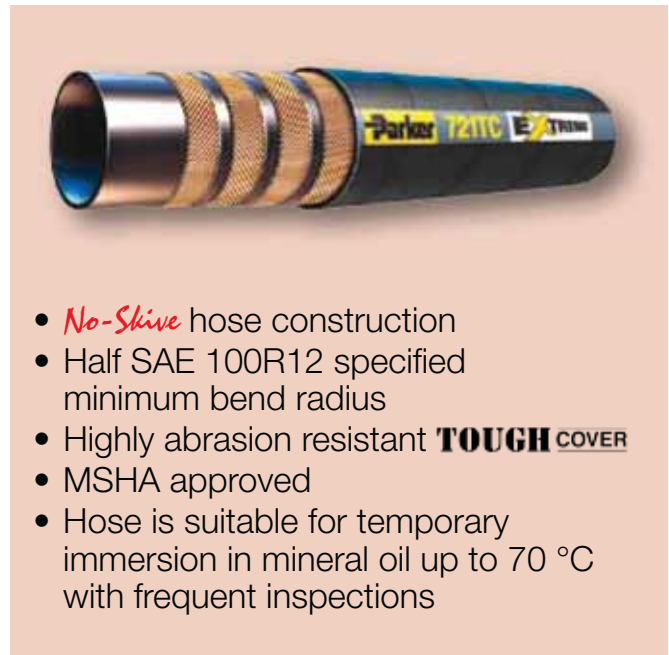

- *No-Skive* hose construction
- Half SAE 100R12 specified minimum bend radius
- Highly abrasion resistant **TOUGH COVER**
- MSHA approved
- Hose is suitable for temporary immersion in mineral oil up to 70 °C with frequent inspections

### Recommended Fluids

Petroleum and water-glycol based fluids, lubricating oils, air and water. For air above 1.7 MPa, the hose cover must be pin-pricked.

Consult the chemical compatibility section on pages **Ab-22** to **Ab-30** for more detailed information.

### Fitting Series



Part Number	Hose I.D.				Hose O.D. mm	Pressure Rating				min. bend radius mm	weight kg
	DN	Inch	Size	mm		max. working pressure		min. burst pressure			
						MPa	psi	MPa	psi		
721TC-6	10	3/8	-6	9.5	20.0	28.0	4000	112.0	16000	65	0.59
721TC-8	12	1/2	-8	12.7	24.0	28.0	4000	112.0	16000	90	0.80
721TC-10	16	5/8	-10	15.9	27.0	28.0	4000	112.0	16000	100	1.10
721TC-12	20	3/4	-12	19.1	31.0	28.0	4000	112.0	16000	120	1.40
721TC-16	25	1	-16	25.4	38.0	28.0	4000	112.0	16000	150	1.99
721TC-20	32	1-1/4	-20	31.8	47.0	21.0	3000	84.0	12000	210	2.59
721TC-24	40	1-1/2	-24	38.1	53.0	17.5	2500	70.0	10000	250	2.99
721TC-32	50	2	-32	50.8	67.0	17.5	2500	70.0	10000	320	4.09

Replace the hose when any deformation or damage on the hose cover are visible.  
The combination of high temperature and high pressure could reduce the hose life.

# 731

## No-Skive Multispiral

ISO 3862 Type 4SH – DIN EN 856 Type 4SH



- *No-Skive* hose construction
- Reinforcement of four high tensile steel wires

### Primary Applications

General high pressure hydraulic applications

### Applicable Specifications

ISO 3862 Type 4SH – DIN EN 856 Type 4SH

### Construction

Tube: Synthetic rubber  
 Reinforcement: Four spirals high-tensile steel wire  
 Cover: Synthetic rubber

Temperature Range ..... -40 °C up to +100 °C

Exception: Air ..... max. +70 °C  
 Water ..... max. +85 °C

### Recommended Fluids

Petroleum and water-glycol based fluids, lubricating oils, air and water. For air above 1.7 MPa, the hose cover must be pin-pricked.

Consult the chemical compatibility section on pages **Ab-22** to **Ab-30** for more detailed information.

### Fitting Series



Part Number	Hose I.D.				Hose O.D. mm	Pressure Rating				min. bend radius mm	weight kg
	DN	Inch	Size	mm		max. working pressure		min. burst pressure			
						MPa	psi	MPa	psi		
731-12	20	3/4	-12	19.1	32.0	42.0	6000	168.0	24000	280	1.72
731-16	25	1	-16	25.4	39.0	38.0	5500	152.0	22000	340	2.14
731-20	32	1-1/4	-20	31.8	45.0	32.0	4700	130.0	18800	460	2.96
731-24	40	1-1/2	-24	38.1	53.0	29.0	4200	116.0	16800	560	3.20
731-32	50	2	-32	50.8	68.0	25.0	3600	100.0	14400	700	5.30

Tough Cover (MSHA approved) can be ordered with the extension „TC“ e. g. 731TC-..  
 The combination of high temperature and high pressure could reduce the hose life.

# 761

## No-Skive Multispiral

Ultra high pressure



- Creates new design possibilities for high pressure applications
- *No-Skive* design eliminates the need to remove the cover before crimping
- Durable, colour layline for easy and longer lasting identification
- Flexibility is comparable to SAE 100R15
- Constant working pressure of 56.0 MPa

### Primary Applications

High performance/high pressure applications such as construction, hydrostatic drive lines, agriculture, mining, test stands

### Construction

Tube: Synthetic rubber  
Reinforcement: Six spirals high-tensile steel wire  
Cover: Abrasion resistant black synthetic rubber

### Recommended Fluids

Petroleum-based hydraulic fluids and lubricating oils. Consult the chemical compatibility section on pages **Ab-22** to **Ab-30** for more detailed information.

Temperature Range ..... -40 °C up to +125 °C

### Fitting Series



Part Number	Hose I.D.				Hose O.D. mm	Pressure Rating				min. bend radius mm	weight kg
	DN	Inch	Size	mm		max. working pressure		min. burst pressure			
						MPa	psi	MPa	psi		
761-12	20	3/4	-12	19.1	34.8	56.0	8000	224.0	32000	260	2.32
761-16	25	1	-16	25.4	41.9	56.0	8000	224.0	32000	330	3.00

The combination of high temperature and high pressure could reduce the hose life.



# 772LT

## No-Skive Multispiral

Low-temperature spiral hose for extremely cold conditions

### Primary Applications

Snow grooming equipment, heavy construction equipment, sidebooms

### Applicable Specifications

Exceeds SAE 100R12 – ISO 3862 Type R12 – DIN EN 856 Type R12

### Construction

Tube: Nitrile (NBR)  
Reinforcement: Four spirals high-tensile steel wire  
Cover: Synthetic rubber

Temperature Range ..... -57 °C up to +100 °C

Exception: Air ..... max. +70 °C  
Water ..... max. +85 °C



- *No-Skive* hose construction
- Exceeds SAE 100R12 / ISO 3862-1 Type R12 / DIN EN 856 Type R12
- Temperature range from -57 °C to 100 °C

### Recommended Fluids

Petroleum and water-glycol based fluids, lubricating oils, air and water. For air above 1.7 MPa, the hose cover must be pin-pricked.

Consult the chemical compatibility section on pages **Ab-22** to **Ab-30** for more detailed information.

### Fitting Series



Part Number	Hose I.D.				Hose O.D. mm	Pressure Rating				min. bend radius mm	weight kg
	DN	Inch	Size	mm		max. working pressure		min. burst pressure			
						MPa	psi	MPa	psi		
772LT-8	12	1/2	-8	12.7	24.0	28.0	4000	112.0	16000	180	0.93
772LT-10	16	5/8	-10	15.9	27.0	28.0	4000	112.0	16000	200	1.10
772LT-12	20	3/4	-12	19.1	31.0	28.0	4000	112.0	16000	240	1.40
772LT-16	25	1	-16	25.4	38.0	28.0	4000	112.0	16000	300	1.99
772LT-20	32	1-1/4	-20	31.8	46.0	21.0	3000	84.0	12000	420	2.59
772LT-24	40	1-1/2	-24	38.1	53.0	17.5	2500	70.0	10000	500	2.99

The combination of high temperature and high pressure could reduce the hose life.

# 774

## No-Skive Multispiral

For phosphate ester base fluids

### Primary Applications

Test stands for aerospace, foundries, steel mills  
High pressure hydraulic applications with phosphate ester fluids

### Restrictions

Do not allow tube to contact any petroleum base fluids.  
Use liquid soap as hose lubricant.

### Applicable Specifications

Parker specifications

### Construction

Tube: Phosphate ester resistant EPDM synthetic rubber  
Reinforcement: Four spirals high-tensile steel wire  
Cover: Phosphate ester and weather resistant, green, EPDM synthetic rubber cover

Temperature Range ..... -40 °C up to +80 °C



- *No-Skive* hose construction
- Phosphate ester and weather resistant, green, EPDM synthetic rubber cover

### Recommended Fluids

Phosphate ester base hydraulic fluids.  
Consult the chemical compatibility section on pages **Ab-22** to **Ab-30** for more detailed information.

### Fitting Series



Part Number	Hose I.D.				Hose O.D. mm	Pressure Rating				min. bend radius mm	weight kg
	DN	Inch	Size	mm		max. working pressure		min. burst pressure			
						MPa	psi	MPa	psi		
774-12	20	3/4	-12	19.1	31.0	28.0	4000	112.0	16000	240	1.40
774-16	25	1	-16	25.4	38.0	28.0	4000	112.0	16000	300	1.99
774-20	32	1-1/4	-20	31.8	47.0	21.0	3000	84.0	12000	420	2.59
774-24	40	1-1/2	-24	38.1	53.0	17.5	2500	70.0	10000	500	2.99
774-32	50	2	-32	50.8	67.0	17.5	2500	70.0	10000	630	4.09

The combination of high temperature and high pressure could reduce the hose life.

# 781

## No-Skive Multispiral

SAE 100R13 – ISO 3862 Type R13 –  
DIN EN 856 Type R13

### Primary Applications

General extremely high pressure hydraulic applications

### Applicable Specifications

SAE 100R13 – ISO 3862 Type R13 –  
DIN EN 856 Type R13

### Construction

Tube: Synthetic rubber  
Reinforcement: Four or six spirals high-tensile steel wire  
Cover: Synthetic rubber

Temperature Range ..... -40 °C up to +125 °C

Exception: Air ..... max. +70 °C  
Water ..... max. +85 °C



- *No-Skive* hose construction
- Reinforcement of four or six high tensile steel wires
- Constant working pressure of 35.0 Mpa

### Recommended Fluids

Petroleum and water-glycol based fluids, lubricating oils, air and water. For air above 1.7 MPa, the hose cover must be pin-pricked.

Consult the chemical compatibility section on pages **Ab-22** to **Ab-30** for more detailed information.

### Fitting Series



Part Number	Hose I.D.				Hose O.D. mm	Pressure Rating				min. bend radius mm	weight kg
	DN	Inch	Size	mm		max. working pressure		min. burst pressure			
						MPa	psi	MPa	psi		
781-12	20	3/4	-12	19.1	32.0	35.0	5000	140.0	20000	240	1.59
781-16	25	1	-16	25.4	39.0	35.0	5000	140.0	20000	300	2.20
781-20	32	1-1/4	-20	31.8	50.0	35.0	5000	140.0	20000	420	3.69
781-24	40	1-1/2	-24	38.1	57.0	35.0	5000	140.0	20000	500	4.79

The combination of high temperature and high pressure could reduce the hose life.

## P35

### No-Skive Multispiral

SAE 100R13 – ISO 3862 Type R13 –  
DIN EN 856 Type R13

#### Primary Applications

Mobile/ industrial hydraulics:

Generally extremely high pressure large flow hydraulic applications

#### Type Approvals

Details please find on pages **Ab-14** and **Ab-15**

#### Applicable Specifications

SAE 100R13 – ISO 3862 Type R13 –  
DIN EN 856 Type R13

#### Construction

Tube: Synthetic rubber  
Reinforcement: Six spirals high-tensile steel wire  
Cover: Synthetic rubber

Temperature Range ..... -40 °C up to +125 °C

Exception: Air ..... max. +70 °C  
Water ..... max. +85 °C



- *No-Skive* hose construction
- Reinforcement of six high tensile steel wires

#### Recommended Fluids

Petroleum and water-glycol based fluids, lubricating oils, air and water. For air above 1.7 MPa, the hose cover must be pin-pricked.

Consult the chemical compatibility section on pages **Ab-22** to **Ab-30** for more detailed information.

#### Fitting Series



Part Number	Hose I.D.				Hose O.D. mm	Pressure Rating				min. bend radius mm	weight kg
	DN	Inch	Size	mm		max. working pressure		min. burst pressure			
						MPa	psi	MPa	psi		
P35-32	50	2	-32	50.8	71.0	35.0	5000	140.0	20000	630	7.48

The combination of high temperature and high pressure could reduce the hose life.

# 782TC

## No-Skive Multispiral

SAE 100R13 – ISO 3862 Type R13 –  
DIN EN 856 Type R13

### Primary Applications

Generally extremely high pressure hydraulic applications

### Type Approvals

Details please find on pages **Ab-14** and **Ab-15**

### Applicable Specifications

SAE 100R13 – ISO 3862 Type R13 –  
DIN EN 856 Type R13

### Construction

Tube: Nitrile (NBR)  
Reinforcement: Four spirals high-tensile steel wire  
Cover: High abrasion resistance  
MSHA approved synthetic rubber

Temperature Range ..... -40 °C up to +125 °C

Exception: Air ..... max. +70 °C  
Water ..... max. +85 °C

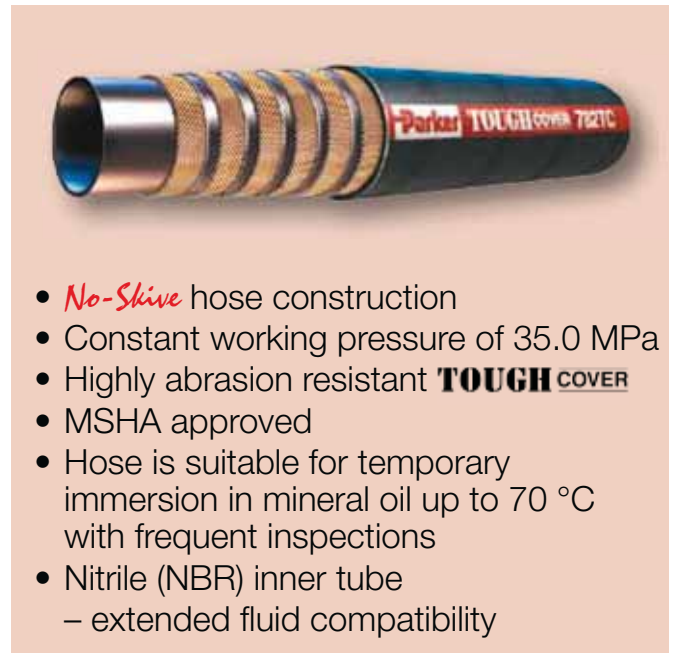

- *No-Skive* hose construction
- Constant working pressure of 35.0 MPa
- Highly abrasion resistant **TOUGH COVER**
- MSHA approved
- Hose is suitable for temporary immersion in mineral oil up to 70 °C with frequent inspections
- Nitrile (NBR) inner tube  
– extended fluid compatibility

### Recommended Fluids

Petroleum and water-glycol based fluids, lubricating oils, air and water. For air above 1.7 MPa, the hose cover must be pin-pricked.

Consult the chemical compatibility section on pages **Ab-22** to **Ab-30** for more detailed information.

### Fitting Series



Part Number	Hose I.D.				Hose O.D. mm	Pressure Rating				min. bend radius mm	weight kg
	DN	Inch	Size	mm		max. working pressure		min. burst pressure			
						MPa	psi	MPa	psi		
782TC-12	20	3/4	-12	19.1	32.0	35.0	5000	140.0	20000	240	1.59
782TC-16	25	1	-16	25.4	39.0	35.0	5000	140.0	20000	300	2.20
782TC-20	32	1-1/4	-20	31.8	50.0	35.0	5000	140.0	20000	420	3.69
782TC-24	40	1-1/2	-24	38.1	57.0	35.0	5000	140.0	20000	500	4.79

Replace the hose when any deformation or damage on the hose cover are visible.  
The combination of high temperature and high pressure could reduce the hose life.

# 787TC

*No-Skive* Compact Spiral  
ISO 18752-DC



- 1/2 the bend radius of SAE 100R13
- Constant working pressure of 35.0 MPa
- Reduced O.D. and new construction lead to superior flexibility
- 1/3 less effort to bend
- Weight reduction – up to 26 %
- Highly abrasion resistant **TOUGH COVER**
- MSHA approved
- Hose is suitable for temporary immersion in mineral oil up to 70 °C with frequent inspections

## Primary Applications

On- & offshore, construction, injection moulding, mining

## Applicable Specifications

SAE 100R13 – ISO 3862 Type R13 – ISO 18752-DC

## Construction

Tube: Proprietary synthetic rubber  
Reinforcement: Four spirals high-tensile steel wire  
Cover: High abrasion resistance  
MSHA approved synthetic rubber

## Recommended Fluids

Petroleum based hydraulic fluids and lubricating oils.  
Wide Compatibility exceeding Column III, with additional chemical resistance, especially for diesel and biodiesel.  
For chemical compatibility please contact  
HPDE\_helpdesk@parker.com

Temperature Range ..... -40 °C up to +125 °C

Exception: Air ..... max. +70 °C

Water ..... max. +85 °C

## Fitting Series



Part Number	Hose I.D.				Hose O.D. mm	Pressure Rating				min. bend radius mm	weight kg
	DN	Inch	Size	mm		max. working pressure		min. burst pressure			
						MPa	psi	MPa	psi		
787TC-8	12	1/2	-8	12.7	21.1	35.0	5000	140.0	20000	90	0.67
787TC-10	16	5/8	-10	15.9	23.9	35.0	5000	140.0	20000	100	0.80
787TC-12	20	3/4	-12	19.1	27.9	35.0	5000	140.0	20000	120	1.16
787TC-16	25	1	-16	25.4	35.7	35.0	5000	140.0	20000	150	1.74
787TC-20	32	1-1/4	-20	31.5	44.9	35.0	5000	140.0	20000	210	2.89

Replace the hose when any deformation or damage on the hose cover are visible.  
The combination of high temperature and high pressure could reduce the hose life.

# 791TC / 792TC

## No-Skive Multispiral

SAE 100R15 – ISO 3862 Type R15

### Primary Applications

Mobile hydraulics: Hydrostatic drives  
General industrial hydraulics: Injection moulding machines  
Test stands

### Type Approvals

Details please find on pages **Ab-14** and **Ab-15**

### Applicable Specifications

SAE 100R15 – ISO 3862 Type R15

### Construction

Tube 791TC: Synthetic rubber  
Tube 792TC: Nitrile (NBR)  
Reinforcement: Four or six spirals high-tensile steel wire  
Cover: High abrasion resistance  
MSHA approved synthetic rubber

Temperature Range ..... -40 °C up to +100 °C

Exception: Air ..... max. +70 °C

Water ..... max. +85 °C

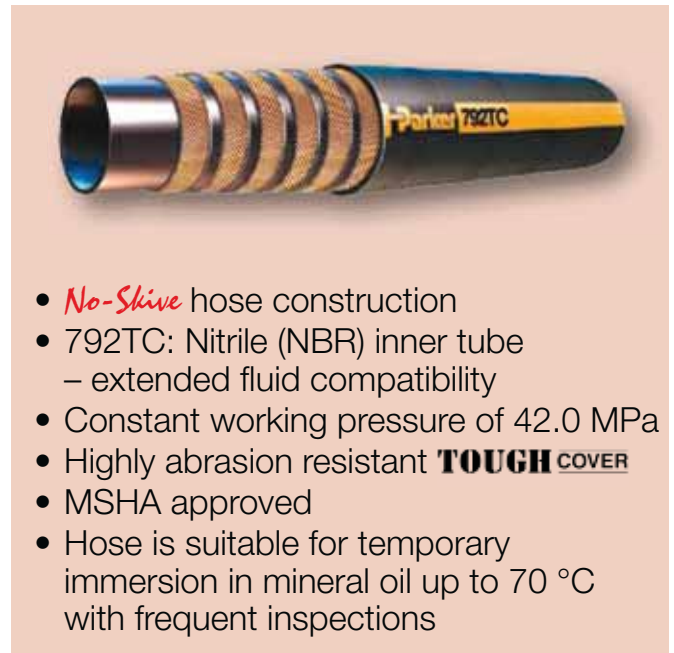

- *No-Skive* hose construction
- 792TC: Nitrile (NBR) inner tube – extended fluid compatibility
- Constant working pressure of 42.0 MPa
- Highly abrasion resistant **TOUGH COVER**
- MSHA approved
- Hose is suitable for temporary immersion in mineral oil up to 70 °C with frequent inspections

### Recommended Fluids

Petroleum and water-glycol based fluids, lubricating oils, air and water. For air above 1.7 MPa, the hose cover must be pin-pricked.

Consult the chemical compatibility section on pages **Ab-22** to **Ab-30** for more detailed information.

### Fitting Series



Part Number	Hose I.D.				Hose O.D. mm	Pressure Rating				min. bend radius mm	weight kg
	DN	Inch	Size	mm		max. working pressure		min. burst pressure			
						MPa	psi	MPa	psi		
792TC-12	20	3/4	-12	19.1	32.0	42.0	6000	168.0	24000	265	1.59
792TC-16	25	1	-16	25.4	39.0	42.0	6000	168.0	24000	330	2.20
791TC-20	32	1-1/4	-20	31.8	50.0	42.0	6000	168.0	24000	250	3.69
791TC-24	40	1-1/2	-24	38.1	57.0	42.0	6000	168.0	24000	305	4.79

Replace the hose when any deformation or damage on the hose cover are visible.  
The combination of high temperature and high pressure could reduce the hose life.

# 797TC

*No-Skive* Compact Spiral  
ISO 18752-DC



- 1/2 the bend radius of SAE 100R15
- Constant working pressure of 42.0 MPa
- Reduced O.D. and new construction lead to superior flexibility
- 1/3 less effort to bend
- Weight reduction – up to 26 %
- Highly abrasion resistant **TOUGH COVER**
- MSHA approved
- Hose is suitable for temporary immersion in mineral oil up to 70 °C with frequent inspections

## Primary Applications

On- & offshore, construction, injection moulding, mining

## Applicable Specifications

SAE 100R15 – ISO 3862 Type R15 – ISO 18752-DC

## Construction

Tube: Proprietary synthetic rubber  
Reinforcement: Four spirals high-tensile steel wire  
Cover: High abrasion resistance  
MSHA approved synthetic rubber

## Recommended Fluids

Petroleum base hydraulic fluids and lubricating oils.  
Wide Compatibility exceeding Column III, with additional chemical resistance, especially for diesel and biodiesel.  
For chemical compatibility please contact  
HPDE\_helpdesk@parker.com

Temperature Range ..... -40 °C up to +125 °C

Exception: Air ..... max. +70 °C

Water ..... max. +85 °C

## Fitting Series



Part Number	Hose I.D.				Hose O.D. mm	Pressure Rating				min. bend radius mm	weight kg
	DN	Inch	Size	mm		max. working pressure		min. burst pressure			
						MPa	psi	MPa	psi		
797TC-8	12	1/2	-8	12.7	21.1	42.0	6000	168.0	24000	100	0.67
797TC-10	16	5/8	-10	15.9	23.9	42.0	6000	168.0	24000	115	0.80
797TC-12	20	3/4	-12	19.1	27.9	42.0	6000	168.0	24000	135	1.16
797TC-16	25	1	-16	25.4	35.7	42.0	6000	168.0	24000	165	1.74
797TC-20	32	1-1/4	-20	31.5	44.9	42.0	6000	168.0	24000	225	2.89

Replace the hose when any deformation or damage on the hose cover are visible.  
The combination of high temperature and high pressure could reduce the hose life.



# F42

## No-Skive Multispiral

For phosphate ester base fluids

### Primary Applications

Test stands for aerospace, foundries, steel mills  
High pressure hydraulic applications with phosphate ester fluids

### Applicable Specifications

Parker Specification

### Restrictions

Do not allow tube to contact any petroleum base fluids.  
Use liquid soap as hose lubricant.

### Construction

Tube: Phosphate ester resistant EPDM synthetic rubber  
Reinforcement: Four or six spirals high-tensile steel wire  
Cover: Phosphate ester and weather resistant, green EPDM synthetic rubber cover

Temperature Range ..... -40 °C up to +80 °C

Exception: Air ..... max. +70 °C

Water ..... max. +85 °C



- *No-Skive* hose construction
- Phosphate ester and weather resistant, green, EPDM synthetic rubber cover
- Constant working pressure of 42.0 MPa

### Recommended Fluids

Phosphate ester based hydraulic fluids, water-glycol based fluids, air and water.

Consult the chemical compatibility section on pages **Ab-22** to **Ab-30** for more detailed information.

### Fitting Series

\* series 70 only for size -8



Part Number	Hose I.D.				Hose O.D. mm	Pressure Rating				min. bend radius mm	weight kg
	DN	Inch	Size	mm		max. working pressure		min. burst pressure			
						MPa	psi	MPa	psi		
F42-8	12	1/2	-8	12.7	25.0	42.0	6000	168.0	24000	200	0.83
F42-12	20	3/4	-12	19.1	31.9	42.0	6000	168.0	24000	265	1.53
F42-16	25	1	-16	25.4	38.5	42.0	6000	168.0	24000	330	2.08
F42-20	32	1-1/4	-20	31.8	50	42.0	6000	168.0	24000	445	3.96

The combination of high temperature and high pressure could reduce the hose life.

# H29

## ParLock Multispiral

Exceeds ISO 3862 Type 4SH –  
DIN EN 856 Type 4SH

### Primary Applications

General high pressure hydraulic applications

### Type Approvals

Details please find on pages **Ab-14** and **Ab-15**

### Applicable Specifications

Exceeds ISO 3862 Type 4SH – DIN EN 856 Type 4SH

### Construction

Tube: Synthetic rubber  
Reinforcement: Four spirals high-tensile steel wire  
Cover: Synthetic rubber

Temperature Range ..... -40 °C up to +100 °C

Exception: Air ..... max. +70 °C  
Water ..... max. +85 °C



- Interlock technology
- Reinforcement of four high tensile steel wires

### Recommended Fluids

Petroleum and water-glycol based fluids, lubricating oils, air and water. For air above 1.7 MPa, the hose cover must be pin-pricked.

Consult the chemical compatibility section on pages **Ab-22** to **Ab-30** for more detailed information.

### Fitting Series

Internal and external skiving



Part Number	Hose I.D.				Hose O.D.	Pressure Rating				min. bend radius mm	weight kg
	DN	Inch	Size	mm	mm	max. working pressure		min. burst pressure			
						MPa	psi	MPa	psi		
H29-12	20	3/4	-12	19.1	32.2	43.0	6250	172.0	25000	280	1.7
H29-16	25	1	-16	25.4	38.7	40.0	5800	160.0	23200	340	2.2
H29-20	32	1-1/4	-20	31.8	45.5	35.0	5000	140.0	20000	460	2.6
H29-24	38	1-1/2	-24	38.1	53.5	31.0	4500	124.0	18000	560	3.4
H29-32	50	2	-32	50.8	68.1	28.0	4050	112.0	16200	700	4.8

The combination of high temperature and high pressure could reduce the hose life.

# H29RH

## ParLock Multispiral

Fire-retardant cover – exceeds  
ISO 3862 Type 4SH – DIN EN 856 Type 4SH

### Primary Applications

General high pressure hydraulic applications

### Type Approvals

Details please find on pages **Ab-14** and **Ab-15**

### Applicable Specifications

Exceeds ISO 3862 Type 4SH – DIN EN 856 Type 4SH

### Construction

Tube: Synthetic rubber  
Reinforcement: Four spirals high-tensile steel wire  
Cover: Fire retardant synthetic rubber

Temperature Range ..... -40 °C up to +100 °C

Exception: Air ..... max. +70 °C  
Water ..... max. +85 °C



- Interlock technology
- Reinforcement of four high tensile steel wires
- Fire-retardant cover
- German Standard: **DIN 5510-2**
- French Standard: **NF F16-101/102 I2/F3**
- British Standard: **BS 6853 - Table 4**

### Recommended Fluids

Petroleum and water-glycol based fluids, lubricating oils, air and water. For air above 1.7 MPa, the hose cover must be pin-pricked.

Consult the chemical compatibility section on pages **Ab-22** to **Ab-30** for more detailed information.

### Fitting Series

Internal and external skiving



Part Number	Hose I.D.				Hose O.D. mm	Pressure Rating				min. bend radius mm	weight kg
	DN	Inch	Size	mm		max. working pressure		min. burst pressure			
						MPa	psi	MPa	psi		
H29RH-16	25	1	-16	25.4	38.7	40.0	5800	160.0	23200	340	2.2
H29RH-20	32	1-1/4	-20	31.8	45.5	35.0	5000	140.0	20000	460	2.6
H29RH-24	38	1-1/2	-24	38.1	53.5	31.0	4500	124.0	18000	560	3.4

The combination of high temperature and high pressure could reduce the hose life.

## H29TC

### ParLock Multispiral

Exceeds ISO 3862 Type 4SH –  
DIN EN 856 Type 4SH

#### Primary Applications

General high pressure hydraulic applications

#### Type Approvals

Details please find on pages **Ab-14** and **Ab-15**

#### Applicable Specifications

Exceeds ISO 3862 Type 4SH – DIN EN 856 Type 4SH

#### Construction

Tube: Synthetic rubber  
Reinforcement: Four spirals high-tensile steel wire  
Cover: High abrasion resistance  
MSHA approved synthetic rubber

Temperature Range ..... -40 °C up to +100 °C

Exception: Air ..... max. +70 °C  
Water ..... max. +85 °C



- Interlock technology
- Reinforcement of four high tensile steel wires
- Highly abrasion resistant **TOUGH COVER**
- MSHA approved
- Hose is suitable for temporary immersion in mineral oil up to 70 °C with frequent inspections

#### Recommended Fluids

Petroleum and water-glycol based fluids, lubricating oils, air and water. For air above 1.7 MPa, the hose cover must be pin-pricked.

Consult the chemical compatibility section on pages **Ab-22** to **Ab-30** for more detailed information.

#### Fitting Series

Internal and external skiving



Part Number	Hose I.D.				Hose O.D. mm	Pressure Rating				min. bend radius mm	weight kg
	DN	Inch	Size	mm		max. working pressure		min. burst pressure			
						MPa	psi	MPa	psi		
H29TC-12	20	3/4	-12	19.1	32.2	43.0	6250	172.0	25000	280	1.7
H29TC-16	25	1	-16	25.4	38.7	40.0	5800	160.0	23200	340	2.2
H29TC-20	32	1-1/4	-20	31.8	45.5	35.0	5000	140.0	20000	460	2.6
H29TC-24	38	1-1/2	-24	38.1	53.5	31.0	4500	124.0	18000	560	3.4
H29TC-32	50	2	-32	50.8	68.1	28.0	4050	112.0	16200	700	4.8

Replace the hose when any deformation or damage on the hose cover are visible.  
The combination of high temperature and high pressure could reduce the hose life.

# H29ST

## ParLock Multispiral

Exceeds ISO 3862 Type 4SH –  
DIN EN 856 Type 4SH



- Interlock technology
- Extreme abrasion resistant  
**SUPER TOUGH** cover
- Reinforcement of four high tensile steel wires

### Primary Applications

General high pressure hydraulic applications

### Applicable Specifications

Exceeds ISO 3862 Type 4SH – DIN EN 856 Type 4SH

### Construction

Tube: Synthetic rubber  
Reinforcement: Four spirals high-tensile steel wire  
Cover: Synthetic rubber with special polyethylene coating

### Recommended Fluids

Petroleum and water-glycol based fluids, lubricating oils, air and water. For air above 1.7 MPa, the hose cover must be pin-pricked.  
Consult the chemical compatibility section on pages **Ab-22** to **Ab-30** for more detailed information.

Temperature Range ..... -40 °C up to +100 °C

Exception: Air ..... max. +70 °C  
Water ..... max. +85 °C

### Fitting Series

Internal and external skiving



Part Number	Hose I.D.				Hose O.D. mm	Pressure Rating				min. bend radius mm	weight kg
	DN	Inch	Size	mm		max. working pressure		min. burst pressure			
						MPa	psi	MPa	psi		
H29ST-12	20	3/4	-12	19.1	32.2	43.0	6250	172.0	25000	280	1.7
H29ST-16	25	1	-16	25.4	38.7	40.0	5800	160.0	23200	340	2.2
H29ST-20	32	1-1/4	-20	31.8	45.5	35.0	5000	140.0	20000	460	2.6
H29ST-24	38	1-1/2	-24	38.1	53.5	31.0	4500	124.0	18000	560	3.4
H29ST-32	50	2	-32	50.8	68.1	28.0	4050	112.0	16200	700	4.8

The combination of high temperature and high pressure could reduce the hose life.

# H31

## ParLock Multispiral

Exceeds ISO 3862 Type 4SP –  
DIN EN 856 Type 4SP

### Primary Applications

General high pressure hydraulic applications

### Type Approvals

Details please find on pages **Ab-14** and **Ab-15**

### Applicable Specifications

Exceeds ISO 3862 Type 4SP – DIN EN 856 Type 4SP

### Construction

Tube: Synthetic rubber  
Reinforcement: Four spirals high-tensile steel wire  
Cover: Synthetic rubber

Temperature Range ..... -40 °C up to +100 °C

Exception: Air ..... max. +70 °C  
Water ..... max. +85 °C



- Interlock technology
- Reinforcement of four high tensile steel wires

### Recommended Fluids

Petroleum and water-glycol based fluids, lubricating oils, air and water. For air above 1.7 MPa, the hose cover must be pin-pricked.

Consult the chemical compatibility section on pages **Ab-22** to **Ab-30** for more detailed information.

### Fitting Series

External skiving (size -4 up to -8)

Internal and external skiving (size -10 up to -16)



Part Number	Hose I.D.				Hose O.D. mm	Pressure Rating				min. bend radius mm	weight kg
	DN	Inch	Size	mm		max. working pressure		min. burst pressure			
						MPa	psi	MPa	psi		
H31-4	6	1/4	-4	6.3	17.8	50.0	7250	200.0	29000	120	0.73
H31-6	10	3/8	-6	9.5	21.4	44.5	6450	178.0	25800	130	0.91
H31-8	12	1/2	-8	12.7	24.6	41.5	6000	166.0	24000	180	1.08
H31-10	16	5/8	-10	15.9	28.5	39.0	5650	156.0	22600	225	1.39
H31-12	20	3/4	-12	19.1	32.0	35.0	5000	140.0	20300	280	1.73
H31-16	25	1	-16	25.4	39.7	31.0	4500	124.0	18000	355	2.31

The combination of high temperature and high pressure could reduce the hose life.

# H31TC

## ParLock Multispiral

Exceeds ISO 3862 Type 4SP –  
DIN EN 856 Type 4SP

### Primary Applications

General high pressure hydraulic applications

### Type Approvals

Details please find on pages **Ab-14** and **Ab-15**

### Applicable Specifications

Exceeds ISO 3862 Type 4SP – DIN EN 856 Type 4SP

### Construction

Tube: Synthetic rubber  
Reinforcement: Four spirals high-tensile steel wire  
Cover: High abrasion resistance  
MSHA approved synthetic rubber

Temperature Range ..... -40 °C up to +100 °C

Exception: Air ..... max. +70 °C  
Water ..... max. +85 °C



- Interlock technology
- Reinforcement of four high tensile steel wires
- Highly abrasion resistant **TOUGH COVER**
- MSHA approved
- Hose is suitable for temporary immersion in mineral oil up to 70 °C with frequent inspections

### Recommended Fluids

Petroleum and water-glycol based fluids, lubricating oils, air and water. For air above 1.7 MPa, the hose cover must be pin-pricked.

Consult the chemical compatibility section on pages **Ab-22** to **Ab-30** for more detailed information.

### Fitting Series

External skiving (size -4 up to -8)

Internal and external skiving (size -10 up to -16)



Part Number	Hose I.D.				Hose O.D. mm	Pressure Rating				min. bend radius mm	weight kg
	DN	Inch	Size	mm		max. working pressure		min. burst pressure			
						MPa	psi	MPa	psi		
H31TC-4	6	1/4	-4	6.3	17.8	50.0	7250	200.0	29000	120	0.73
H31TC-6	10	3/8	-6	9.5	21.4	44.5	6450	178.0	25800	130	0.91
H31TC-8	12	1/2	-8	12.7	24.6	41.5	6000	166.0	24000	180	1.08
H31TC-10	16	5/8	-10	15.9	28.5	39.0	5650	156.0	22600	225	1.39
H31TC-12	20	3/4	-12	19.1	32.0	35.0	5000	140.0	20300	280	1.73
H31TC-16	25	1	-16	25.4	39.7	31.0	4500	124.0	18000	355	2.31

Replace the hose when any deformation or damage on the hose cover are visible.  
The combination of high temperature and high pressure could reduce the hose life.

# H31ST

## ParLock Multispiral

Exceeds ISO 3862 Type 4SP –  
DIN EN 856 Type 4SP

### Primary Applications

General high pressure hydraulic applications

### Applicable Specifications

Exceeds ISO 3862 Type 4SP – DIN EN 856 Type 4SP

### Construction

Tube: Synthetic rubber  
Reinforcement: Four spirals high-tensile steel wire  
Cover: Synthetic rubber with  
special polyethylene coating

Temperature Range ..... -40 °C up to +100 °C

Exception: Air ..... max. +70 °C  
Water ..... max. +85 °C



- Interlock technology
- Extreme abrasion resistant  
**SUPER TOUGH** cover
- Reinforcement of  
four high tensile steel wires

### Recommended Fluids

Petroleum and water-glycol based fluids, lubricating oils, air and water. For air above 1.7 MPa, the hose cover must be pin-pricked.

Consult the chemical compatibility section on pages **Ab-22** to **Ab-30** for more detailed information.

### Fitting Series

External skiving (size -4 up to -8)

Internal and external skiving (size -10 up to -16)



Part Number	Hose I.D.				Hose O.D. mm	Pressure Rating				min. bend radius mm	weight kg
	DN	Inch	Size	mm		max. working pressure		min. burst pressure			
						MPa	psi	MPa	psi		
H31ST-4	6	1/4	-4	6.3	17.8	50.0	7250	200.0	29000	120	0.73
H31ST-6	10	3/8	-6	9.5	21.4	44.5	6450	178.0	25800	130	0.91
H31ST-8	12	1/2	-8	12.7	24.6	41.5	6000	166.0	24000	180	1.08
H31ST-10	16	5/8	-10	15.9	28.5	39.0	5650	156.0	22600	225	1.39
H31ST-12	20	3/4	-12	19.1	32.0	35.0	5000	140.0	20300	280	1.73
H31ST-16	25	1	-16	25.4	39.7	31.0	4500	124.0	18000	355	2.31

The combination of high temperature and high pressure could reduce the hose life.



# R35

## ParLock Multispiral

Exceeds ISO 3862 Type R13 – Parker Specifications

### Primary Applications

General high pressure hydraulic applications

### Applicable Specifications

Exceeds ISO 3862 Type R13 – Parker Specifications

### Construction

- Tube: Synthetic rubber
- Reinforcement: Four or six spirals high-tensile steel wire
- Cover: Synthetic rubber

Temperature Range ..... -40 °C up to +125 °C

- Exception: Air ..... max. +70 °C
- Water ..... max. +85 °C



- Interlock technology
- Reinforcement of four or six high tensile steel wires
- Constant working pressure of 35.0 MPa

### Recommended Fluids

Petroleum and water-glycol based fluids, lubricating oils, air and water. For air above 1.7 MPa, the hose cover must be pin-pricked.

Consult the chemical compatibility section on pages **Ab-22** to **Ab-30** for more detailed information.

### Fitting Series

Internal and external skiving (size -12, -16, -20)



Internal and external skiving (size -24, -32)



Part Number	Hose I.D.				Hose O.D. mm	Pressure Rating				min. bend radius mm	weight kg
	DN	Inch	Size	mm		max. working pressure		min. burst pressure			
						MPa	psi	MPa	psi		
R35-12	20	3/4	-12	19.1	32.00	35.0	5000	140.0	20000	220	1.5
R35-16	25	1	-16	25.4	39.35	35.0	5000	140.0	20000	280	2.2
R35-20	32	1-1/4	-20	31.8	45.50	35.0	5000	140.0	20000	380	2.6
R35-24	40	1-1/2	-24	38.1	57.30	35.0	5000	140.0	20000	480	4.8
R35-32	50	2	-32	50.8	71.10	35.0	5000	140.0	20000	600	6.7

The combination of high temperature and high pressure could reduce the hose life.

# R35TC

## ParLock Multispiral

Exceeds ISO 3862 Type R13 – Parker Specifications

### Primary Applications

General high pressure hydraulic applications

### Type Approvals

Details please find on pages **Ab-14** and **Ab-15**

### Applicable Specifications

Exceeds ISO 3862 Type R13 – Parker Specifications

### Construction

Tube: Synthetic rubber  
Reinforcement: Four or six spirals high-tensile steel wire  
Cover: High abrasion resistance  
MSHA approved synthetic rubber

Temperature Range ..... -40 °C up to +125 °C

Exception: Air ..... max. +70 °C  
Water ..... max. +85 °C



- Interlock technology
- Reinforcement of four or six high tensile steel wires
- Constant working pressure of 35.0 MPa
- Highly abrasion resistant **TOUGH COVER**
- MSHA approved
- Hose is suitable for temporary immersion in mineral oil up to 70 °C with frequent inspections

### Recommended Fluids

Petroleum and water-glycol based fluids, lubricating oils, air and water. For air above 1.7 MPa, the hose cover must be pin-pricked.

Consult the chemical compatibility section on pages **Ab-22** to **Ab-30** for more detailed information.

### Fitting Series

Internal and external skiving (size -12, -16, -20) 

Internal and external skiving (size -24, -32, -40) 

Part Number	Hose I.D.				Hose O.D. mm	Pressure Rating				min. bend radius mm	weight kg
	DN	Inch	Size	mm		max. working pressure		min. burst pressure			
						MPa	psi	MPa	psi		
R35TC-12	20	3/4	-12	19.1	32.00	35.0	5000	140.0	20000	220	1.5
R35TC-16	25	1	-16	25.4	39.35	35.0	5000	140.0	20000	280	2.2
R35TC-20	32	1-1/4	-20	31.8	45.50	35.0	5000	140.0	20000	380	2.6
R35TC-24	40	1-1/2	-24	38.1	57.30	35.0	5000	140.0	20000	480	4.8
R35TC-32	50	2	-32	50.8	71.10	35.0	5000	140.0	20000	600	6.7
R35TC-40	65	2 1/2	-40	63.5	84.50	35.0	5000	140.0	20000	800	9.0

Replace the hose when any deformation or damage on the hose cover are visible.  
The combination of high temperature and high pressure could reduce the hose life.

# R42

## ParLock Multispiral

Exceeds ISO 3862 Type R15 – Parker Specifications

### Primary Applications

General high pressure hydraulic applications

### Type Approvals

Details please find on pages **Ab-14** and **Ab-15**

### Applicable Specifications

Exceeds ISO 3862 Type R15 – Parker Specifications

### Construction

Tube: Synthetic rubber  
Reinforcement: Four or six spirals high-tensile steel wire  
Cover: Synthetic rubber

Temperature Range ..... -40 °C up to +125 °C

Exception: Air ..... max. +70 °C  
Water ..... max. +85 °C



- Interlock technology
- Reinforcement of four or six high tensile steel wires
- Constant working pressure of 42.0 MPa

### Recommended Fluids

Petroleum and water-glycol based fluids, lubricating oils, air and water. For air above 1.7 MPa, the hose cover must be pin-pricked.

Consult the chemical compatibility section on pages **Ab-22** to **Ab-30** for more detailed information.

### Fitting Series

Internal and external skiving (size -10, -12, -16)



Internal and external skiving (size -20, -24, -32)



Part Number	Hose I.D.				Hose O.D. mm	Pressure Rating				min. bend radius mm	weight kg
	DN	Inch	Size	mm		max. working pressure		min. burst pressure			
						MPa	psi	MPa	psi		
R42-10	16	5/8	-10	15.9	28.50	42.0	6000	168.0	24000	225	1.39
R42-12	20	3/4	-12	19.1	32.00	42.0	6000	168.0	24000	280	1.70
R42-16	25	1	-16	25.4	39.00	42.0	6000	168.0	24000	300	2.30
R42-20	32	1-1/4	-20	31.8	50.75	42.0	6000	168.0	24000	400	3.80
R42-24	40	1-1/2	-24	38.1	57.00	42.0	6000	168.0	24000	500	4.80
R42-32	50	2	-32	50.8	71.50	42.0	6000	168.0	24000	700	7.00

The combination of high temperature and high pressure could reduce the hose life.

# R42TC

## ParLock Multispiral

Exceeds ISO 3862 Type R15 – Parker Specifications

### Primary Applications

General high pressure hydraulic applications

### Type Approvals

Details please find on pages **Ab-14** and **Ab-15**

### Applicable Specifications

Exceeds ISO 3862 Type R15 – Parker Specifications

### Construction

Tube: Synthetic rubber  
Reinforcement: Four or six spirals high-tensile steel wire  
Cover: High abrasion resistance  
MSHA approved synthetic rubber

Temperature Range ..... -40 °C up to +125 °C

Exception: Air ..... max. +70 °C  
Water ..... max. +85 °C



- Interlock technology
- Reinforcement of four or six high tensile steel wires
- Constant working pressure of 42.0 MPa
- Highly abrasion resistant **TOUGH COVER**
- MSHA approved
- Hose is suitable for temporary immersion in mineral oil up to 70 °C with frequent inspections

### Recommended Fluids

Petroleum and water-glycol based fluids, lubricating oils, air and water. For air above 1.7 MPa, the hose cover must be pin-pricked.

Consult the chemical compatibility section on pages **Ab-22** to **Ab-30** for more detailed information.

### Fitting Series

Internal and external skiving (size -10, -12, -16)



Internal and external skiving (size -20, -24, -32)



Part Number	Hose I.D.				Hose O.D. mm	Pressure Rating				min. bend radius mm	weight kg
	DN	Inch	Size	mm		max. working pressure		min. burst pressure			
						MPa	psi	MPa	psi		
R42TC-10	16	5/8	-10	15.9	28.50	42.0	6000	168.0	24000	225	1.39
R42TC-12	20	3/4	-12	19.1	32.00	42.0	6000	168.0	24000	280	1.70
R42TC-16	25	1	-16	25.4	39.00	42.0	6000	168.0	24000	300	2.30
R42TC-20	32	1-1/4	-20	31.8	50.75	42.0	6000	168.0	24000	400	3.80
R42TC-24	40	1-1/2	-24	38.1	57.00	42.0	6000	168.0	24000	500	4.80
R42TC-32	50	2	-32	50.8	71.50	42.0	6000	168.0	24000	700	7.00

Replace the hose when any deformation or damage on the hose cover are visible.  
The combination of high temperature and high pressure could reduce the hose life.

# R42ST

## ParLock Multispiral

Exceeds ISO 3862 Type R15 – Parker Specifications

### Primary Applications

General high pressure hydraulic applications

### Applicable Specifications

Exceeds ISO 3862 Type R15 – Parker Specifications

### Construction

- Tube: Synthetic rubber
- Reinforcement: Four or six spirals high-tensile steel wire
- Cover: Synthetic rubber with special polyethylene coating

Temperature Range ..... -40 °C up to +125 °C

- Exception: Air ..... max. +70 °C
- Water ..... max. +85 °C



- Interlock technology
- Extreme abrasion resistant **SUPER TOUGH** cover
- Reinforcement of four or six high tensile steel wires
- Constant working pressure of 42.0 MPa

### Recommended Fluids

Petroleum and water-glycol based fluids, lubricating oils, air and water. For air above 1.7 MPa, the hose cover must be pin-pricked.

Consult the chemical compatibility section on pages **Ab-22** to **Ab-30** for more detailed information.

### Fitting Series

Internal and external skiving (size -10, -12, -16)



Internal and external skiving (size -20, -24, -32)



Part Number	Hose I.D.				Hose O.D. mm	Pressure Rating				min. bend radius mm	weight kg
	DN	Inch	Size	mm		max. working pressure		min. burst pressure			
						MPa	psi	MPa	psi		
R42ST-10	16	5/8	-10	15.9	28.50	42.0	6000	168.0	24000	225	1.39
R42ST-12	20	3/4	-12	19.1	32.00	42.0	6000	168.0	24000	280	1.70
R42ST-16	25	1	-16	25.4	39.00	42.0	6000	168.0	24000	300	2.30
R42ST-20	32	1-1/4	-20	31.8	50.75	42.0	6000	168.0	24000	400	3.80
R42ST-24	40	1-1/2	-24	38.1	57.00	42.0	6000	168.0	24000	500	4.80
R42ST-32	50	2	-32	50.8	71.50	42.0	6000	168.0	24000	700	7.00

The combination of high temperature and high pressure could reduce the hose life.

# R50TC

## ParLock Multispiral

Exceeds ISO 3862 Type R15 –  
Parker Specifications

### Primary Applications

Mobile hydraulic equipment and agricultural machines with typically large constructions.

### Type Approvals

Details please find on pages **Ab-14** and **Ab-15**

### Applicable Specifications

Exceeds ISO 3862 Type R15, Parker Specifications

### Construction

Tube: Synthetic rubber  
Reinforcement: Four or six spirals high-tensile steel wire  
Cover: High abrasion resistance  
MSHA approved synthetic rubber

Temperature Range ..... -40 °C up to +100 °C

Exception: Air ..... max. +70 °C  
Water ..... max. +85 °C



- Interlock technology
- Reinforcement of four or six high tensile steel wires
- Constant working pressure of 50.0 MPa
- Highly abrasion resistant **TOUGH COVER**
- MSHA approved
- Hose is suitable for temporary immersion in mineral oil up to 70 °C with frequent inspections

### Recommended Fluids

Petroleum and water-glycol based fluids, lubricating oils, air and water. For air above 1.7 MPa, the hose cover must be pin-pricked.

Consult the chemical compatibility section on pages **Ab-22** to **Ab-30** for more detailed information.

Fitting Series Internal and external skiving size -10 up to -16 (R50TC-16-SP4)

R50TC-16-SP6

R50TC-20











Part Number	Hose I.D.				Hose O.D. mm	Pressure Rating				min. bend radius mm	weight kg
	DN	Inch	Size	mm		max. working pressure		min. burst pressure			
						MPa	psi	MPa	psi		
R50TC-10	16	5/8	-10	15.9	28.50	50.0	7250	200.0	29000	225	1.48
R50TC-12	20	3/4	-12	19.1	32.00	50.0	7250	200.0	29000	270	1.85
R50TC-16-SP4	25	1	-16	25.4	38.40	50.0	7250	200.0	29000	300	2.70
R50TC-16-SP6	25	1	-16	25.4	39.00	50.0	7250	200.0	29000	330	3.50
R50TC-20	32	1-1/4	-20	31.8	52.60	50.0	7250	200.0	29000	450	5.00







Replace the hose when any deformation or damage on the hose cover are visible.  
The combination of high temperature and high pressure could reduce the hose life.







## DIN – Metric

Page Db-1 – Db-4			
<p><b>CA</b> Db-1</p>  <p>Female Metric 24° Light Series with O-Ring Swivel – Straight ISO 12151-2-SWS-L – DKOL</p>	<p><b>CE</b> Db-1</p>  <p>Female Metric 24° Light Series with O-Ring Swivel – 45° Elbow ISO 12151-2-SWE 45°-L – DKOL 45°</p>	<p><b>CF</b> Db-2</p>  <p>Female Metric 24° Light Series with O-Ring Swivel – 90° Elbow ISO 12151-2-SWE-L – DKOL 90°</p>	<p><b>D0</b> Db-2</p>  <p>Male Metric 24° Light Series – Rigid Straight ISO 12151-2-S-L – CEL</p>
<p><b>C9</b> Db-3</p>  <p>Female Metric 24° – Swivel Heavy Series with O-Ring Straight ISO 12151-2-SWS-S – DKOS</p>	<p><b>0C</b> Db-3</p>  <p>Female Metric 24° – Swivel Heavy Series with O-Ring 45° Elbow ISO 12151-2 – SWE 45°-S – DKOS 45°</p>	<p><b>1C</b> Db-4</p>  <p>Female Metric 24° – Swivel Heavy Series with O-Ring 90° Elbow ISO 12151-2-SWE-S – DKOS 90°</p>	<p><b>D2</b> Db-4</p>  <p>Male Metric 24° – Rigid Heavy Series – Straight ISO 12151-2-S-S – CES</p>

## BSP







Page Db-5 – Db-7			
<p><b>92</b> Db-5</p>  <p>Female BSP Parallel Pipe Swivel – Straight (60° Cone) BS5200-A – DKR</p>	<p><b>B1</b> Db-5</p>  <p>Female BSP Parallel Pipe Swivel 45° Elbow (60° Cone) BS 5200-D – DKR 45°</p>	<p><b>B2</b> Db-6</p>  <p>Female BSP Parallel Pipe Swivel 90° Elbow (60° Cone) BS 5200-B – DKR 90°</p>	<p><b>EA</b> Db-6</p>  <p>BSP Swivel Female with O-Ring (60° Cone) BS 5200 – ISO 12151-6 – DKOR</p>
<p><b>EC</b> Db-7</p>  <p>BSP Swivel Female with O-Ring 90° Elbow (60° Cone) BS 5200 – ISO 12151-6 – DKOR 90°</p>	<p><b>D9</b> Db-7</p>  <p>Male BSP Parallel Pipe Rigid – Straight (60° Cone) BS5200 – AGR</p>		

## SAE







Page Db-8 – Db-10			
<p><b>01</b> Db-8</p>  <p>Male NPTF Pipe Rigid – Straight SAE J476A / J516 – AGN</p>	<p><b>03</b> Db-8</p>  <p>Male JIC 37° – Rigid Straight ISO12151-5-S – AGJ</p>	<p><b>06</b> Db-9</p>  <p>Female JIC 37° – Swivel Straight ISO12151-5-SWS – DKJ</p>	<p><b>37</b> Db-10</p>  <p>Female JIC 37° – Swivel 45° Elbow ISO 12151-5-SWE 45° – DKJ 45°</p>
<p><b>39/3W</b> Db-10</p>  <p>Female JIC 37° SAE 45° – Dual Flare Swivel Female 90° Elbow ISO 12151-5-SWES – DKJ 90°</p>			



## Flange

Page Db-11 – Db-13			
<p><b>15</b> Db-11</p>  <p>SAE Code 61 – Flange Head Straight ISO 12151-3-S-L – SFL 3000 psi</p>	<p><b>17</b> Db-11</p>  <p>SAE Code 61 – Flange Head 45° Elbow ISO 12151-3 – E45 – L – SFL 45° 3000 psi</p>	<p><b>19</b> Db-12</p>  <p>SAE Code 61 – Flange Head 90° Elbow ISO 12151-3 – E – L – SFL 90° 3000 psi</p>	<p><b>6A</b> Db-12</p>  <p>SAE Code 62 Flange Straight ISO 12151-3-S-S – SFS 6000 psi</p>
<p><b>6F</b> Db-13</p>  <p>SAE Code 62 Flange 45° Elbow – Heavy Series ISO 12151-3 – E45-S – SFS 45° 6000 psi</p>	<p><b>6N</b> Db-13</p>  <p>SAE Code 62 Flange 90° Elbow ISO 12151-3 – E-S – SFS 90° 6000 psi</p>		



## ORFS

Page Db-14 – Db-16			
<p><b>JC</b> Db-14</p>  <p>Female ORFS Swivel – Straight Short ISO 12151-1 – SWSA SAE J516 – ORFS</p>	<p><b>JS</b> Db-14</p>  <p>ORFS Swivel Female (Long) ISO 12151-1-SWSB SAE J516 – ORFS</p>	<p><b>J7</b> Db-15</p>  <p>Female ORFS – Swivel 45° Elbow ISO 12151-1 – SWE 45° SAE J516 – ORFS 45°</p>	<p><b>J9</b> Db-15</p>  <p>Female ORFS – Swivel 90° Elbow – Short Drop ISO 12151-1 – SWES SAE J516 – ORFS 90°</p>
<p><b>J1</b> Db-16</p>  <p>Female ORFS – Swivel 90° Elbow – Long Drop ISO 12151-1 – SWEL SAE J516 – ORFS 90° L</p>	<p><b>JM</b> Db-16</p>  <p>ORFS Male ISO 12151-1-S – SAE J516</p>		



## JIS

Page Db-17
<p><b>MU</b> Db-17</p>  <p>Female Metric – Swivel Straight (30° Flare) JIS B8363 – MU</p>

## French Standard

Page Db-18	
<p><b>FG</b> Db-18</p>  <p>Male French Gas Series Rigid – Straight (24° Cone)</p>	<p><b>F4</b> Db-18</p>  <p>Female French Gas Series Swivel – Straight (Ball Nose)</p>

## Others

Page Db-19	
<p><b>XU</b> Db-19</p>  <p>Female Metric – Swivel Straight (30° Flare) JIS B8363</p>	<p><b>XY</b> Db-19</p>  <p>Female Metric – Swivel 90° Elbow (30° Flare) JIS B8363</p>



## CA Female Metric 24° Light Series with O-Ring Swivel – Straight

ISO 12151-2-SWS-L – DKOL

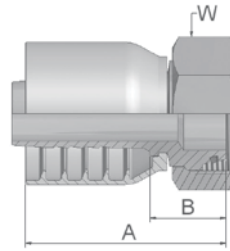

XXXXX-XX-XX Part Number 70	Hose I.D.				Thread metric	Tube O.D. mm	A mm	B mm	W mm
	DN	Inch	Size	mm					
1CA70-10-6	10	3/8	-6	9.5	M16x1.5	10	53	24	19
1CA70-12-6	10	3/8	-6	9.5	M18x1.5	12	53	24	22
1CA70-15-8	12	1/2	-8	12.7	M22x1.5	15	62	27	27
1CA70-18-8	12	1/2	-8	12.7	M26x1.5	18	57	22	32
1CA70-15-10	16	5/8	-10	15.9	M22x1.5	15	64	27	27
1CA70-18-10	16	5/8	-10	15.9	M26x1.5	18	62	26	32
1CA70-22-10	16	5/8	-10	15.9	M30x2	22	64	24	36
1CA70-18-12	20	3/4	-12	19.1	M26x1.5	18	65	26	32
1CA70-22-12	20	3/4	-12	19.1	M30x2	22	63	24	36
1CA70-28-12	20	3/4	-12	19.1	M36x2	28	66	26	41
1CA70-28-16	25	1	-16	25.4	M36x2	28	78	33	41
1CA70-35-16	25	1	-16	25.4	M45x2	35	76	31	50

Fittings with standard O-ring seals can be used for temperatures from -30 °C up to +105 °C.  
Find O-rings in section E. Special O-rings are available on request.  
Attention: Hose assembly pressure is reduced; see page Ab-8

## CE Female Metric 24° Light Series with O-Ring Swivel – 45° Elbow

ISO 12151-2-SWE 45°-L – DKOL 45°

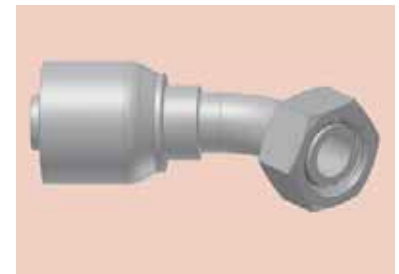
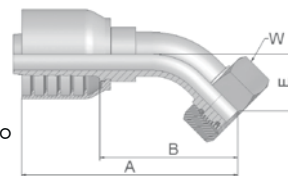

XXXXX-XX-XX Part Number 70	Hose I.D.				Thread metric	Tube O.D. mm	A mm	B mm	E mm	W mm
	DN	Inch	Size	mm						
1CE70-12-6	10	3/8	-6	9.5	M18x1.5	12	69	40	20	22
1CE70-15-8	12	1/2	-8	12.7	M22x1.5	15	85	50	24	27
1CE70-18-10	16	5/8	-10	15.9	M26x1.5	18	89	49	23	32
1CE70-22-12	20	3/4	-12	19.1	M30x2	22	98	58	26	36
1CE70-28-16	25	1	-16	25.4	M36x2	28	125	80	34	41

Fittings with standard O-ring seals can be used for temperatures from -30 °C up to +105 °C.  
Find O-rings in section E. Special O-rings are available on request.  
Attention: Hose assembly pressure is reduced; see page Ab-8

Approved fitting series for hose types:

Also available in stainless steel. Details can be found in CAT 4400.1/UK

70 371LT 372 372RH 372TC 701 F42-8

## CF Female Metric 24° Light Series with O-Ring Swivel – 90° Elbow

ISO 12151-2-SWE-L – DKOL 90°

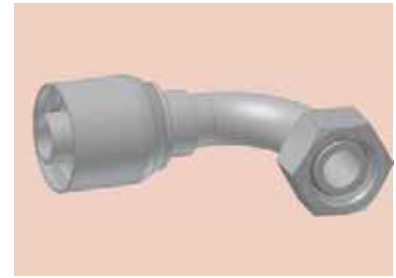
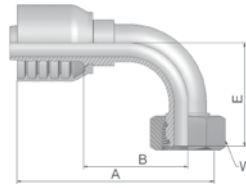

XXXXX-XX-XX Part Number 70	Hose I.D.				Thread metric	Tube O.D. mm	A mm	B mm	E mm	W mm
	DN	Inch	Size	mm						
1CF70-10-6	10	3/8	-6	9.5	M16x1.5	10	67	38	38	19
1CF70-12-6	10	3/8	-6	9.5	M18x1.5	12	67	38	37	22
1CF70-15-8	12	1/2	-8	12.7	M22x1.5	15	74	39	45	27
1CF70-18-8	12	1/2	-8	12.7	M26x1.5	18	71	36	40	32
1CF70-15-10	16	5/8	-10	15.9	M22x1.5	15	79	42	50	27
1CF70-18-10	16	5/8	-10	15.9	M26x1.5	18	79	42	49	32
1CF70-18-12	20	3/4	-12	19.1	M26x1.5	18	89	50	56	32
1CF70-22-12	20	3/4	-12	19.1	M30x2	22	89	49	55	36
1CF70-28-16	25	1	-16	25.4	M36x2	28	113	68	73	41
1CF70-35-16	25	1	-16	25.4	M45x2	35	115	68	69	50

Fittings with standard O-ring seals can be used for temperatures from -30 °C up to +105 °C.  
Find O-rings in section E. Special O-rings are available on request.  
Attention: Hose assembly pressure is reduced; see page Ab-8

## D0 Male Metric 24° Light Series – Rigid Straight

ISO 12151-2-S-L – CEL

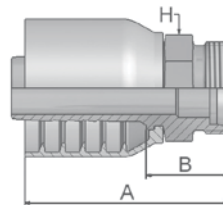

XXXXX-XX-XX Part Number 70	Hose I.D.				Thread metric	Tube O.D. mm	A mm	B mm	H mm
	DN	Inch	Size	mm					
1D070-15-8	12	1/2	-8	12.7	M22x1.5	15	60	26	22
1D070-18-10	16	5/8	-10	15.9	M26x1.5	18	65	28	27
1D070-22-12	20	3/4	-12	19.1	M30x2	22	69	30	30
1D070-28-16	25	1	-16	25.4	M36x2	28	79	32	36

Attention: Hose assembly pressure is reduced; see page Ab-8

Approved **fitting series** for hose types:

Also available in stainless steel. Details can be found in CAT 4400.1/UK

70 371LT 372 372RH 372TC 701 F42-8

## C9 Female Metric 24° – Swivel Heavy Series with O-Ring Straight

ISO 12151-2-SWS-S – DKOS

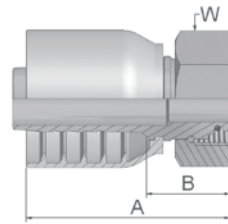

XXXXX-XX-XX Part Number 70	Hose I.D.				Thread metric	Tube O.D. mm	A mm	B mm	W mm
	DN	Inch	Size	mm					
1C970-8-6	10	3/8	-6	9.5	M16x1.5	8	53	24	19
1C970-12-6	10	3/8	-6	9.5	M20x1.5	12	52	22	24
1C970-14-6	10	3/8	-6	9.5	M22x1.5	14	53	24	27
1C970-12-8	12	1/2	-8	12.7	M20x1.5	12	60	25	24
1C970-16-8	12	1/2	-8	12.7	M24x1.5	16	59	24	30
1C970-20-8	12	1/2	-8	12.7	M30x2	20	59	25	36
1C970-16-10	16	5/8	-10	15.9	M24x1.5	16	67	27	30
1C970-20-10	16	5/8	-10	15.9	M30x2	20	64	27	36
1C970-25-10	16	5/8	-10	15.9	M36x2	25	65	29	46
1C970-20-12	20	3/4	-12	19.1	M30x2	20	67	27	36
1C970-25-12	20	3/4	-12	19.1	M36x2	25	68	28	46
1C970-25-16	25	1	-16	25.4	M36x2	25	78	33	46
1C970-30-16	25	1	-16	25.4	M42x2	30	80	33	50

Fittings with standard O-ring seals can be used for temperatures from -30 °C up to +105 °C. Find O-rings in section E. Special O-rings are available on request.

## OC Female Metric 24° – Swivel Heavy Series with O-Ring 45° Elbow

ISO 12151-2 – SWE 45°-S – DKOS 45°

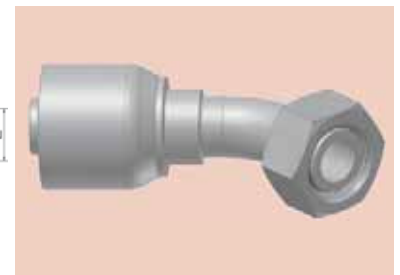
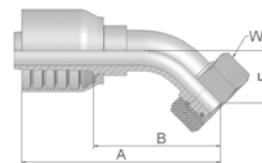

XXXXX-XX-XX Part Number 70	Hose I.D.				Thread metric	Tube O.D. mm	A mm	B mm	E mm	W mm
	DN	Inch	Size	mm						
10C70-12-6	10	3/8	-6	9.5	M20x1.5	12	69	40	20	24
10C70-14-6	10	3/8	-6	9.5	M22x1.5	14	76	46	20	27
10C70-16-8	12	1/2	-8	12.7	M24x1.5	16	83	48	24	30
10C70-16-10	16	5/8	-10	15.9	M24x1.5	16	89	49	23	30
10C70-20-10	16	5/8	-10	15.9	M30x2	20	91	52	25	36
10C70-25-10	16	5/8	-10	15.9	M36x2	25	92	56	27	46
10C70-20-12	20	3/4	-12	19.1	M30x2	20	100	60	29	36
10C70-25-12	20	3/4	-12	19.1	M36x2	25	101	61	30	46
10C70-25-16	25	1	-16	25.4	M36x2	25	127	75	32	46
10C70-30-16	25	1	-16	25.4	M42x2	30	126	79	36	50

Fittings with standard O-ring seals can be used for temperatures from -30 °C up to +105 °C. Find O-rings in section E. Special O-rings are available on request.

Approved fitting series for hose types:

Also available in stainless steel. Details can be found in CAT 4400.1/UK

70 371LT 372 372RH 372TC 701 F42-8

# 1C Female Metric 24° – Swivel Heavy Series with O-Ring 90° Elbow

ISO 12151-2-SWE-S – DKOS 90°

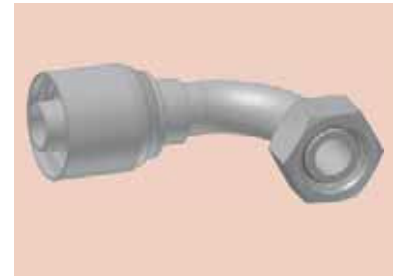
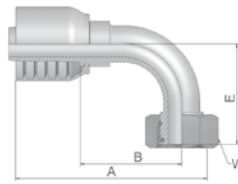

XXXXX-XX-XX Part Number 70	Hose I.D.				Thread metric	Tube O.D. mm	A mm	B mm	E mm	W mm
	DN	Inch	Size	mm						
11C70-8-6	10	3/8	-6	9.5	M16x1.5	8	67	38	37	19
11C70-12-6	10	3/8	-6	9.5	M20x1.5	12	67	38	37	24
11C70-14-6	10	3/8	-6	9.5	M22x1.5	14	65	35	37	27
11C70-16-8	12	1/2	-8	12.7	M24x1.5	16	72	37	45	30
11C70-20-8	12	1/2	-8	12.7	M30x2	20	75	40	46	36
11C70-16-10	16	5/8	-10	15.9	M24x1.5	16	79	40	45	30
11C70-20-10	16	5/8	-10	15.9	M30x2	20	79	40	48	36
11C70-25-10	16	5/8	-10	15.9	M36x2	25	85	46	52	46
11C70-25-12	20	3/4	-12	19.1	M36x2	25	89	49	59	46
11C70-30-12	20	3/4	-12	19.1	M42x2	30	89	50	60	50
11C70-25-16	25	1	-16	25.4	M36x2	25	115	68	70	46
11C70-30-16	25	1	-16	25.4	M42x2	30	115	68	76	50

Fittings with standard O-ring seals can be used for temperatures from -30 °C up to +105 °C.  
Find O-rings in section E. Special O-rings are available on request.

# D2 Male Metric 24° – Rigid Heavy Series – Straight

ISO 12151-2-S-S – CES

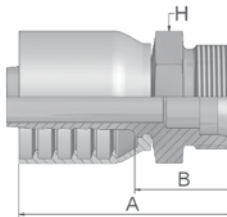

XXXXX-XX-XX Part Number 70	Hose I.D.				Thread metric	Tube O.D. mm	A mm	B mm	H mm
	DN	Inch	Size	mm					
1D270-12-6	10	3/8	-6	9.5	M20x1.5	12	53	24	22
1D270-14-6	10	3/8	-6	9.5	M22x1.5	14	55	25	22
1D270-16-8	12	1/2	-8	12.7	M24x1.5	16	62	28	24
1D270-20-8	12	1/2	-8	12.7	M30x2	20	67	32	30
1D270-20-10	16	5/8	-10	15.9	M30x2	20	75	32	30
1D270-20-12	20	3/4	-12	19.1	M30x2	20	72	33	30
1D270-25-12	20	3/4	-12	19.1	M36x2	25	74	35	36
1D270-25-16	25	1	-16	25.4	M36x2	25	84	37	36
1D270-30-16	25	1	-16	25.4	M42x2	30	85	40	46

Approved fitting series for hose types:

Also available in stainless steel. Details can be found in CAT 4400.1/UK

70 371LT 372 372RH 372TC 701 F42-8

## 92 Female BSP Parallel Pipe Swivel – Straight (60° Cone)

BS5200-A – DKR

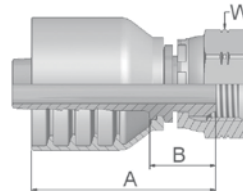

XXXXX-XX-XX Part Number 70	Hose I.D.				Thread BSP	A mm	B mm	W mm
	DN	Inch	Size	mm				
19270-6-6	10	3/8	-6	9.5	3/8x19	49	20	22
19270-8-6	10	3/8	-6	9.5	1/2x14	51	22	27
19270-8-8	12	1/2	-8	12.7	1/2x14	57	22	27
19270-10-8	12	1/2	-8	12.7	5/8x14	55	20	30
19270-10-10	16	5/8	-10	15.9	5/8x14	57	21	30
19270-12-10	16	5/8	-10	15.9	3/4x14	61	22	32
19270-12-12	20	3/4	-12	19.1	3/4x14	61	22	32
19270-16-12	20	3/4	-12	19.1	1x11	63	24	41
19270-16-16	25	1	-16	25.4	1x11	76	27	41

## B1 Female BSP Parallel Pipe Swivel 45° Elbow (60° Cone)

BS 5200-D – DKR 45°

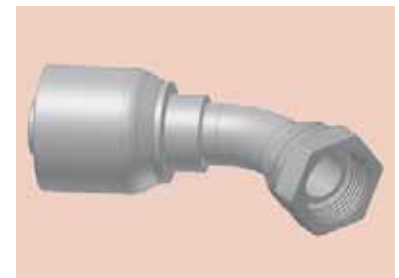
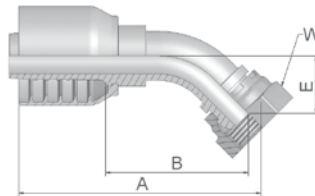

XXXXX-XX-XX Part Number 70	Hose I.D.				Thread BSP	A mm	B mm	E mm	W mm
	DN	Inch	Size	mm					
1B170-4-6	10	3/8	-6	9.5	1/4x19	68	39	19	19
1B170-6-6	10	3/8	-6	9.5	3/8x19	67	37	17	22
1B170-8-6	10	3/8	-6	9.5	1/2x14	68	39	19	27
1B170-8-8	12	1/2	-8	12.7	1/2x14	79	45	20	27
1B170-10-8	12	1/2	-8	12.7	5/8x14	78	43	19	30
1B170-10-10	16	5/8	-10	15.9	5/8x14	90	50	24	30
1B170-12-10	16	5/8	-10	15.9	3/4x14	88	49	22	32
1B170-12-12	20	3/4	-12	19.1	3/4x14	96	57	25	32
1B170-16-12	20	3/4	-12	19.1	1x11	95	56	24	41
1B170-16-16	25	1	-16	25.4	1x11	120	75	31	41

Approved fitting series for hose types:

Also available in stainless steel. Details can be found in CAT 4400.1/UK

70 371LT 372 372RH 372TC 701 F42-8

## B2 Female BSP Parallel Pipe Swivel 90° Elbow (60° Cone)

BS 5200-B – DKR 90°

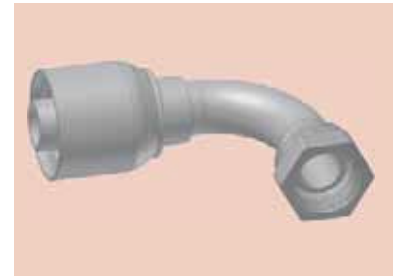
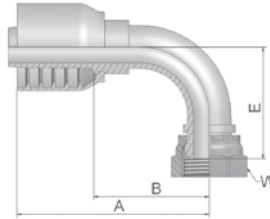

XXXXX-XX-XX Part Number 70	Hose I.D.				Thread BSP	A mm	B mm	E mm	W mm
	DN	Inch	Size	mm					
1B270-6-6	10	3/8	-6	9.5	3/8x19	66	37	33	22
1B270-8-6	10	3/8	-6	9.5	1/2x14	66	37	35	27
1B270-8-8	12	1/2	-8	12.7	1/2x14	70	35	39	27
1B270-10-8	12	1/2	-8	12.7	5/8x14	74	39	38	30
1B270-10-10	16	5/8	-10	15.9	5/8x14	81	44	47	30
1B270-12-10	16	5/8	-10	15.9	3/4x14	92	52	59	32
1B270-16-10	16	5/8	-10	15.9	1x11	86	46	44	41
1B270-12-12	20	3/4	-12	19.1	3/4x14	89	50	53	32
1B270-16-12	20	3/4	-12	19.1	1x11	89	49	51	41
1B270-16-16	25	1	-16	25.4	1x11	116	69	69	41

## EA BSP Swivel Female with O-Ring (60° Cone)

BS 5200 – ISO 12151-6 – DKOR

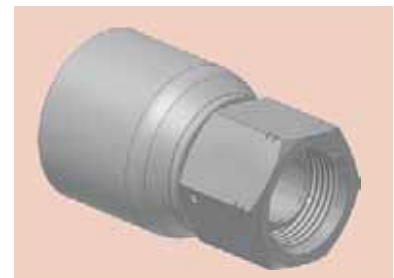
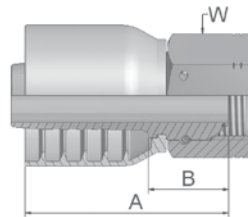

XXXXX-XX-XX Part Number 70	Hose I.D.				Thread BSP	A mm	B mm	W mm
	DN	Inch	Size	mm				
1EA70-8-8	12	1/2	-8	12.7	1/2x14	56	21	27
1EA70-12-12	20	3/4	-12	19.1	3/4x14	63	23	32
1EA70-16-16	25	1	-16	25.4	1x11	76	31	41

Fittings with standard O-ring seals can be used for temperatures from -30 °C up to +105 °C.  
Find O-rings in section E. Special O-rings are available on request.

Approved **fitting series** for hose types:

Also available in stainless steel. Details can be found in CAT 4400.1/UK

70 371LT 372 372RH 372TC 701 F42-8



## EC BSP Swivel Female with O-Ring 90° Elbow (60° Cone)

BS 5200 – ISO 12151-6 – DKOR 90°

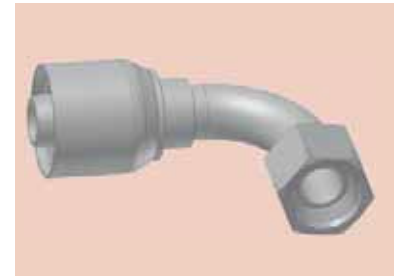
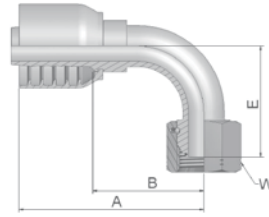

XXXXX-XX-XX Part Number 70	Hose I.D.				Thread BSP	A mm	B mm	E mm	W mm
	DN	Inch	Size	mm					
1EC70-8-8	12	1/2	-8	12.7	1/2x14	71	36	40	27
1EC70-12-12	20	3/4	-12	19.1	3/4x14	89	50	55	32
1EC70-16-16	25	1	-16	25.4	1x11	115	68	71	41

Fittings with standard O-ring seals can be used for temperatures from -30 °C up to +105 °C.  
Find O-rings in section E. Special O-rings are available on request.

## D9 Male BSP Parallel Pipe Rigid – Straight (60° Cone)

BS5200 – AGR

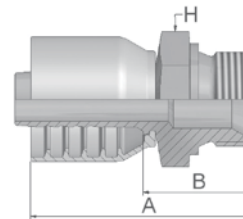

XXXXX-XX-XX Part Number 70	Hose I.D.				Thread BSP	A mm	B mm	H mm
	DN	Inch	Size	mm				
1D970-6-6	10	3/8	-6	9.5	3/8x19	57	28	22
1D970-8-6	10	3/8	-6	9.5	1/2x14	60	31	27
1D970-8-8	12	1/2	-8	12.7	1/2x14	62	28	27
1D970-10-8	12	1/2	-8	12.7	5/8x14	70	36	30
1D970-12-8	12	1/2	-8	12.7	3/4x14	69	35	32
1D970-10-10	16	5/8	-10	15.9	5/8x14	75	36	30
1D970-12-10	16	5/8	-10	15.9	3/4x14	72	35	32
1D970-12-12	20	3/4	-12	19.1	3/4x14	70	30	32
1D970-16-12	20	3/4	-12	19.1	1x11	77	38	41
1D970-16-16	25	1	-16	25.4	1x11	85	40	41

Approved fitting series for hose types:

Also available in stainless steel. Details can be found in CAT 4400.1/UK

70 371LT 372 372RH 372TC 701 F42-8

## 01 Male NPTF Pipe Rigid – Straight

SAE J476A / J516 – AGN

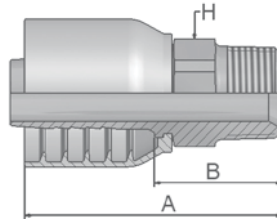

XXXXX-XX-XX Part Number 70	Hose I.D.				Thread NPTF	A mm	B mm	H mm
	DN	Inch	Size	mm				
10170-6-6-SM	10	3/8	-6	9.5	3/8x18	60	31	19
10170-12-8-SM	12	1/2	-8	12.7	3/4x14	68	33	27
10170-8-10-SM	16	5/8	-10	15.9	1/2x14	75	38	24
10170-12-10-SM	16	5/8	-10	15.9	3/4x14	71	34	27
10170-12-12-SM	20	3/4	-12	19.1	3/4x14	79	39	27
10170-16-12-SM	20	3/4	-12	19.1	1x11-1/2	79	39	36
10170-16-16-SM	25	1	-16	25.4	1x11-1/2	93	46	36

## 03 Male JIC 37° – Rigid Straight

ISO12151-5-S – AGJ

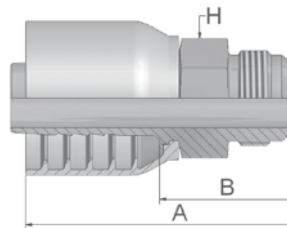

XXXXX-XX-XX Part Number 70	Hose I.D.				Thread UNF	A mm	B mm	H mm
	DN	Inch	Size	mm				
10370-6-6-SM	10	3/8	-6	9.5	9/16x18	60	31	19
10370-8-6-SM	10	3/8	-6	9.5	3/4x16	59	29	19
10370-8-8-SM	12	1/2	-8	12.7	3/4x16	68	33	22
10370-10-8-SM	12	1/2	-8	12.7	7/8x14	67	32	24
10370-12-8-SM	12	1/2	-8	12.7	1-1/16x12	71	36	27
10370-10-10-SM	16	5/8	-10	15.9	7/8x14	75	38	24
10370-12-10-SM	16	5/8	-10	15.9	1-1/16x12	75	36	27
10370-12-12-SM	20	3/4	-12	19.1	1-1/16x12	82	42	27
10370-16-12-SM	20	3/4	-12	19.1	1-5/16x12	77	38	36
10370-16-16-SM	25	1	-16	25.4	1-5/16x12	94	47	36

Approved **fitting series** for hose types:

Also available in stainless steel. Details can be found in CAT 4400.1/UK

SM: Metric Hexagon

70 371LT 372 372RH 372TC 701 F42-8

06

**Female JIC 37° – Swivel  
Straight**

ISO12151-5-SWS – DKJ

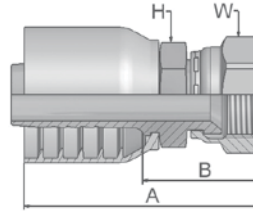

XXXXX-XX-XX Part Number 70	Hose I.D.				Thread UNF	A mm	B mm	H mm	W mm
	DN	Inch	Size	mm					
10670-6-6-SM	10	3/8	-6	9.5	9/16x18	58	29	17	19
10670-8-6-SM	10	3/8	-6	9.5	3/4x16	61	32	19	22
10670-10-6-SM*	10	3/8	-6	9.5	7/8x14	64	35	22	27
10670-8-8-SM*	12	1/2	-8	12.7	3/4x16	67	32	22	22
10670-10-8-SM*	12	1/2	-8	12.7	7/8x14	70	35	22	27
10670-12-8-SM	12	1/2	-8	12.7	1-1/16x12	71	36	27	32
10670-8-10-SM*	16	5/8	-10	15.9	3/4x16	73	36	24	22
10670-12-10-SM	16	5/8	-10	15.9	1-1/16x12	79	39	27	32
10670-12-12-SM	20	3/4	-12	19.1	1-1/16x12	80	41	27	32
10670-14-12-SM	20	3/4	-12	19.1	1-3/16x12	81	42	32	36
10670-16-12-SM	20	3/4	-12	19.1	1-5/16x12	84	45	32	41
10670-12-16-SM	25	1	-16	25.4	1-1/16x12	89	44	36	32
10670-16-16-SM	25	1	-16	25.4	1-5/16x12	92	47	36	41
10670-20-16-SM	25	1	-16	25.4	1-5/8x12	98	52	41	50

\* These fittings contain a dual seat that accepts both JIC (37°) and SAE (45°) male configurations. The other sizes accept the JIC (37°) male configurations only.

Approved fitting series for hose types:

Also available in stainless steel. Details can be found in CAT 4400.1/UK

SM: Metric Hexagon

70 371LT 372 372RH 372TC 701 F42-8

### 37 Female JIC 37° – Swivel 45° Elbow

ISO 12151-5-SWE 45° – DKJ 45°

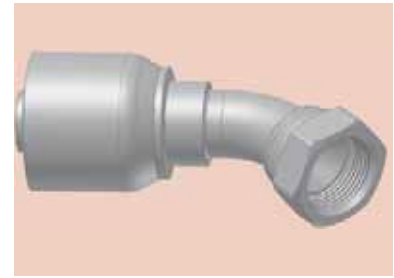
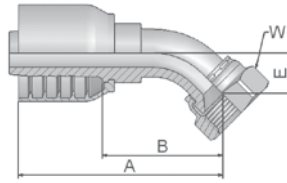

XXXXX-XX-XX Part Number 70	Hose I.D.				Thread UNF	A mm	B mm	E mm	W mm
	DN	Inch	Size	mm					
13770-6-6-SM	10	3/8	-6	9.5	9/16x18	61	31	10	19
13770-8-6-SM*	10	3/8	-6	9.5	3/4x16	70	41	14	22
13770-8-8-SM*	12	1/2	-8	12.7	3/4x16	73	38	14	22
13770-10-8-SM*	12	1/2	-8	12.7	7/8x14	78	43	17	27
13770-8-10-SM*	16	5/8	-10	15.9	3/4x16	78	39	15	22
13770-10-10-SM*	16	5/8	-10	15.9	7/8x14	83	44	17	27
13770-12-10-SM	16	5/8	-10	15.9	1-1/16x12	85	48	21	32
13770-12-12-SM	20	3/4	-12	19.1	1-1/16x12	91	52	20	32
13770-16-12-SM	20	3/4	-12	19.1	1-5/16x12	95	56	24	41
13770-16-16-SM	25	1	-16	25.4	1-5/16x12	111	66	24	41
13770-20-16-SM	25	1	-16	25.4	1-5/8x12	113	67	26	50

\* These fittings contain a dual seat that accepts both JIC (37°) and SAE (45°) male configurations. The other sizes accept the JIC (37°) male configurations only.

### 39/3W Female JIC 37° SAE 45° – Dual Flare Swivel Female 90° Elbow

ISO 12151-5-SWES – DKJ 90°

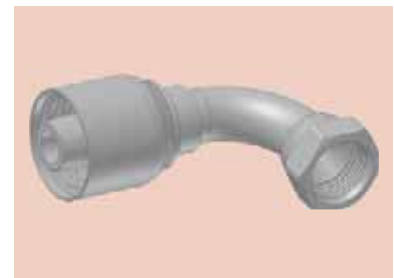
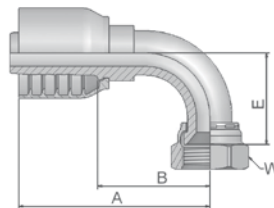

XXXXX-XX-XX Part Number 70	Hose I.D.				Thread UNF	A mm	B mm	E mm	W mm
	DN	Inch	Size	mm					
13970-6-6-SM	10	3/8	-6	9.5	9/16x18	57	28	23	19
13W70-8-6-SM	10	3/8	-6	9.5	3/4x16	64	35	28	22
13970-6-8-SM	12	1/2	-8	12.7	9/16x18	64	29	22	19
13970-8-8-SM*	12	1/2	-8	12.7	3/4x16	68	33	28	22
13970-10-8-SM*	12	1/2	-8	12.7	7/8x14	74	39	32	27
13970-8-10-SM*	16	5/8	-10	15.9	3/4x16	74	34	28	22
13970-10-10-SM*	16	5/8	-10	15.9	7/8x14	80	41	33	27
13970-12-10-SM	16	5/8	-10	15.9	1-1/16x12	88	48	47	32
13970-12-12-SM	20	3/4	-12	19.1	1-1/16x12	89	50	48	32
13970-16-12-SM	20	3/4	-12	19.1	1-5/16x12	89	50	51	41
13970-12-16-SM	25	1	-16	25.4	1-1/16x12	99	54	46	32
13970-16-16-SM	25	1	-16	25.4	1-5/16x12	109	64	56	41
13970-20-16-SM	25	1	-16	25.4	1-5/8x12	109	64	62	50

\* These fittings contain a dual seat that accepts both JIC (37°) and SAE (45°) male configurations. The other sizes accept the JIC (37°) male configurations only.

Approved fitting series for hose types:

Also available in stainless steel. Details can be found in CAT 4400.1/UK

SM: Metric Hexagon

70 371LT 372 372RH 372TC 701 F42-8

# 15 SAE Code 61 – Flange Head Straight

ISO 12151-3-S-L – SFL  
3000 psi

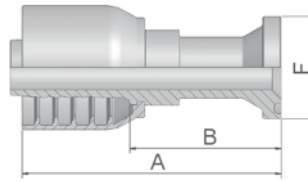

XXXXX-XX-XX Part Number 70	Hose I.D.				Flange	A mm	B mm	F mm
	DN	Inch	Size	mm				
11570-8-8	12	1/2	-8	12.7	1/2	89	54	30
11570-10-10	16	5/8	-10	15.9	5/8	116	79	34
11570-12-10	16	5/8	-10	15.9	3/4	69	30	38
11570-12-12	20	3/4	-12	19.1	3/4	98	59	38
11570-16-12	20	3/4	-12	19.1	1	70	31	45
11570-20-12	20	3/4	-12	19.1	1-1/4	75	36	51
11570-12-16	25	1	-16	25.4	3/4	111	66	38
11570-16-16	25	1	-16	25.4	1	108	63	45
11570-20-16	25	1	-16	25.4	1-1/4	83	36	51

Find SAE flange halves in section Eb.  
Fittings with standard O-ring seals can be used for temperatures from -30 °C up to +105 °C.  
Find O-rings in section E. Special O-rings are available on request.

# 17 SAE Code 61 – Flange Head 45° Elbow

ISO 12151-3 – E45 – L – SFL 45°  
3000 psi

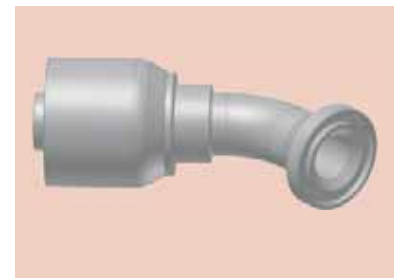
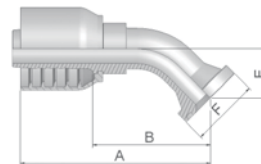

XXXXX-XX-XX Part Number 70	Hose I.D.				Flange	A mm	B mm	E mm	F mm
	DN	Inch	Size	mm					
11770-8-8	12	1/2	-8	12.7	1/2	79	44	20	30
11770-10-10	16	5/8	-10	15.9	5/8	104	67	24	34
11770-12-10	16	5/8	-10	15.9	3/4	96	57	26	38
11770-12-12	20	3/4	-12	19.1	3/4	97	58	26	38
11770-16-12	20	3/4	-12	19.1	1	98	58	26	45
11770-16-16	25	1	-16	25.4	1	121	74	32	45
11770-20-16	25	1	-16	25.4	1-1/4	121	76	32	51

Find SAE flange halves in section Eb.  
Fittings with standard O-ring seals can be used for temperatures from -30 °C up to +105 °C.  
Find O-rings in section E. Special O-rings are available on request.

Approved fitting series for hose types:

Also available in stainless steel. Details can be found in CAT 4400.1/UK

70 371LT 372 372RH 372TC 701 F42-8

## 19 SAE Code 61 – Flange Head 90° Elbow

ISO 12151-3 – E– L – SFL 90°  
3000 psi

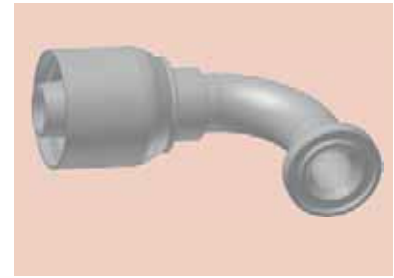
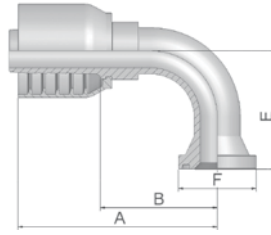

XXXXX-XX-XX Part Number 70	Hose I.D.				Flange	A mm	B mm	E mm	F mm
	DN	Inch	Size	mm					
11970-8-8	12	1/2	-8	12.7	1/2	75	40	41	30
11970-12-8	12	1/2	-8	12.7	3/4	77	42	42	38
11970-10-10	16	5/8	-10	15.9	5/8	92	55	55	34
11970-12-12	20	3/4	-12	19.1	3/4	89	50	58	38
11970-16-12	20	3/4	-12	19.1	1	90	50	58	45
11970-16-16	25	1	-16	25.4	1	105	55	61	45
11970-20-16	25	1	-16	25.4	1-1/4	113	68	70	51

Find SAE flange halves in section Eb.

Fittings with standard O-ring seals can be used for temperatures from -30 °C up to +105 °C.

Find O-rings in section E. Special O-rings are available on request.

## 6A SAE Code 62 Flange Straight

ISO 12151-3-S-S – SFS  
6000 psi

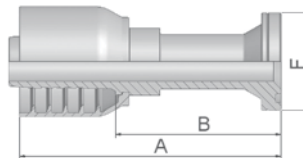

XXXXX-XX-XX Part Number 70	Hose I.D.				Flange	A mm	B mm	F mm
	DN	Inch	Size	mm				
16A70-8-8	12	1/2	-8	12.7	1/2	89	54	32
16A70-12-8	12	1/2	-8	12.7	3/4	74	34	41
16A70-8-10	16	5/8	-10	15.9	1/2	107	68	32
16A70-12-10	16	5/8	-10	15.9	3/4	72	35	41
16A70-8-12	20	3/4	-12	19.1	1/2	107	67	32
16A70-12-12	20	3/4	-12	19.1	3/4	105	66	41
16A70-16-12	20	3/4	-12	19.1	1	79	39	48
16A70-12-16	25	1	-16	25.4	3/4	127	82	41
16A70-16-16	25	1	-16	25.4	1	127	82	48
16A70-20-16	25	1	-16	25.4	1-1/4	99	47	54

Find SAE flange halves in section Eb.

Fittings with standard O-ring seals can be used for temperatures from -30 °C up to +105 °C.

Find O-rings in section E. Special O-rings are available on request.

Approved **fitting series** for hose types:

Also available in stainless steel. Details can be found in CAT 4400.1/UK

70 371LT 372 372RH 372TC 701 F42-8

## 6F SAE Code 62 Flange 45° Elbow – Heavy Series

ISO 12151-3 – E45-S – SFS 45°  
6000 psi

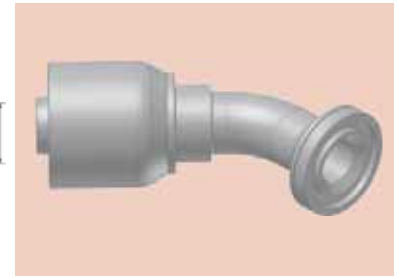
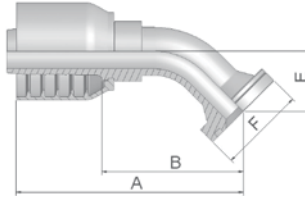

XXXXX-XX-XX Part Number 70	Hose I.D.				Flange	A mm	B mm	E mm	F mm
	DN	Inch	Size	mm					
16F70-8-8	12	1/2	-8	12.7	1/2	81	46	19	31.75
16F70-12-8	12	1/2	-8	12.7	3/4	90	55	26	41
16F70-8-10	16	5/8	-10	15.9	1/2	92	53	26	32
16F70-12-10	16	5/8	-10	15.9	3/4	92	55	26	41
16F70-8-12	20	3/4	-12	19.1	1/2	94	54	26	32
16F70-12-12	20	3/4	-12	19.1	3/4	105	66	26	41
16F70-16-12	20	3/4	-12	19.1	1	101	62	26	48
16F70-12-16	25	1	-16	25.4	3/4	118	73	27	41
16F70-16-16	25	1	-16	25.4	1	119	74	32	48
16F70-20-16	25	1	-16	25.4	1-1/4	120	73	32	54

Find SAE flange halves in section Eb.

Fittings with standard O-ring seals can be used for temperatures from -30 °C up to +105 °C.

Find O-rings in section E. Special O-rings are available on request.

## 6N SAE Code 62 Flange 90° Elbow

ISO 12151-3 – E-S – SFS 90°  
6000 psi

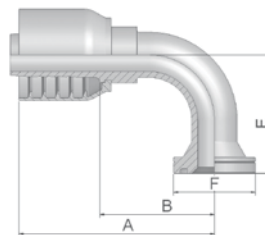

XXXXX-XX-XX Part Number 70	Hose I.D.				Flange	A mm	B mm	E mm	F mm
	DN	Inch	Size	mm					
16N70-8-8	12	1/2	-8	12.7	1/2	74	39	41	32
16N70-12-8	12	1/2	-8	12.7	1/2	79	44	45	41
16N70-8-10	16	5/8	-10	15.9	1/2	95	56	54	32
16N70-12-10	16	5/8	-10	15.9	3/4	94	55	54	41
16N70-16-10	16	5/8	-10	15.9	1	86	46	54	48
16N70-8-12	20	3/4	-12	19.1	1/2	81	42	54	32
16N70-12-12	20	3/4	-12	19.1	3/4	98	59	54	41
16N70-16-12	20	3/4	-12	19.1	1	92	53	58	48
16N70-12-16	25	1	-16	25.4	3/4	113	66	57	41
16N70-16-16	25	1	-16	25.4	1	111	64	70	48

Find SAE flange halves in section Eb.

Fittings with standard O-ring seals can be used for temperatures from -30 °C up to +105 °C.

Find O-rings in section E. Special O-rings are available on request.

Approved fitting series for hose types:

Also available in stainless steel. Details can be found in CAT 4400.1/UK

70 371LT 372 372RH 372TC 701 F42-8

# JC Female ORFS Swivel – Straight Short

ISO 12151-1 – SWSA  
SAE J516 – ORFS

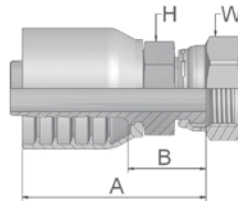

XXXXX-XX-XX Part Number 70	Hose I.D.				Thread UNF	A mm	B mm	H mm	W mm
	DN	Inch	Size	mm					
1JC70-6-6-SM	10	3/8	-6	9.5	11/16x16	49	20	19	22
1JC70-8-6-SM	10	3/8	-6	9.5	13/16x16	51	22	19	24
1JC70-8-8-SM	12	1/2	-8	12.7	13/16x16	56	24	22	24
1JC70-10-8-SM	12	1/2	-8	12.7	1x14	59	24	24	30
1JC70-12-8-SM	12	1/2	-8	12.7	1-3/16x12	63	28	32	36
1JC70-8-10-SM	16	5/8	-10	15.9	13/16x16	59	22	22	24
1JC70-10-10-SM	16	5/8	-10	15.9	1x14	64	24	24	30
1JC70-12-10-SM	16	5/8	-10	15.9	1-3/16x12	68	29	32	36
1JC70-8-12-SM	20	3/4	-12	19.1	13/16x16	61	22	27	24
1JC70-12-12-SM	20	3/4	-12	19.1	1-3/16x12	68	29	32	36
1JC70-16-12-SM	20	3/4	-12	19.1	1-7/16x12	72	33	36	41
1JC70-12-16-SM	25	1	-16	25.4	13/16x12	76	31	36	36
1JC70-16-16-SM	25	1	-16	25.4	1-7/16x12	80	35	36	41
1JC70-20-16-SM	25	1	-16	25.4	1-11/16x12	79	34	41	50

# JS ORFS Swivel Female (Long)

ISO 12151-1-SWSB  
SAE J516 – ORFS

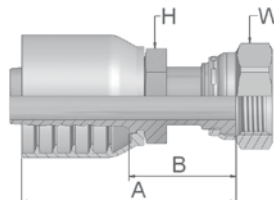

XXXXX-XX-XX Part Number 70	Hose I.D.				Thread UNF	A mm	B mm	H mm	W mm
	DN	Inch	Size	mm					
1JS70-6-6-SM	10	3/8	-6	9.5	11/16x16	58	29	17	22
1JS70-8-6-SM	10	3/8	-6	9.5	13/16x16	64	35	19	24
1JS70-8-8-SM	12	1/2	-8	12.7	13/16x16	67	33	22	24
1JS70-10-8-SM	12	1/2	-8	12.7	1x14	73.5	38.5	24	30
1JS70-10-10-SM	16	5/8	-10	15.9	1x14	79	39	24	30
1JS70-12-12-SM	20	3/4	-12	19.1	1-3/16x12	84	45	30	36
1JS70-16-12-SM	20	3/4	-12	19.1	1-7/16x12	86	47	36	41
1JS70-16-16-SM	25	1	-16	25.4	1-7/16x12	92	51	36	41
1JS70-20-16-SM	25	1	-16	25.4	1-11/16x12	94	47	41	50

Approved fitting series for hose types:

Also available in stainless steel. Details can be found in CAT 4400.1/UK

SM: Metric Hexagon

70 371LT 372 372RH 372TC 701 F42-8



## J7 Female ORFS – Swivel 45° Elbow

ISO 12151-1 – SWE 45°  
SAE J516 – ORFS 45°

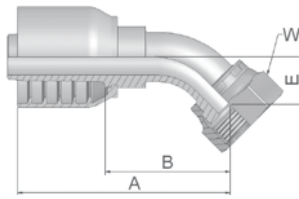

XXXXX-XX-XX Part Number 70	Hose I.D.				Thread UNF	A mm	B mm	E mm	W mm
	DN	Inch	Size	mm					
1J770-6-6-SM	10	3/8	-6	9.5	11/16x16	62	33	11	22
1J770-8-6-SM	10	3/8	-6	9.5	13/16x16	65	35	15	24
1J770-6-8-SM	12	1/2	-8	12.7	11/16x16	68	33	11	22
1J770-8-8-SM	12	1/2	-8	12.7	13/16x16	72	37	15	24
1J770-10-8-SM	12	1/2	-8	12.7	1x14	81	46	17	30
1J770-10-10-SM	16	5/8	-10	15.9	1x14	83	44	16	30
1J770-12-10-SM	16	5/8	-10	15.9	1-3/16x12	90	53	21	36
1J770-12-12-SM	20	3/4	-12	19.1	1-3/16x12	92	53	21	36
1J770-16-12-SM	20	3/4	-12	19.1	1-7/16x12	95	56	24	41
1J770-16-16-SM	25	1	-16	25.4	1-7/16x12	113	66	24	41

## J9 Female ORFS – Swivel 90° Elbow – Short Drop

ISO 12151-1 – SWES  
SAE J516 – ORFS 90°

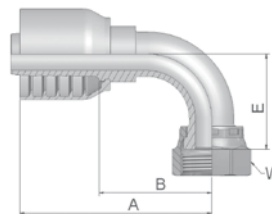

XXXXX-XX-XX Part Number 70	Hose I.D.				Thread UNF	A mm	B mm	E mm	W mm
	DN	Inch	Size	mm					
1J970-6-6-SM	10	3/8	-6	9.5	11/16x16	58	29	23	22
1J970-8-6-SM	10	3/8	-6	9.5	13/16x16	58	29	29	24
1J970-8-8-SM	12	1/2	-8	12.7	13/16x16	70	35	29	24
1J970-10-8-SM	12	1/2	-8	12.7	1x14	73	38	32	30
1J970-12-8-SM	12	1/2	-8	12.7	1-3/16x12	76	41	48	36
1J970-10-10-SM	16	5/8	-10	15.9	1x14	78	39	33	30
1J970-12-10-SM	16	5/8	-10	15.9	1-3/16x12	86	50	48	36
1J970-12-12-SM	20	3/4	-12	19.1	1-3/16x12	89	49	48	36
1J970-16-12-SM	20	3/4	-12	19.1	1-7/16x12	89	49	56	41
1J970-16-16-SM	25	1	-16	25.4	1-7/16x12	111	64	56	41
1J970-20-16-SM	25	1	-16	25.4	1-11/16x12	111	64	64	50

Approved fitting series for hose types:

Also available in stainless steel. Details can be found in CAT 4400.1/UK

SM: Metric Hexagon

70 371LT 372 372RH 372TC 701 F42-8

# J1 Female ORFS – Swivel 90° Elbow – Long Drop

ISO 12151-1 – SWEL  
SAE J 516 – ORFS 90° L

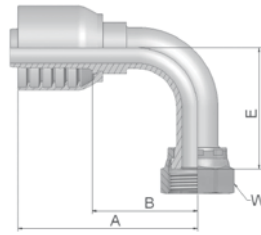

XXXXX-XX-XX Part Number 70	Hose I.D.				Thread UNF	A mm	B mm	E mm	W mm Inch
	DN	Inch	Size	mm					
1J170-8-8-SM	12	1/2	-8	12.7	13/16x16	71	36	64	24
1J170-10-8-SM	12	1/2	-8	12.7	1x14	73	38	70	30
1J170-10-10-SM	16	5/8	-10	15.9	1x14	78	39	70	30
1J170-12-10-SM	16	5/8	-10	15.9	1-3/16x12	76	40	96	36
1J170-12-12-SM	20	3/4	-12	19.1	1-3/16x12	89	49	96	36
1J170-16-16-SM	25	1	-16	25.4	1-7/16x12	111	64	114	41

# JM ORFS Male

ISO 12151-1-S – SAE J516

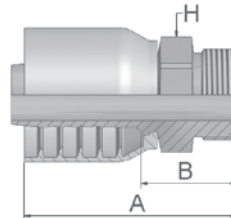

XXXXX-XX-XX Part Number 70	Hose I.D.				Thread UNF	A mm	B mm	H mm
	DN	Inch	Size	mm				
1JM70-6-6-SM	10	3/8	-6	9.5	11/16x16	53	24	19
1JM70-8-6-SM	10	3/8	-6	9.5	13/16x16	56	27	22
1JM70-8-8-SM	12	1/2	-8	12.7	13/16x16	62	27	22
1JM70-10-8-SM	12	1/2	-8	12.7	1x14	66	32	27
1JM70-10-10-SM	16	5/8	-10	15.9	1x14	68	32	27
1JM70-12-10-SM	16	5/8	-10	15.9	1-3/16x12	71	34	32
1JM70-12-12-SM	20	3/4	-12	19.1	1-3/16x12	74	34	32
1JM70-16-12-SM	20	3/4	-12	19.1	1-7/16x12	74	35	41
1JM70-16-16-SM	25	1	-16	25.4	1-7/16x12	84	39	41
1JM70-20-16-SM	25	1	-16	25.4	1-11/16x12	82	37	46

JM fittings are supplied without O-ring.  
Find O-rings in section E. Special O-rings are available on request.

Approved fitting series for hose types:

Also available in stainless steel. Details can be found in CAT 4400.1/UK

SM: Metric Hexagon

70 371LT 372 372RH 372TC 701 F42-8

# MU Female Metric – Swivel Straight (30° Flare)

JIS B8363 – MU

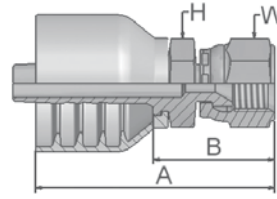

XXXXX-XX-XX Part Number 70	Hose I.D.				Thread metric	A mm	B mm	H mm	W mm
	DN	Inch	Size	mm					
1MU70-6-6	10	3/8	-6	9.5	M18x1.5	62	33	24	24
1MU70-8-8	12	1/2	-8	12.7	M22x1.5	72	37	27	27
1MU70-12-12	20	3/4	-12	19.1	M27x2	81	41	36	36

Approved **fitting series** for hose types:

Also available in stainless steel. Details can be found in CAT 4400.1/UK

70 371LT 372 372RH 372TC 701 F42-8

## FG Male French Gas Series Rigid – Straight (24° Cone)

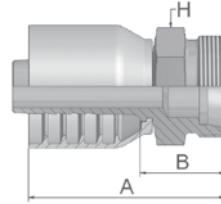

XXXXX-XX-XX Part Number 70	Hose I.D.				Thread metric	Tube O.D. mm	A mm	B mm	H mm
	DN	Inch	Size	mm					
1FG70-13-6	10	3/8	-6	9.5	M20x1.5	13.25	46	24	22
1FG70-17-8	12	1/2	-8	12.7	M24x1.5	16.75	62	27	24
1FG70-21-10	16	5/8	-10	15.9	M30x1.5	21.25	70	30	30
1FG70-27-12	20	3/4	-12	19.1	M36x1.5	26.75	70	30	36
1FG70-33-16	25	1	-16	25.4	M45x1.5	33.50	82	36	46

## F4 Female French Gas Series Swivel – Straight (Ball Nose)

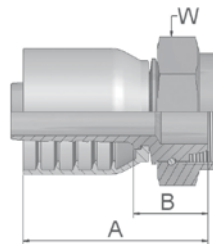

XXXXX-XX-XX Part Number 70	Hose I.D.				Thread metric	Tube O.D. mm	A mm	B mm	W mm
	DN	Inch	Size	mm					
1F470-13-6	10	3/8	-6	9.5	M20x1.5	13	52	22	24
1F470-17-8	12	1/2	-8	12.7	M24x1.5	17	60	25	30
1F470-21-10	16	5/8	-10	15.9	M30x1.5	21	62	25	36
1F470-27-12	20	3/4	-12	19.1	M36x1.5	27	70	31	46
1F470-33-16°	25	1	-16	25.4	M45x1.5	33	77	32	55

°Assembly only with Parkrimp 2 machine

Approved **fitting series** for hose types:

Also available in stainless steel. Details can be found in CAT 4400.1/UK

70 371LT 372 372RH 372TC 701 F42-8

## XU Female Metric – Swivel Straight (30° Flare)

JIS B8363

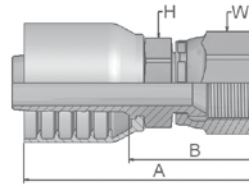

XXXXX-XX-XX Part Number 70	Hose I.D.				Thread metric	A mm	B mm	H mm	W mm
	DN	Inch	Size	mm					
1XU70-10-10	16	5/8	-10	15.9	M24x1.5	67	28	30	32
1XU70-12-12	20	3/4	-12	19.1	M30x1.5	68	28	32	36
1XU70-16-16	25	1	-16	25.4	M33x1.5	82	35	36	41

## XY Female Metric – Swivel 90° Elbow (30° Flare)

JIS B8363

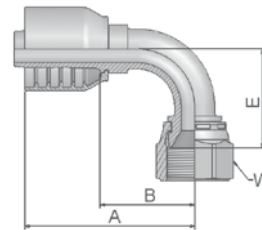









XXXXX-XX-XX Part Number 70	Hose I.D.				Thread metric	A mm	B mm	E mm	W mm
	DN	Inch	Size	mm					
1XY70-10-10	16	5/8	-10	15.9	M24x1.5	80	41	41	32
1XY70-12-12	20	3/4	-12	19.1	M24x1.5	89	49	52	36

Approved **fitting series** for hose types:





Also available in stainless steel. Details can be found in CAT 4400.1/UK

70 371LT 372 372RH 372TC 701 F42-8





## DIN – Metric

Page Dc-1 – Dc-4			
<p><b>CA</b> Dc-1</p>  <p>Female Metric 24° Light Series with O-Ring Swivel – Straight ISO 12151-2-SWS-L – DKOL</p>	<p><b>CE</b> Dc-1</p>  <p>Female Metric 24° Light Series with O-Ring Swivel – 45° Elbow ISO 12151-2-SWE 45°-L – DKOL 45°</p>	<p><b>CF</b> Dc-2</p>  <p>Female Metric 24° Light Series with O-Ring Swivel – 90° Elbow ISO 12151-2-SWE-L – DKOL 90°</p>	<p><b>D0</b> Dc-2</p>  <p>Male Metric 24° Light Series – Rigid Straight ISO 12151-2-S-L – CEL</p>
<p><b>C9</b> Dc-3</p>  <p>Female Metric 24° – Swivel Heavy Series with O-Ring Straight ISO 12151-2-SWS-S – DKOS</p>	<p><b>OC</b> Dc-3</p>  <p>Female Metric 24° – Swivel Heavy Series with O-Ring 45° Elbow ISO 12151-2 – SWE 45°-S – DKOS 45°</p>	<p><b>1C</b> Dc-4</p>  <p>Female Metric 24° – Swivel Heavy Series with O-Ring 90° Elbow ISO 12151-2-SWE-S – DKOS 90°</p>	<p><b>D2</b> Dc-4</p>  <p>Male Metric 24° – Rigid Heavy Series – Straight ISO 12151-2-S-S – CES</p>





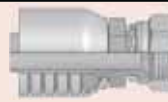

## BSP

Page Dc-5 – Dc-6			
<p><b>92</b> Dc-5</p>  <p>Female BSP Parallel Pipe Swivel – Straight (60° Cone) BS5200-A – DKR</p>	<p><b>B1</b> Dc-5</p>  <p>Female BSP Parallel Pipe Swivel 45° Elbow (60° Cone) BS 5200-D – DKR 45°</p>	<p><b>B2</b> Dc-6</p>  <p>Female BSP Parallel Pipe Swivel 90° Elbow (60° Cone) BS 5200-B – DKR 90°</p>	<p><b>D9</b> Dc-6</p>  <p>Male BSP Parallel Pipe Rigid – Straight (60° Cone) BS5200 – AGR</p>





## SAE

Page Dc-7 – Dc-9			
<p><b>01</b> Dc-7</p>  <p>Male NPTF Pipe Rigid – Straight SAE J476A / J516 – AGN</p>	<p><b>03</b> Dc-7</p>  <p>Male JIC 37° – Rigid Straight ISO12151-5-S – AGJ</p>	<p><b>06</b> Dc-8</p>  <p>Female JIC 37° – Swivel Straight ISO12151-5-SWS – DKJ</p>	<p><b>37</b> Dc-9</p>  <p>Female JIC 37° – Swivel 45° Elbow ISO 12151-5-SWE 45° – DKJ 45°</p>
<p><b>39</b> Dc-9</p>  <p>Female JIC 37° – Swivel 90° Elbow ISO 12151-5-SWES – DKJ 90°</p>			

## Flange

Page Dc-10 – Dc-13			
<p><b>15</b> Dc-10</p>  <p>SAE Code 61 – Flange Head Straight ISO 12151-3-S-L – SFL 3000 psi</p>	<p><b>16</b> Dc-10</p>  <p>SAE Code 61 – Flange Head 22.5° Elbow ISO 12151-3-E22ML – SFL 22.5° 3000 psi</p>	<p><b>17</b> Dc-11</p>  <p>SAE Code 61 – Flange Head 45° Elbow ISO 12151-3 – E45 – L – SFL 45° 3000 psi</p>	<p><b>19</b> Dc-11</p>  <p>SAE Code 61 – Flange Head 90° Elbow ISO 12151-3 – E – L – SFL 90° 3000 psi</p>
<p><b>6A</b> Dc-12</p>  <p>SAE Code 62 Flange Straight ISO 12151-3-S-S – SFS 6000 psi</p>	<p><b>6F</b> Dc-12</p>  <p>SAE Code 62 Flange 45° Elbow – Heavy Series ISO 12151-3 – E45-S – SFS 45° 6000 psi</p>	<p><b>6N</b> Dc-13</p>  <p>SAE Code 62 Flange 90° Elbow ISO 12151-3 – E-S – SFS 90° 6000 psi</p>	

## ORFS

Page Dc-14 – Dc-15			
<p><b>JC</b> Dc-14</p>  <p>Female ORFS Swivel – Straight Short ISO 12151-1 – SWSA SAE J516 – ORFS</p>	<p><b>JS</b> Dc-14</p>  <p>ORFS Swivel Female (Long) ISO 12151-1-SWSB SAE J516 – ORFS</p>	<p><b>J7</b> Dc-15</p>  <p>Female ORFS – Swivel 45° Elbow ISO 12151-1 – SWE 45° SAE J516 – ORFS 45°</p>	<p><b>J9</b> Dc-15</p>  <p>Female ORFS – Swivel 90° Elbow – Short Drop ISO 12151-1 – SWES SAE J516 – ORFS 90°</p>

## Others

Page Dc-16	
<p><b>XU</b> Dc-16</p>  <p>Female Metric – Swivel Straight (30° Flare) JIS B8363</p>	





## CA Female Metric 24° Light Series with O-Ring Swivel – Straight

ISO 12151-2-SWS-L – DKOL

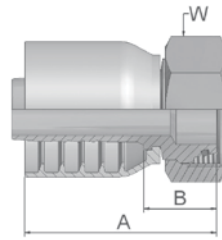

XXXXX-XX-XX Part Number 71	Hose I.D.				Thread metric	Tube O.D. mm	A mm	B mm	W mm
	DN	Inch	Size	mm					
1CA71-12-6	10	3/8	-6	9.5	M18x1.5	12	53	24	22
1CA71-15-8	12	1/2	-8	12.7	M22x1.5	15	62	27	27
1CA71-18-10	16	5/8	-10	15.9	M26x1.5	18	62	26	32
1CA71-22-10	16	5/8	-10	15.9	M30x2	22	64	24	36
1CA71-22-12	20	3/4	-12	19.1	M30x2	22	63	24	36
1CA71-35-16	25	1	-16	25.4	M45x2	35	76	31	50
1CA71-35-20	32	1-1/4	-20	31.8	M45x2	35	82	35	50
1CA71-42-24	40	1-1/2	-24	38.1	M52x2	42	99	39	60

Fittings with standard O-ring seals can be used for temperatures from -30 °C up to +105 °C.  
Find O-rings in section E. Special O-rings are available on request.  
Attention: Hose assembly pressure is reduced; see page Ab-8

## CE Female Metric 24° Light Series with O-Ring Swivel – 45° Elbow

ISO 12151-2-SWE 45°-L – DKOL 45°

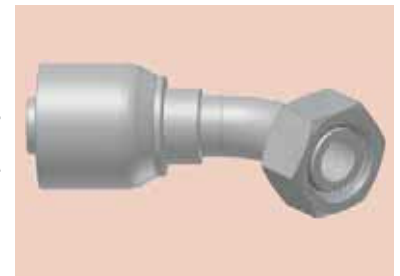
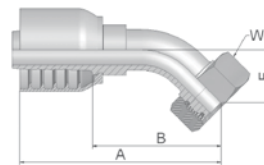

XXXXX-XX-XX Part Number 71	Hose I.D.				Thread metric	Tube O.D. mm	A mm	B mm	E mm	W mm
	DN	Inch	Size	mm						
1CE71-35-20	32	1-1/4	-20	31.8	M45x2	35	141	94	38	50
1CE71-42-24	40	1-1/2	-24	38.1	M52x2	42	178	118	49	60

Fittings with standard O-ring seals can be used for temperatures from -30 °C up to +105 °C.  
Find O-rings in section E. Special O-rings are available on request.  
Attention: Hose assembly pressure is reduced; see page Ab-8

Approved **fitting series** for hose types:

71 774 721TC 772LT

**CF** **Female Metric 24°  
Light Series with O-Ring  
Swivel – 90° Elbow**

ISO 12151-2-SWE-L – DKOL 90°

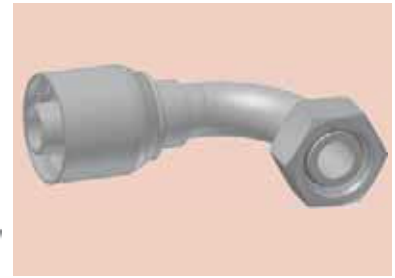
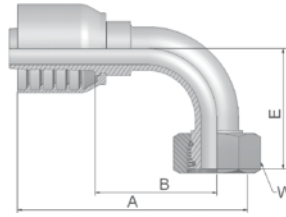

XXXXX-XX-XX Part Number 71	Hose I.D.				Thread metric	Tube O.D. mm	A mm	B mm	E mm	W mm
	DN	Inch	Size	mm						
1CF71-12-6	10	3/8	-6	9.5	M18x1.5	12	67	38	37	22
1CF71-15-8	12	1/2	-8	12.7	M22x1.5	15	74	39	45	27
1CF71-18-10	16	5/8	-10	15.9	M26x1.5	18	79	42	49	32
1CF71-22-12	20	3/4	-12	19.1	M30x2	22	89	49	55	36
1CF71-28-16	25	1	-16	25.4	M36x2	28	113	68	73	41
1CF71-35-20	32	1-1/4	-20	31.8	M45x2	35	130	83	79	50
1CF71-42-24	40	1-1/2	-24	38.1	M52x2	42	161	101	101	60

Fittings with standard O-ring seals can be used for temperatures from -30 °C up to +105 °C.  
Find O-rings in section E. Special O-rings are available on request.  
Attention: Hose assembly pressure is reduced; see page Ab-8

**DO** **Male Metric 24°  
Light Series – Rigid  
Straight**

ISO 12151-2-S-L – CEL

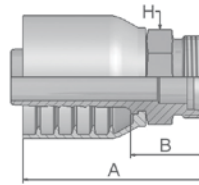

XXXXX-XX-XX Part Number 71	Hose I.D.				Thread metric	Tube O.D. mm	A mm	B mm	H mm
	DN	Inch	Size	mm					
1D071-42-24	40	1-1/2	-24	38.1	M52x2	42	99	39	55

Attention: Hose assembly pressure is reduced; see page Ab-8

Approved **fitting series** for hose types:

71 774 721TC 772LT

## C9 Female Metric 24° – Swivel Heavy Series with O-Ring Straight

ISO 12151-2-SWS-S – DKOS

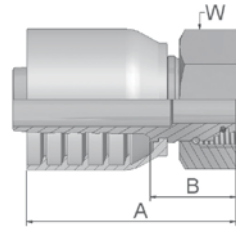

XXXXX-XX-XX Part Number 71	Hose I.D.				Thread metric	Tube O.D. mm	A mm	B mm	W mm
	DN	Inch	Size	mm					
1C971-16-8	12	1/2	-8	12.7	M24x1.5	16	59	24	30
1C971-20-10	16	5/8	-10	15.9	M30x2	20	66	27	36
1C971-25-12	20	3/4	-12	19.1	M36x2	25	68	28	46
1C971-25-16	25	1	-16	25.4	M36x2	25	78	33	46
1C971-30-16	25	1	-16	25.4	M42x2	30	78	33	50
1C971-38-20°	32	1-1/4	-20	31.8	M52x2	38	80	33	60
1C971-38-24	40	1-1/2	-24	38.1	M52x2	38	99	39	60

Fittings with standard O-ring seals can be used for temperatures from -30 °C up to +105 °C.  
Find O-rings in section E. Special O-rings are available on request.

\*Assembly only with Parkrimp 2 machine

## OC Female Metric 24° – Swivel Heavy Series with O-Ring 45° Elbow

ISO 12151-2 – SWE 45°-S – DKOS 45°

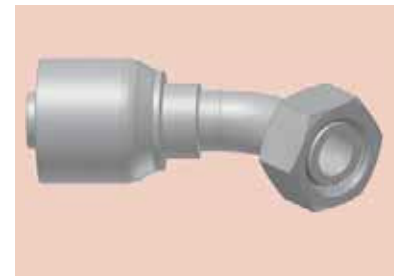
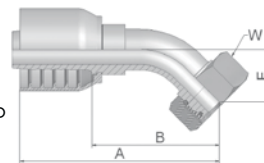

XXXXX-XX-XX Part Number 71	Hose I.D.				Thread metric	Tube O.D. mm	A mm	B mm	E mm	W mm
	DN	Inch	Size	mm						
10C71-16-8	12	1/2	-8	12.7	M24x1.5	16	83	48	24	30
10C71-20-10	16	5/8	-10	15.9	M30x2	20	91	52	25	36
10C71-25-12	20	3/4	-12	19.1	M36x2	25	101	61	30	46
10C71-30-16	25	1	-16	25.4	M42x2	30	126	79	36	50
10C71-38-20°	32	1-1/4	-20	31.8	M52x2	38	140	93	37	60
10C71-38-24	40	1-1/2	-24	38.1	M52x2	38	178	118	49	60

Fittings with standard O-ring seals can be used for temperatures from -30 °C up to +105 °C.  
Find O-rings in section E. Special O-rings are available on request.

\*Assembly only with Parkrimp 2 machine

Approved **fitting series** for hose types:

71 774 721TC 772LT

# 1C Female Metric 24° – Swivel Heavy Series with O-Ring 90° Elbow

ISO 12151-2-SWE-S – DKOS 90°

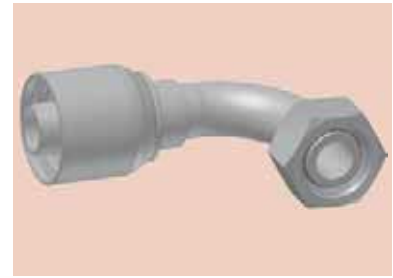
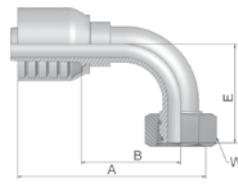

XXXXX-XX-XX Part Number 71	Hose I.D.				Thread metric	Tube O.D. mm	A mm	B mm	E mm	W mm
	DN	Inch	Size	mm						
11C71-12-8	12	1/2	-8	12.7	M20x1.5	12	71	36	44	24
11C71-16-8	12	1/2	-8	12.7	M24x1.5	16	72	37	45	30
11C71-20-10	16	5/8	-10	15.9	M30x2	20	79	40	48	36
11C71-25-12	20	3/4	-12	19.1	M36x2	25	89	49	59	46
11C71-30-16	25	1	-16	25.4	M42x2	30	115	68	76	50
11C71-38-20°	32	1-1/4	-20	31.8	M52x2	38	130	83	78	60

Fittings with standard O-ring seals can be used for temperatures from -30 °C up to +105 °C.

Find O-rings in section E. Special O-rings are available on request.

°Assembly only with Parkrimp 2 machine

# D2 Male Metric 24° – Rigid Heavy Series – Straight

ISO 12151-2-S-S – CES

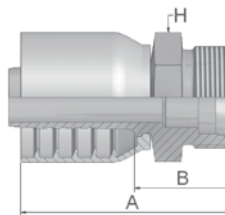

XXXXX-XX-XX Part Number 71	Hose I.D.				Thread metric	Tube O.D. mm	A mm	B mm	H mm
	DN	Inch	Size	mm					
1D271-14-6	10	3/8	-6	9.5	M22x1.5	14	55	25	22
1D271-16-8	12	1/2	-8	12.7	M24x1.5	16	62	28	24
1D271-20-12	20	3/4	-12	19.1	M30x2	20	77	33	30
1D271-25-12	20	3/4	-12	19.1	M36x2	25	74	35	36
1D271-30-16	25	1	-16	25.4	M42x2	30	85	40	46
1D271-38-20	32	1-1/4	-20	31.8	M52x2	38	43	44	55

Approved **fitting series** for hose types:

71 774 721TC 772LT

## 92 Female BSP Parallel Pipe Swivel – Straight (60° Cone)

BS5200-A – DKR

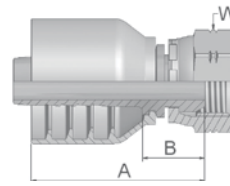

XXXXX-XX-XX Part Number 71	Hose I.D.				Thread BSP	A mm	B mm	W mm
	DN	Inch	Size	mm				
19271-6-6	10	3/8	-6	9.5	3/8x19	49	20	22
19271-8-8	12	1/2	-8	12.7	1/2x14	57	22	27
19271-10-10	16	5/8	-10	15.9	5/8x14	57	21	30
19271-12-12	20	3/4	-12	19.1	3/4x14	61	22	32
19271-16-16	25	1	-16	25.4	1x11	73	26	41
19271-20-20	32	1-1/4	-20	31.8	1-1/4x11	79	32	50
19271-24-24	40	1-1/2	-24	38.1	1-1/2x11	93	33	60
19271-32-32	50	2	-32	50.8	2x11	101	35	70

## B1 Female BSP Parallel Pipe Swivel 45° Elbow (60° Cone)

BS 5200-D – DKR 45°

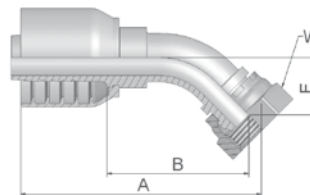

XXXXX-XX-XX Part Number 71	Hose I.D.				Thread BSP	A mm	B mm	E mm	W mm
	DN	Inch	Size	mm					
1B171-10-10	16	5/8	-10	15.9	5/8x14	90	50	24	30
1B171-12-12	20	3/4	-12	19.1	3/4x14	96	57	25	32
1B171-16-16	25	1	-16	25.4	1x11	120	75	31	41
1B171-20-20	32	1-1/4	-20	31.8	1-1/4x11	139	91	35	50

Approved **fitting series** for hose types:

71 774 721TC 772LT

## B2 Female BSP Parallel Pipe Swivel 90° Elbow (60° Cone)

BS 5200-B – DKR 90°

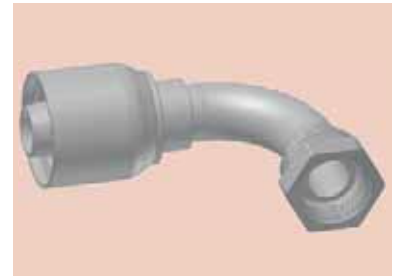
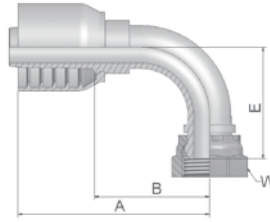

XXXXX-XX-XX Part Number 71	Hose I.D.				Thread BSP	A mm	B mm	E mm	W mm
	DN	Inch	Size	mm					
1B271-6-6	10	3/8	-6	9.5	3/8x19	66	37	33	22
1B271-12-12	20	3/4	-12	19.1	3/4x14	89	50	53	32
1B271-16-16	25	1	-16	25.4	1x11	116	69	69	41
1B271-20-20	32	1-1/4	-20	31.8	1-1/4x11	130	82	80	50
1B271-24-24	40	1-1/2	-24	38.1	1-1/2x11	163	102	103	55
1B271-32-32	50	2	-32	50.8	2x11	197	132	134	70

## D9 Male BSP Parallel Pipe Rigid – Straight (60° Cone)

BS5200 – AGR

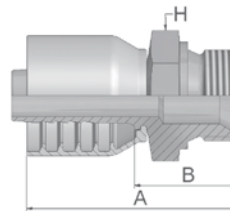

XXXXX-XX-XX Part Number 71	Hose I.D.				Thread BSP	A mm	B mm	H mm
	DN	Inch	Size	mm				
1D971-12-12	20	3/4	-12	19.1	3/4x14	70	30	32
1D971-16-16	25	1	-16	25.4	1x11	85	40	41
1D971-20-20	32	1-1/4	-20	31.8	1-1/4x11	92	45	50
1D971-24-24	40	1-1/2	-24	38.1	1-1/2x11	109	49	55

Approved **fitting series** for hose types:

71 774 721TC 772LT

# 01

## Male NPTF Pipe Rigid – Straight

SAE J476A / J516 – AGN

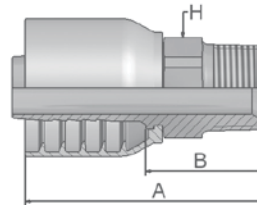

XXXXX-XX-XX Part Number 71	Hose I.D.				Thread NPTF	A mm	B mm	H mm Inch
	DN	Inch	Size	mm				
10171-6-6	10	3/8	-6	9.5	3/8x18	60	31	19
10171-8-6-SM	10	3/8	-6	9.5	1/2x14	61	32	22
10171-8-8	12	1/2	-8	12.7	1/2x14	72	41	7/8
10171-12-10-SM	16	5/8	-10	15.9	3/4x14	71	34	27
10171-12-12-SM	20	3/4	-12	19.1	3/4x14	79	39	27
10171-16-12-SM	20	3/4	-12	19.1	1x11-1/2	79	39	36
10171-16-16	25	1	-16	25.4	1x11-1/2	93	46	1-3/8
10171-20-16	25	1	-16	25.4	1-1/4x11-1/2	89	48	1-11/16
10171-20-20-SM	32	1-1/4	-20	31.8	1-1/4x11-1/2	104	57	46
10171-24-24-SM	40	1-1/2	-24	38.1	1-1/2x11-1/2	112	51	50
10171-32-32	50	2	-32	50.8	2x11-1/2	118	64	2-1/2

# 03

## Male JIC 37° – Rigid Straight

ISO12151-5-S – AGJ

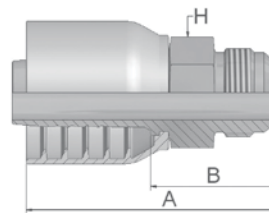

XXXXX-XX-XX Part Number 71	Hose I.D.				Thread UNF	A mm	B mm	H mm
	DN	Inch	Size	mm				
10371-6-6-SM	10	3/8	-6	9.5	9/16x18	60	31	19
10371-8-6-SM	10	3/8	-6	9.5	3/4x16	59	29	19
10371-8-8-SM	12	1/2	-8	12.7	3/4x16	68	37	7/8
10371-10-8-SM	12	1/2	-8	12.7	7/8x14	67	32	24
10371-12-8-SM	12	1/2	-8	12.7	1-1/16x12	71	36	27
10371-12-12-SM	20	3/4	-12	19.1	1-1/16x12	82	42	27
10371-16-12-SM	20	3/4	-12	19.1	1-5/16x12	77	38	36
10371-16-16-SM	25	1	-16	25.4	1-5/16x12	94	47	36
10371-20-16-SM	25	1	-16	25.4	1-5/8x12	88	43	46
10371-20-20-SM	32	1-1/4	-20	31.8	1-5/8x12	101	53	46
10371-24-24-SM	40	1-1/2	-24	38.1	1-7/8x12	110	49	50

Approved fitting series for hose types:

SM: Metric Hexagon

71 774 721TC 772LT

# 06 Female JIC 37° – Swivel Straight

ISO12151-5-SWS – DKJ

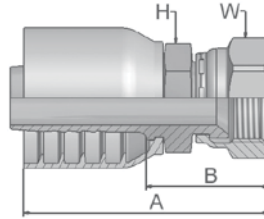

XXXXX-XX-XX Part Number 71	Hose I.D.				Thread UNF	A mm	B mm	H mm Inch	W mm Inch
	DN	Inch	Size	mm					
10671-6-6-SM	10	3/8	-6	9.5	9/16x18	58	29	17	19
10671-8-6-SM	10	3/8	-6	9.5	3/4x16	61	32	19	22
10671-8-8-SM	12	1/2	-8	12.7	3/4x16	67	32	22	22
10671-10-8-SM*	12	1/2	-8	12.7	7/8x14	70	35	22	27
10671-8-10-SM	16	5/8	-10	15.9	3/4x16	73	36	24	22
10671-12-10-SM	16	5/8	-10	15.9	1-1/16x12	78	41	27	32
10671-10-12-SM	20	3/4	-12	19.1	7/8x14	74	35	27	27
10671-12-12-SM	20	3/4	-12	19.1	1-1/16x12	80	41	27	32
10671-14-12-SM	20	3/4	-12	19.1	1-3/16x12	81	42	32	36
10671-16-12-SM	20	3/4	-12	19.1	1-5/16x12	84	45	32	41
10671-12-16-SM	25	1	-16	25.4	1-1/16x12	89	44	36	32
10671-16-16-SM	25	1	-16	25.4	1-5/16x12	92	47	36	41
10671-20-16	25	1	-16	25.4	1-5/8x12	98	53	1-7/8	2
10671-16-20-SM	32	1-1/4	-20	31.8	1-5/16x12	97	50	46	41
10671-20-20	32	1-1/4	-20	31.8	1-5/8x12	100	57	1-7/8	2
10671-24-20	32	1-1/4	-20	31.8	1-7/8x12	104	62	2-1/8	2-1/4
10671-24-24	40	1-1/2	-24	38.1	1-7/8x12	119	64	2-1/8	2-1/4
10671-24-24-SM	40	1-1/2	-24	38.1	1-7/8x12	127	61	50	60

\* These fittings contain a dual seat that accepts both JIC (37°) and SAE (45°) male configurations. The other sizes accept the JIC (37°) male configurations only.

Approved fitting series for hose types:

SM: Metric Hexagon

71 774 721TC 772LT



### 37 Female JIC 37° – Swivel 45° Elbow

ISO 12151-5-SWE 45° – DKJ 45°

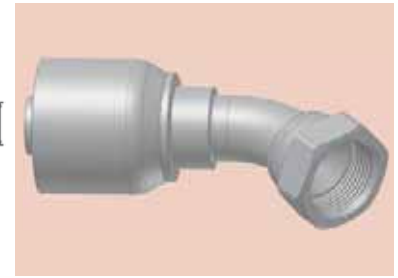
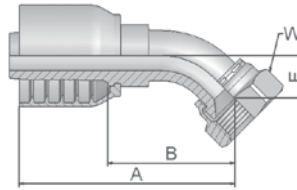

XXXXX-XX-XX Part Number 71	Hose I.D.				Thread UNF	A mm	B mm	E mm	W mm
	DN	Inch	Size	mm					
13771-6-6-SM	10	3/8	-6	9.5	9/16x18	61	31	10	19
13771-8-8-SM*	12	1/2	-8	12.7	3/4x16	73	38	14	22
13771-10-10-SM*	16	5/8	-10	15.9	7/8x14	83	44	17	27
13771-12-12-SM	20	3/4	-12	19.1	1-1/16x12	91	52	20	32
13771-16-16-SM	25	1	-16	25.4	1-5/16x12	111	66	24	41
13771-20-16-SM	25	1	-16	25.4	1-5/8x12	113	67	26	50
13771-20-20-SM	32	1-1/4	-20	31.8	1-5/8x12	134	87	30	50
13771-24-24-SM	40	1-1/2	-24	38.1	1-7/8x12	174	114	46	60

\* These fittings contain a dual seat that accepts both JIC (37°) and SAE (45°) male configurations. The other sizes accept the JIC (37°) male configurations only.

### 39 Female JIC 37° – Swivel 90° Elbow

ISO 12151-5-SWES – DKJ 90°

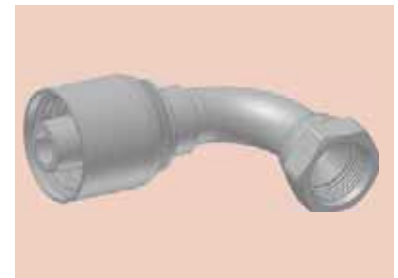
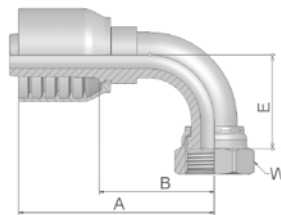

XXXXX-XX-XX Part Number 71	Hose I.D.				Thread UNF	A mm	B mm	E mm	W mm
	DN	Inch	Size	mm					
13971-6-6-SM	10	3/8	-6	9.5	9/16x18	57	28	23	19
13971-8-8-SM*	12	1/2	-8	12.7	3/4x16	68	33	28	22
13971-10-8-SM*	12	1/2	-8	12.7	7/8x14	74	39	32	27
13971-10-10-SM*	16	5/8	-10	15.9	7/8x14	80	41	33	27
13971-12-12-SM	20	3/4	-12	19.1	1-1/16x12	89	50	48	32
13971-16-12-SM	20	3/4	-12	19.1	1-5/16x12	89	50	51	41
13971-16-16-SM	25	1	-16	25.4	1-5/16x12	109	64	55	41
13971-20-16-SM	25	1	-16	25.4	1-5/8x12	109	64	62	50
13971-20-20-SM	32	1-1/4	-20	31.8	1-5/8x12	129	82	70	50
13971-24-20-SM	32	1-1/4	-20	31.8	1-7/8x12	130	82	80	60
13971-24-24-SM	40	1-1/2	-24	38.1	1-7/8x12	161	101	101.5	60

\* These fittings contain a dual seat that accepts both JIC (37°) and SAE (45°) male configurations. The other sizes accept the JIC (37°) male configurations only.

Approved fitting series for hose types:

SM: Metric Hexagon

71 774 721TC 772LT

## 15 SAE Code 61 – Flange Head Straight

ISO 12151-3-S-L – SFL  
3000 psi

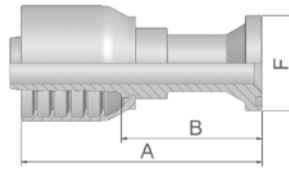

XXXXX-XX-XX Part Number 71	Hose I.D.				Flange	A mm	B mm	F mm
	DN	Inch	Size	mm				
11571-8-8	12	1/2	-8	12.7	1/2	89	54	30
11571-12-12	20	3/4	-12	19.1	3/4	98	59	38
11571-16-12	20	3/4	-12	19.1	1	70	31	45
11571-16-16	25	1	-16	25.4	1	108	63	45
11571-20-16	25	1	-16	25.4	1-1/4	83	36	51
11571-20-20	32	1-1/4	-20	31.8	1-1/4	120	72	51
11571-24-20	32	1-1/4	-20	31.8	1-1/2	82	35	60
11571-32-20	32	1-1/4	-20	31.8	2	109	62	71
11571-20-24	40	1-1/2	-24	38.1	1-1/4	138	77	51
11571-24-24	40	1-1/2	-24	38.1	1-1/2	140	79	60
11571-32-32	50	2	-32	50.8	2	144	79	71

Find SAE flange halves in section Eb.

Fittings with standard O-ring seals can be used for temperatures from -30 °C up to +105 °C.

Special O-rings are available on request.

## 16 SAE Code 61 – Flange Head 22.5° Elbow

ISO 12151-3-E22ML – SFL 22.5°  
3000 psi

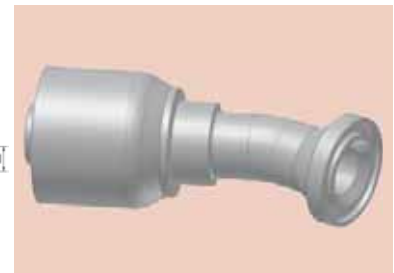
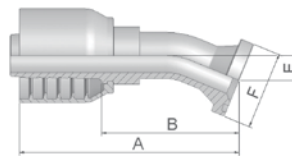

XXXXX-XX-XX Part Number 71	Hose I.D.				Flange	A mm	B mm	E mm	F mm
	DN	Inch	Size	mm					
11671-12-12	20	3/4	-12	19.1	3/4	105	65	11	38
11671-16-16	25	1	-16	25.4	1	125	80	11	45
11671-20-20	32	1-1/4	-20	31.8	1-1/4	139	92	13	51
11671-24-24	40	1-1/2	-24	38.1	1-1/2	149	94	16	60
11671-32-32	50	2	-32	50.8	2	185	131	22	71

Find SAE flange halves in section Eb.

Fittings with standard O-ring seals can be used for temperatures from -30 °C up to +105 °C.

Special O-rings are available on request.

Approved **fitting series** for hose types:

71 774 721TC 772LT

# 17 SAE Code 61 – Flange Head 45° Elbow

ISO 12151-3 – E45 – L – SFL 45°  
3000 psi

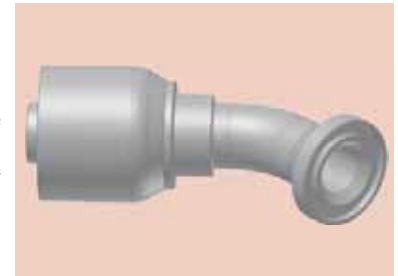
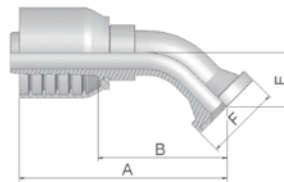

XXXXX-XX-XX Part Number 71	Hose I.D.				Flange	A mm	B mm	E mm	F mm
	DN	Inch	Size	mm					
11771-12-12	20	3/4	-12	19.1	3/4	97	58	26	38
11771-16-12	20	3/4	-12	19.1	1	97	57	25	45
11771-16-16	25	1	-16	25.4	1	121	74	32	45
11771-20-16	25	1	-16	25.4	1-1/4	121	76	32	51
11771-20-20	32	1-1/4	-20	31.8	1-1/4	141	94	38	51
11771-24-20	32	1-1/4	-20	31.8	1-1/2	141	94	38	60
11771-24-24	40	1-1/2	-24	38.1	1-1/2	173	113	44	60
11771-32-32	50	2	-32	50.8	2	200	135	52	71

Find SAE flange halves in section Eb.

Fittings with standard O-ring seals can be used for temperatures from -30 °C up to +105 °C.  
Special O-rings are available on request.

# 19 SAE Code 61 – Flange Head 90° Elbow

ISO 12151-3 – E-L – SFL 90°  
3000 psi

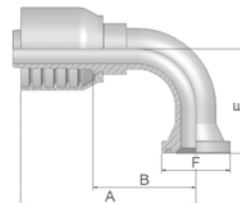

XXXXX-XX-XX Part Number 71	Hose I.D.				Flange	A mm	B mm	E mm	F mm
	DN	Inch	Size	mm					
11971-8-8	12	1/2	-8	12.7	1/2	75	40	41	30
11971-12-8	12	1/2	-8	12.7	3/4	77	42	42	38
11971-12-12	20	3/4	-12	19.1	3/4	89	50	58	38
11971-16-12	20	3/4	-12	19.1	1	90	50	58	45
11971-20-12	20	3/4	-12	19.1	1-1/4	90	50	70	51
11971-16-16	25	1	-16	25.4	1	113	72	60	45
11971-20-16	25	1	-16	25.4	1-1/4	113	68	70	51
11971-24-16	25	1	-16	25.4	1-1/2	113	72	60	60
11971-20-20	32	1-1/4	-20	31.8	1-1/4	130	82	90	51
11971-24-20	32	1-1/4	-20	31.8	1-1/2	129	82	90	60
11971-24-24	40	1-1/2	-24	38.1	1-1/2	161	101	104	60
11971-32-32	50	2	-32	50.8	2	203	138	138	71
11971-40-32	50	2	-32	50.8	2-1/2	187	133	114	84

Find SAE flange halves in section Eb.

Fittings with standard O-ring seals can be used for temperatures from -30 °C up to +105 °C.  
Special O-rings are available on request.

Approved fitting series for hose types:

71 774 721TC 772LT

## 6A SAE Code 62 Flange Straight

ISO 12151-3-S-S – SFS  
6000 psi

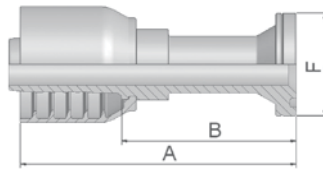

XXXXX-XX-XX Part Number 71	Hose I.D.				Flange	A mm	B mm	F mm
	DN	Inch	Size	mm				
16A71-12-12	20	3/4	-12	19.1	3/4	105	66	41
16A71-16-12	20	3/4	-12	19.1	1	79	39	48
16A71-16-16	25	1	-16	25.4	1	127	82	48
16A71-20-16	25	1	-16	25.4	1-1/4	127	82	54
16A71-20-20	32	1-1/4	-20	31.8	1-1/4	130	83	54
16A71-24-20	32	1-1/4	-20	31.8	1-1/2	107	53	64
16A71-24-24	40	1-1/2	-24	38.1	1-1/2	163	107	64
16A71-32-32	50	2	-32	50.8	2	187	133	79

Find SAE flange halves in section Eb.  
Fittings with standard O-ring seals can be used for temperatures from -30 °C up to +105 °C.  
Special O-rings are available on request.

## 6F SAE Code 62 Flange 45° Elbow – Heavy Series

ISO 12151-3 – E45-S – SFS 45°  
6000 psi

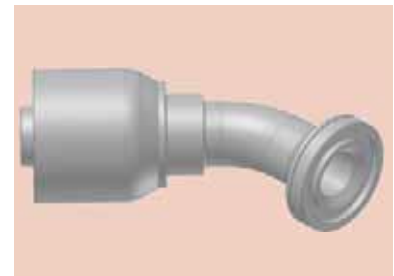
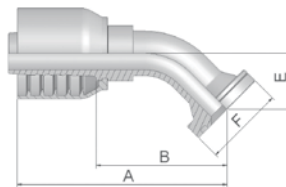

XXXXX-XX-XX Part Number 71	Hose I.D.				Flange	A mm	B mm	E mm	F mm
	DN	Inch	Size	mm					
16F71-8-8	12	1/2	-8	12.7	1/2	81	46	19	31.75
16F71-12-12	20	3/4	-12	19.1	3/4	105	66	26	41
16F71-16-12	20	3/4	-12	19.1	1	101	62	26	48
16F71-12-16	25	1	-16	25.4	3/4	118	73	27	41
16F71-16-16	25	1	-16	25.4	1	119	74	32	48
16F71-20-16	25	1	-16	25.4	1-1/4	120	73	32	54
16F71-20-20	32	1-1/4	-20	31.8	1-1/4	141	94	38	54
16F71-24-20	32	1-1/4	-20	31.8	1-1/2	141	94	38	64
16F71-24-24	40	1-1/2	-24	38.1	1-1/2	173	113	44	64
16F71-32-32	50	2	-32	50.8	2	198	144	52	79

Find SAE flange halves in section Eb.  
Fittings with standard O-ring seals can be used for temperatures from -30 °C up to +105 °C.  
Special O-rings are available on request.

Approved **fitting series** for hose types:

71 774 721TC 772LT

# 6N

## SAE Code 62 Flange 90° Elbow

ISO 12151-3 – E-S – SFS 90°  
6000 psi

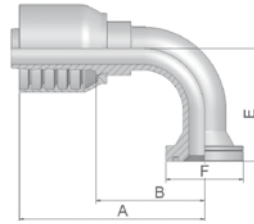

XXXXX-XX-XX Part Number 71	Hose I.D.				Flange	A mm	B mm	E mm	F mm
	DN	Inch	Size	mm					
16N71-12-12	20	3/4	-12	19.1	3/4	98	59	54	41
16N71-16-12	20	3/4	-12	19.1	1	93	53	53	48
16N71-16-16	25	1	-16	25.4	1	111	64	70	48
16N71-20-16	25	1	-16	25.4	1-1/4	115	68	61	54
16N71-20-20	32	1-1/4	-20	31.8	1-1/4	129	82	90	54
16N71-24-20	32	1-1/4	-20	31.8	1-1/2	130	82	70	64
16N71-24-24	40	1-1/2	-24	38.1	1-1/2	161	101	81	64
16N71-32-32	50	2	-32	50.8	2	188	134	114	79

Find SAE flange halves in section Eb.  
Fittings with standard O-ring seals can be used for temperatures from -30 °C up to +105 °C.  
Special O-rings are available on request.

Approved **fitting series** for hose types:

71 774 721TC 772LT

## JC Female ORFS Swivel – Straight Short

ISO 12151-1 – SWSA  
SAE J516 – ORFS

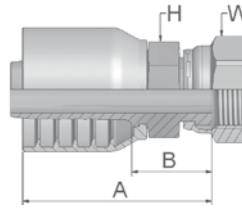

XXXXX-XX-XX Part Number 71	Hose I.D.				Thread UNF	A mm	B mm	H mm	W mm
	DN	Inch	Size	mm					
1JC71-12-10-SM	16	5/8	-10	15.9	1-3/16x12	68	29	32	36
1JC71-16-12-SM	20	3/4	-12	19.1	1-7/16x12	72	33	36	41
1JC71-12-16-SM	25	1	-16	25.4	1-3/16x12	76	31	36	36
1JC71-16-16-SM	25	1	-16	25.4	1-7/16x12	80	35	36	41
1JC71-20-20-SM	32	1-1/4	-20	31.8	1-11/16x12	85	36	50	50
1JC71-24-24-SM	40	1-1/2	-24	38.1	2x12	102	42	50	60

## JS ORFS Swivel Female (Long)

ISO 12151-1-SWSB  
SAE J516 – ORFS

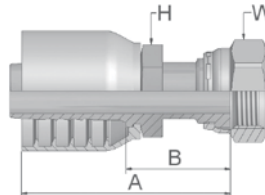

XXXXX-XX-XX Part Number 71	Hose I.D.				Thread UNF	A mm	B mm	H mm	W mm
	DN	Inch	Size	mm					
1JS71-8-8-SM	12	1/2	-8	12.7	13/16x16	67	33	22	24
1JS71-10-10-SM	16	5/8	-10	15.9	1x14	79	39	24	30
1JS71-12-12-SM	20	3/4	-12	19.1	1-3/16x12	84	45	30	36
1JS71-16-12-SM	20	3/4	-12	19.1	1-7/16x12	86	47	36	41
1JS71-16-16-SM	25	1	-16	25.4	1-7/16x12	94	47	36	41
1JS71-24-24-SM	40	1-1/2	-24	38.1	2x12	118	58	50	60

Approved **fitting series** for hose types:

SM: Metric Hexagon

71 774 721TC 772LT

## J7 Female ORFS – Swivel 45° Elbow

ISO 12151-1 – SWE 45°  
SAE J516 – ORFS 45°

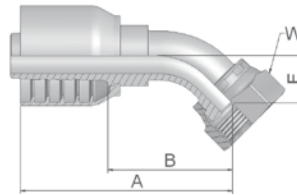

XXXXX-XX-XX Part Number 71	Hose I.D.				Thread UNF	A mm	B mm	E mm	W mm
	DN	Inch	Size	mm					
1J771-8-8-SM	12	1/2	-8	12.7	13/16x16	72	37	15	24
1J771-12-10-SM	16	5/8	-10	15.9	1-3/16x12	90	53	21	36
1J771-12-12-SM	20	3/4	-12	19.1	1-3/16x12	92	53	21	36
1J771-16-12-SM	20	3/4	-12	19.1	1-7/16x12	95	56	24	41
1J771-16-16-SM	25	1	-16	25.4	1-7/16x12	113	66	24	41
1J771-20-20	32	1-1/4	-20	31.8	1-11/16x12	130	82	27	50
1J771-24-24-SM	40	1-1/2	-24	38.1	2x12	169	109	40	60

## J9 Female ORFS – Swivel 90° Elbow – Short Drop

ISO 12151-1 – SWES  
SAE J516 – ORFS 90°

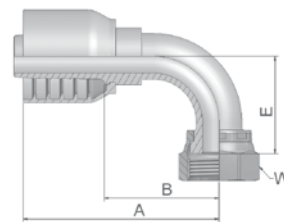

XXXXX-XX-XX Part Number 71	Hose I.D.				Thread UNF	A mm	B mm	E mm	W mm
	DN	Inch	Size	mm					
1J971-6-6-SM	10	3/8	-6	9.5	11/16x16	58	29	23	22
1J971-8-8-SM	12	1/2	-8	12.7	13/16x16	70	35	29	24
1J971-10-10-SM	16	5/8	-10	15.9	1x14	78	39	33	30
1J971-12-12-SM	20	3/4	-12	19.1	1-3/16x12	89	49	48	36
1J971-16-16-SM	25	1	-16	25.4	1-7/16x12	111	64	56	41
1J971-20-20-SM	32	1-1/4	-20	31.8	1-11/16x12	130	83	64	50

Approved fitting series for hose types:

SM: Metric Hexagon

71 774 721TC 772LT

# XU Female Metric – Swivel Straight (30° Flare)

JIS B8363

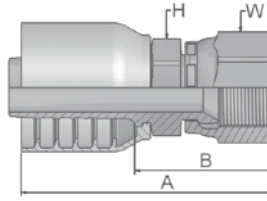

XXXXX-XX-XX Part Number 71	Hose I.D.				Thread metric	A mm	B mm	H mm	W mm
	DN	Inch	Size	mm					
1XU71-10-10	16	5/8	-10	15.9	M24x1.5	67	28	30	32
1XU71-12-12	20	3/4	-12	19.1	M30x1.5	68	28	36	36
1XU71-16-16	25	1	-16	25.4	M33x1.5	82	35	36	41
1XU71-20-20	32	1-1/4	-20	31.8	M36x1.5	106	64	46	46
1XU71-24-24	40	1-1/2	-24	38.1	M42x1.5	125	71	55	55





Approved **fitting series** for hose types:

71 774 721TC 772LT













## DIN – Metric

Page Dd-1 – Dd-2			
<p><b>C9</b> Dd-1</p>  <p>Female Metric 24° – Swivel Heavy Series with O-Ring Straight ISO 12151-2-SWS-S – DKOS</p>	<p><b>0C</b> Dd-1</p>  <p>Female Metric 24° – Swivel Heavy Series with O-Ring 45° Elbow ISO 12151-2-SWE 45°-S – DKOS 45°</p>	<p><b>1C</b> Dd-2</p>  <p>Female Metric 24° – Swivel Heavy Series with O-Ring 90° Elbow ISO 12151-2-SWE-S – DKOS 90°</p>	<p><b>D2</b> Dd-2</p>  <p>Male Metric 24° – Rigid Heavy Series – Straight ISO 12151-2-S-S – CES</p>











## BSP

Page Dd-3 – Dd-4			
<p><b>92</b> Dd-3</p>  <p>Female BSP Parallel Pipe Swivel – Straight (60° Cone) BS5200-A – DKR</p>	<p><b>B1</b> Dd-3</p>  <p>Female BSP Parallel Pipe Swivel 45° Elbow (60° Cone) BS 5200-D – DKR 45°</p>	<p><b>B2</b> Dd-4</p>  <p>Female BSP Parallel Pipe Swivel 90° Elbow (60° Cone) BS 5200-B – DKR 90°</p>	<p><b>D9</b> Dd-4</p>  <p>Male BSP Parallel Pipe Rigid – Straight (60° Cone) BS5200 – AGR</p>





## SAE

Page Dd-5 – Dd-7			
<p><b>01</b> Dd-5</p>  <p>Male NPTF Pipe Rigid – Straight SAE J476A / J516 – AGN</p>	<p><b>03</b> Dd-5</p>  <p>Male JIC 37° – Rigid Straight ISO12151-5-S – AGJ</p>	<p><b>06</b> Dd-6</p>  <p>Female JIC 37° – Swivel Straight ISO12151-5-SWS – DKJ</p>	<p><b>37</b> Dd-6</p>  <p>Female JIC 37° – Swivel 45° Elbow ISO 12151-5-SWE 45° – DKJ 45°</p>
<p><b>39</b> Dd-7</p>  <p>Female JIC 37° – Swivel 90° Elbow ISO 12151-5-SWES – DKJ 90°</p>			



## Flange

Page Dd-8 – Dd-12			
<p><b>15/4A</b> Dd-8</p>  <p>SAE Code 61 Flange Straight ISO 12151-3-S-L-SFL 5000 psi</p>	<p><b>17/4F</b> Dd-8</p>  <p>SAE Code 61 Flange 45° Elbow ISO 12151-3-E45S-L-SFL 45° 5000 psi</p>	<p><b>19/4N</b> Dd-9</p>  <p>SAE Code 61 Flange 90° Elbow ISO 12151-3-E-L-SFL 90° 5000 psi</p>	<p><b>6A</b> Dd-9</p>  <p>SAE Code 62 Flange Straight ISO 12151-3-S-S-SFS 6000 psi</p>
<p><b>6F</b> Dd-10</p>  <p>SAE Code 62 Flange 45° Elbow – Heavy Series ISO 12151-3-E45-S-SFS 45° 6000 psi</p>	<p><b>6N</b> Dd-10</p>  <p>SAE Code 62 Flange 90° Elbow ISO 12151-3-E-S-SFS 90° 6000 psi</p>	<p><b>XA</b> Dd-11</p>  <p>Caterpillar® Flange Straight</p>	<p><b>XF</b> Dd-11</p>  <p>Caterpillar® Flange 45° Elbow</p>
<p><b>XG</b> Dd-12</p>  <p>Caterpillar® Flange 60° Elbow</p>	<p><b>XN</b> Dd-12</p>  <p>Caterpillar® Flange 90° Elbow</p>		

## ORFS

Page Dd-13 – Dd-15			
<p><b>JC</b> Dd-13</p>  <p>Female ORFS Swivel – Straight Short ISO 12151-1-SWSA SAE J516 – ORFS</p>	<p><b>JS</b> Dd-13</p>  <p>ORFS Swivel Female (Long) ISO 12151-1-SWSB SAE J516 – ORFS</p>	<p><b>J7</b> Dd-14</p>  <p>Female ORFS – Swivel 45° Elbow ISO 12151-1-SWE 45° SAE J516 – ORFS 45°</p>	<p><b>J9</b> Dd-14</p>  <p>Female ORFS – Swivel 90° Elbow – Short Drop ISO 12151-1-SWES SAE J516 – ORFS 90°</p>
<p><b>JM</b> Dd-15</p>  <p>ORFS Male ISO 12151-1-S – SAE J516</p>			

## French Standard

Page Dd-16	
<p><b>F2</b> Dd-16</p>  <p>Female French Gas Series Swivel – 90° Elbow</p>	<p><b>F4</b> Dd-16</p>  <p>Female French Gas Series Swivel – Straight (Ball Nose)</p>

## Others

Page Dd-17	
<p><b>XU</b> Dd-17</p>  <p>Female Metric – Swivel Straight (30° Flare) JIS B8363</p>	



## C9 Female Metric 24° – Swivel Heavy Series with O-Ring Straight

ISO 12151-2-SWS-S – DKOS

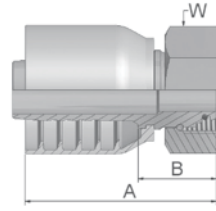

XXXXX-XX-XX Part Number 73	Hose I.D.				Thread metric	Tube O.D. mm	A mm	B mm	W mm
	DN	Inch	Size	mm					
1C973-20-12	20	3/4	-12	19.1	M30x2	20	81	33	36
1C973-25-12	20	3/4	-12	19.1	M36x2	25	79	31	46
1C973-25-16	25	1	-16	25.4	M36x2	25	87	36	46
1C973-30-16	25	1	-16	25.4	M42x2	30	87	36	50
1C973-30-20	32	1-1/4	-20	31.8	M42x2	30	106	42	50
1C973-38-20	32	1-1/4	-20	31.8	M52x2	38	101	37	60
1C973-38-24	40	1-1/2	-24	38.1	M52x2	38	105	42	60

Fittings with standard O-ring seals can be used for temperatures from -30 °C up to +105 °C.  
Find O-rings in section E. Special O-rings are available on request.

## OC Female Metric 24° – Swivel Heavy Series with O-Ring 45° Elbow

ISO 12151-2 – SWE 45°-S – DKOS 45°

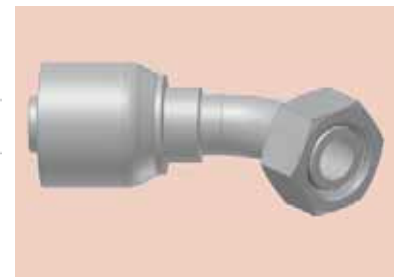
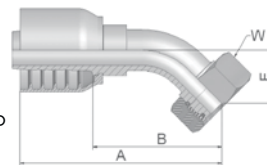

XXXXX-XX-XX Part Number 73	Hose I.D.				Thread metric	Tube O.D. mm	A mm	B mm	E mm	W mm
	DN	Inch	Size	mm						
10C73-20-12	20	3/4	-12	19.1	M30x2	20	112	64	28	36
10C73-25-12	20	3/4	-12	19.1	M36x2	25	112	64	29	46
10C73-30-16	25	1	-16	25.4	M42x2	30	131	81	34	50
10C73-38-20	32	1-1/4	-20	31.8	M52x2	38	161	97	37	60

Fittings with standard O-ring seals can be used for temperatures from -30 °C up to +105 °C.  
Find O-rings in section E. Special O-rings are available on request.

Approved **fitting series** for hose types:

73 731

# 1C Female Metric 24° – Swivel Heavy Series with O-Ring 90° Elbow

ISO 12151-2-SWE-S – DKOS 90°

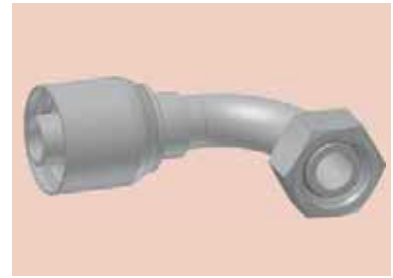
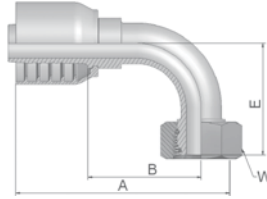

XXXXX-XX-XX Part Number 73	Hose I.D.				Thread metric	Tube O.D. mm	A mm	B mm	E mm	W mm
	DN	Inch	Size	mm						
11C73-20-12	20	3/4	-12	19.1	M30x2	20	101	53	57	36
11C73-25-12	20	3/4	-12	19.1	M36x2	25	101	53	59	46
11C73-25-16	25	1	-16	25.4	M36x2	25	122	71	70	46
11C73-30-16	25	1	-16	25.4	M42x2	30	122	71	73	50
11C73-30-20	32	1-1/4	-20	31.8	M42x2	30	138	73	74	50
11C73-38-20	32	1-1/4	-20	31.8	M52x2	38	151	87	78	60

Fittings with standard O-ring seals can be used for temperatures from -30 °C up to +105 °C.  
Find O-rings in section E. Special O-rings are available on request.

# D2 Male Metric 24° – Rigid Heavy Series – Straight

ISO 12151-2-S-S – CES

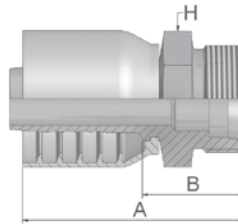

XXXXX-XX-XX Part Number 73	Hose I.D.				Thread metric	Tube O.D. mm	A mm	B mm	H mm
	DN	Inch	Size	mm					
1D273-20-12	20	3/4	-12	19.1	M30x2	20	84	35	30
1D273-25-12	20	3/4	-12	19.1	M36x2	25	86	38	36
1D273-30-16	25	1	-16	25.4	M42x2	30	94	42	46
1D273-38-20	32	1-1/4	-20	31.8	M52x2	38	112	46	55

Approved **fitting series** for hose types:

73 731

## 92 Female BSP Parallel Pipe Swivel – Straight (60° Cone)

BS5200-A – DKR

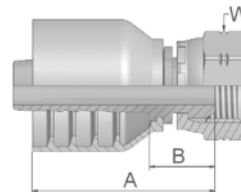

XXXXX-XX-XX Part Number 73	Hose I.D.				Thread BSP	A mm	B mm	W mm
	DN	Inch	Size	mm				
19273-12-12	20	3/4	-12	19.1	3/4x14	77	29	32
19273-16-16	25	1	-16	25.4	1x11	89	38	41
19273-20-20	32	1-1/4	-20	31.8	1-1/4x11	101	37	50
19273-24-24	40	1-1/2	-24	38.1	1-1/2x11	100	37	55
19273-32-32	50	2	-32	50.8	2x11	113	38	70

## B1 Female BSP Parallel Pipe Swivel 45° Elbow (60° Cone)

BS 5200-D – DKR 45°

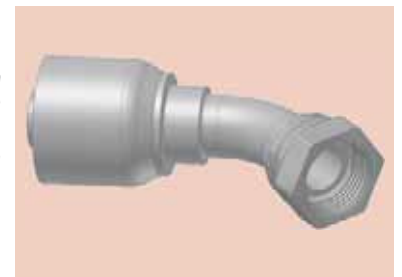
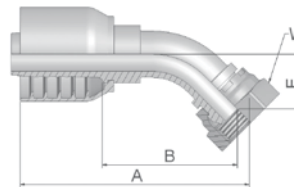

XXXXX-XX-XX Part Number 73	Hose I.D.				Thread BSP	A mm	B mm	E mm	W mm
	DN	Inch	Size	mm					
1B173-12-12	20	3/4	-12	19.1	3/4x14	110	62	26	32
1B173-16-16	25	1	-16	25.4	1x11	136	84	39	41
1B173-20-20	32	1-1/4	-20	31.8	1-1/4x11	168	104	43	50
1B173-24-24	40	1-1/2	-24	38.1	1-1/2x11	186	123	52	55
1B173-32-32	50	2	-32	50.8	2x11	249	177	70	70

Approved **fitting series** for hose types:

73 731

## B2 Female BSP Parallel Pipe Swivel 90° Elbow (60° Cone)

BS 5200-B – DKR 90°

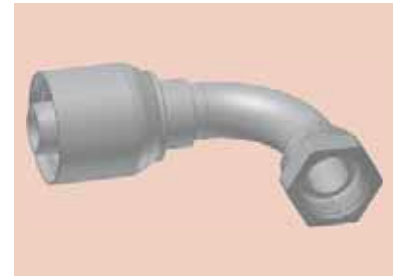
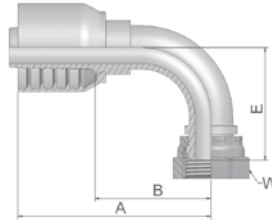

XXXXX-XX-XX Part Number 73	Hose I.D.				Thread BSP	A mm	B mm	E mm	W mm
	DN	Inch	Size	mm					
1B273-12-12	20	3/4	-12	19.1	3/4x14	106	58	55	32
1B273-16-16	25	1	-16	25.4	1x11	121	70	76	41
1B273-20-20	32	1-1/4	-20	31.8	1-1/4x11	151	87	80	50
1B273-24-24	40	1-1/2	-24	38.1	1-1/2x11	166	103	103	55
1B273-32-32	50	2	-32	50.8	2x11	229	157	121	70

## D9 Male BSP Parallel Pipe Rigid – Straight (60° Cone)

BS5200 – AGR

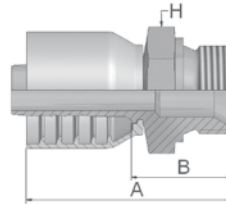

XXXXX-XX-XX Part Number 73	Hose I.D.				Thread BSP	A mm	B mm	H mm
	DN	Inch	Size	mm				
1D973-12-12	20	3/4	-12	19.1	3/4x14	87	39	32
1D973-16-16	25	1	-16	25.4	1x11	96	43	41
1D973-20-20	32	1-1/4	-20	31.8	1-1/4x11	113	49	50
1D973-24-24	40	1-1/2	-24	38.1	1-1/2x11	114	51	55
1D973-32-32	50	2	-32	50.8	2x11	129	58	70

Approved **fitting series** for hose types:

73 731



# 01

## Male NPTF Pipe Rigid – Straight

SAE J476A / J516 – AGN

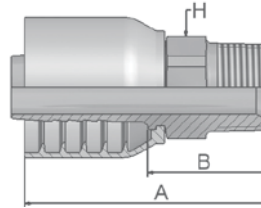

XXXXX-XX-XX Part Number 73	Hose I.D.				Thread NPTF	A mm	B mm	H mm Inch
	DN	Inch	Size	mm				
10173-12-12-SM	20	3/4	-12	19.1	3/4x14	90	42	30
10173-16-16-SM	25	1	-16	25.4	1x11-1/2	100	50	36
10173-20-20-SM	32	1-1/4	-20	31.8	1-1/4x11-1/2	125	61	46
10173-24-24	40	1-1/2	-24	38.1	1-1/2x11-1/2	124	61	50
10173-32-32	50	2	-32	50.8	2x11-1/2	141	73	2-1/2

# 03

## Male JIC 37° – Rigid Straight

ISO12151-5-S – AGJ

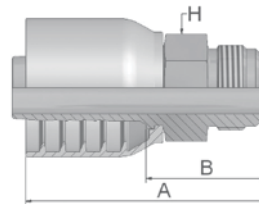

XXXXX-XX-XX Part Number 73	Hose I.D.				Thread UNF	A mm	B mm	H mm
	DN	Inch	Size	mm				
10373-12-12-SM	20	3/4	-12	19.1	1-1/16x12	89	41	30
10373-16-12	20	3/4	-12	19.1	1-5/16x12	91	43	36
10373-16-16-SM	25	1	-16	25.4	1-5/16x12	97	47	36
10373-20-16	25	1	-16	25.4	1-5/8x12	102	52	46
10373-20-20-SM	32	1-1/4	-20	31.8	1-5/8x12	118	54	46
10373-24-20	32	1-1/4	-20	31.8	1-7/8x12	118	54	50
10373-24-24-SM	40	1-1/2	-24	38.1	1-7/8x12	122	59	50
10373-32-32-SM	50	2	-32	50.8	2-1/2x12	143	72	65

Approved **fitting series** for hose types:

SM: Metric Hexagon

73 731

## 06 Female JIC 37° – Swivel Straight

ISO12151-5-SWS – DKJ

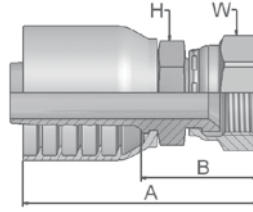

XXXXX-XX-XX Part Number 73	Hose I.D.				Thread UNF	A mm	B mm	H mm Inch	W mm Inch
	DN	Inch	Size	mm					
10673-12-12-SM	20	3/4	-12	19.1	1-1/16x12	93	45	30	32
10673-16-12	20	3/4	-12	19.1	1-5/16x12	95	47	1-3/8	1-1/2
10673-16-16-SM	25	1	-16	25.4	1-5/16x12	103	52	36	41
10673-20-16	25	1	-16	25.4	1-5/8x12	108	60	1-3/4	2
10673-16-20-SM	32	1-1/4	-20	31.8	1-5/16x12	116	52	46	41
10673-20-20-SM	32	1-1/4	-20	31.8	1-5/8x12	125	61	46	50
10673-24-20-SM	32	1-1/4	-20	31.8	1-7/8x12	130	66	50	60
10673-24-24-SM	40	1-1/2	-24	38.1	1-7/8x12	128	66	50	60

## 37 Female JIC 37° – Swivel 45° Elbow

ISO 12151-5-SWE 45° – DKJ 45°

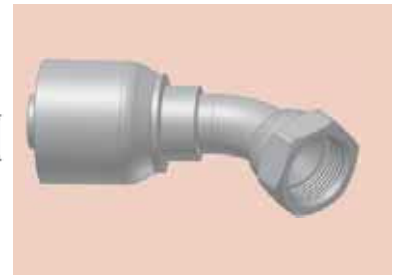
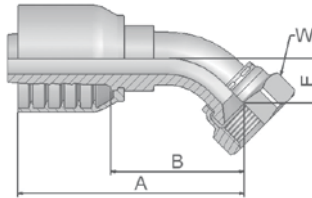

XXXXX-XX-XX Part Number 73	Hose I.D.				Thread UNF	A mm	B mm	E mm	W mm
	DN	Inch	Size	mm					
13773-12-12-SM	20	3/4	-12	19.1	1-1/16x12	104	56	22	32
13773-16-12	20	3/4	-12	19.1	1-5/16x12	107	59	24	41
13773-16-16-SM	25	1	-16	25.4	1-5/16x12	119	69	24	41
13773-20-16-SM	25	1	-16	25.4	1-5/8x12	143	92	47	50
13773-20-20-SM	32	1-1/4	-20	31.8	1-5/8x12	172	108	47	50
13773-24-24-SM	40	1-1/2	-24	38.1	1-7/8x12	194	132	58	60
13773-32-32-SM	50	2	-32	50.8	2-1/2x12	251	179	72	75

Approved fitting series for hose types:

SM: Metric Hexagon

73 731

# 39 Female JIC 37° – Swivel 90° Elbow

ISO 12151-5-SWES – DKJ 90°

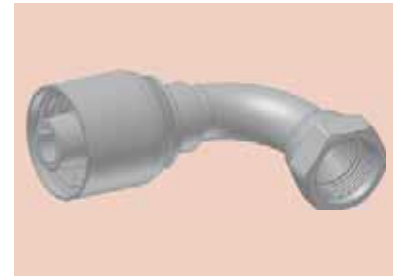
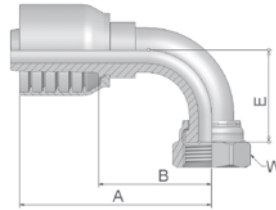

XXXXX-XX-XX Part Number 73	Hose I.D.				Thread UNF	A mm	B mm	E mm	W mm
	DN	Inch	Size	mm					
13973-12-12-SM	20	3/4	-12	19.1	1-1/16x12	101	53	48	32
13973-16-12-SM	20	3/4	-12	19.1	1-5/16x12	101	53	56	41
13973-16-16-SM	25	1	-16	25.4	1-5/16x12	118	67	56	41
13973-20-16	25	1	-16	25.4	1-5/8x12	118	67	85	50
13973-20-20-SM	32	1-1/4	-20	31.8	1-5/8x12	151	87	85	50
13973-24-24-SM	40	1-1/2	-24	38.1	1-7/8x12	194	119	102	60
13973-32-32-SM	50	2	-32	50.8	2-1/2x12	229	157	152	75

Approved **fitting series** for hose types:

SM: Metric Hexagon

73 731

## 15/4A SAE Code 61 Flange Straight

ISO 12151-3-S-L – SFL  
5000 psi

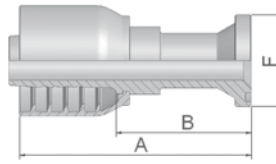

XXXXX-XX-XX Part Number 73	Hose I.D.				Flange	A mm	B mm	F mm
	DN	Inch	Size	mm				
11573-12-12	20	3/4	-12	19.1	3/4	110	62	38
11573-16-12	20	3/4	-12	19.1	1	91	43	45
11573-16-16	25	1	-16	25.4	1	117	67	45
14A73-20-16	25	1	-16	25.4	1-1/4	85	34	51
11573-16-20	32	1-1/4	-20	31.8	1	133	69	45
14A73-20-20	32	1-1/4	-20	31.8	1-1/4	141	77	51
14A73-24-20	32	1-1/4	-20	31.8	1-1/2	104	40	60
14A73-24-24	40	1-1/2	-24	38.1	1-1/2	166	103	60
14A73-32-24	40	1-1/2	-24	38.1	2	113	50	71
14A73-32-32	50	2	-32	50.8	2	220	148	71

Find SAE flange halves in section Eb.

Fittings with standard O-ring seals can be used for temperatures from -30 °C up to +105 °C.

Find O-rings in section E. Special O-rings are available on request.

## 17/4F SAE Code 61 Flange 45° Elbow

ISO 12151-3 – E45S – L – SFL 45°  
5000 psi

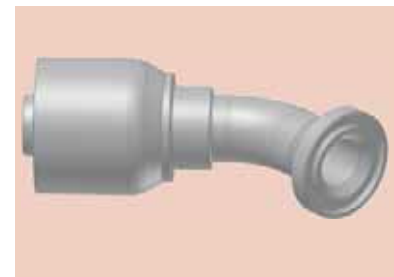
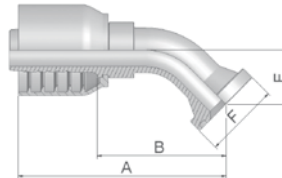

XXXXX-XX-XX Part Number 73	Hose I.D.				Flange	A mm	B mm	E mm	F mm
	DN	Inch	Size	mm					
11773-12-12	20	3/4	-12	19.1	3/4	119	71	27	38
11773-16-12	20	3/4	-12	19.1	1	109	64	26	44
11773-16-16	25	1	-16	25.4	1	127	77	32	45
14F73-20-16	25	1	-16	25.4	1-1/4	136	85	32	51
14F73-20-20	32	1-1/4	-20	31.8	1-1/4	160	96	35	51
14F73-24-20	32	1-1/4	-20	31.8	1-1/2	162	102	38	60
14F73-24-24	40	1-1/2	-24	38.1	1-1/2	178	115	44	60
14F73-32-24	40	1-1/2	-24	38.1	2	177	114	43	71

Find SAE flange halves in section Eb.

Fittings with standard O-ring seals can be used for temperatures from -30 °C up to +105 °C.

Find O-rings in section E. Special O-rings are available on request.

Approved **fitting series** for hose types:

73 731

# 19/4N SAE Code 61 Flange 90° Elbow

ISO 12151-3-E-L – SFL 90°  
5000 psi

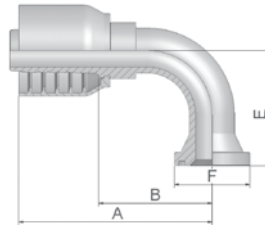

XXXXX-XX-XX Part Number 73	Hose I.D.				Flange	A mm	B mm	E mm	F mm
	DN	Inch	Size	mm					
11973-12-12	20	3/4	-12	19.1	3/4	109	61	58	38
11973-16-12	20	3/4	-12	19.1	1	102	54	58	45
11973-12-16	25	1	-16	25.4	3/4	111	61	72	38
11973-16-16	25	1	-16	25.4	1	118	67	70	45
14N73-20-16	25	1	-16	25.4	1-1/4	128	78	68	51
14N73-20-20	32	1-1/4	-20	31.8	1-1/4	155	91	90	51
14N73-24-20	32	1-1/4	-20	31.8	1-1/2	155	91	90	60
14N73-24-24	40	1-1/2	-24	38.1	1-1/2	166	103	104	60
14N73-32-24	40	1-1/2	-24	38.1	2	166	103	92	71
14N73-32-32	50	2	-32	50.8	2	220	148	133	71

Find SAE flange halves in section Eb.

Fittings with standard O-ring seals can be used for temperatures from -30 °C up to +105 °C.  
Find O-rings in section E. Special O-rings are available on request.

# 6A SAE Code 62 Flange Straight

ISO 12151-3-S-S – SFS  
6000 psi

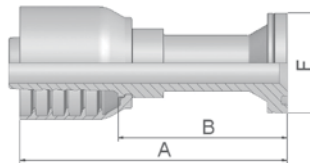

XXXXX-XX-XX Part Number 73	Hose I.D.				Flange	A mm	B mm	F mm
	DN	Inch	Size	mm				
16A73-12-12	20	3/4	-12	19.1	3/4	130	82	41
16A73-16-12	20	3/4	-12	19.1	1	135	87	48
16A73-12-16	25	1	-16	25.4	3/4	136	85	41
16A73-16-16	25	1	-16	25.4	1	131	81	48
16A73-20-16	25	1	-16	25.4	1-1/4	100	50	54
16A73-16-20	32	1-1/4	-20	31.8	1	149	85	48
16A73-20-20	32	1-1/4	-20	31.8	1-1/4	149	85	54
16A73-24-20	32	1-1/4	-20	31.8	1-1/2	121	57	64
16A73-20-24	40	1-1/2	-24	38.1	1-1/4	158	96	54
16A73-24-24	40	1-1/2	-24	38.1	1-1/2	166	104	64
16A73-32-24	40	1-1/2	-24	38.1	2	129	66	79
16A73-32-32	50	2	-32	50.8	2	194	122	79

Find SAE flange halves in section Eb.

Fittings with standard O-ring seals can be used for temperatures from -30 °C up to +105 °C.  
Find O-rings in section E. Special O-rings are available on request.

Approved **fitting series** for hose types:

73 731

## 6F SAE Code 62 Flange 45° Elbow – Heavy Series

ISO 12151-3 – E45-S – SFS 45°  
6000 psi

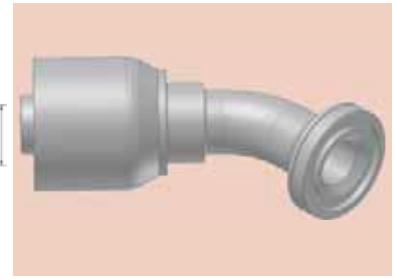
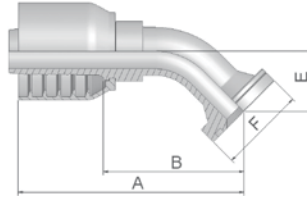

XXXXX-XX-XX Part Number 73	Hose I.D.				Flange	A mm	B mm	E mm	F mm
	DN	Inch	Size	mm					
16F73-12-12	20	3/4	-12	19.1	3/4	110	62	26	41
16F73-16-12	20	3/4	-12	19.1	1	110	62	26	48
16F73-12-16	25	1	-16	25.4	3/4	123	73	32	41
16F73-16-16	25	1	-16	25.4	1	129	79	32	48
16F73-20-16	25	1	-16	25.4	1-1/4	129	79	32	54
16F73-16-20	32	1-1/4	-20	31.8	1	157	93	33	48
16F73-20-20	32	1-1/4	-20	31.8	1-1/4	163	98	38	54
16F73-24-20	32	1-1/4	-20	31.8	1-1/2	163	99	38	63
16F73-24-24	40	1-1/2	-24	38.1	1-1/2	178	115	44	64
16F73-32-32	50	2	-32	50.8	2	230	158	56	79

Find SAE flange halves in section Eb.

Fittings with standard O-ring seals can be used for temperatures from -30 °C up to +105 °C.

Find O-rings in section E. Special O-rings are available on request.

## 6N SAE Code 62 Flange 90° Elbow

ISO 12151-3 – E-S – SFS 90°  
6000 psi

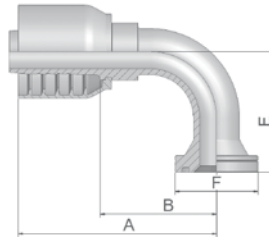

XXXXX-XX-XX Part Number 73	Hose I.D.				Flange	A mm	B mm	E mm	F mm
	DN	Inch	Size	mm					
16N73-12-12	20	3/4	-12	19.1	3/4	101	53	58	41
16N73-16-12	20	3/4	-12	19.1	1	111	63	58	48
16N73-20-12	20	3/4	-12	19.1	1-1/4	111	63	63	54
16N73-12-16	25	1	-16	25.4	3/4	108	57	70	41
16N73-16-16	25	1	-16	25.4	1	122	71	70	48
16N73-20-16	25	1	-16	25.4	1-1/4	122	71	70	54
16N73-16-20	32	1-1/4	-20	31.8	1	137	73	90	48
16N73-20-20	32	1-1/4	-20	31.8	1-1/4	172	108	90	54
16N73-24-20	32	1-1/4	-20	31.8	1-1/2	172	108	76	64
16N73-24-24	40	1-1/2	-24	38.1	1-1/2	166	103	104	64
16N73-32-32	50	2	-32	50.8	2	229	157	138	79

Find SAE flange halves in section Eb.

Fittings with standard O-ring seals can be used for temperatures from -30 °C up to +105 °C.

Find O-rings in section E. Special O-rings are available on request.

Approved **fitting series** for hose types:

73 731

## XA Caterpillar® Flange Straight

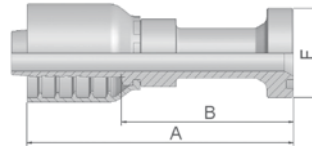

XXXXX-XX-XX Part Number 73	Hose I.D.				Flange	A mm	B mm	F mm
	DN	Inch	Size	mm				
1XA73-12-12	20	3/4	-12	19.1	3/4	123	75	41
1XA73-16-12	20	3/4	-12	19.1	1	134	86	48
1XA73-16-16	25	1	-16	25.4	1	138	88	48

Fittings with standard O-ring seals can be used for temperatures from -30 °C up to +105 °C.  
Find O-rings in section E. Special O-rings are available on request.

## XF Caterpillar® Flange 45° Elbow

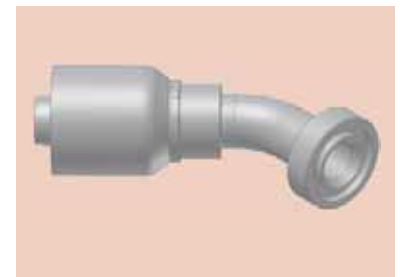
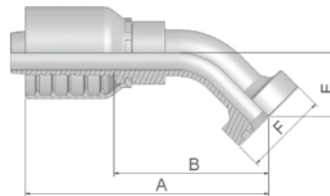

XXXXX-XX-XX Part Number 73	Hose I.D.				Flange	A mm	B mm	E mm	F mm
	DN	Inch	Size	mm					
1XF73-12-12	20	3/4	-12	19.1	3/4	123	75	31	41
1XF73-16-12	20	3/4	-12	19.1	1	122	74	31	48
1XF73-16-16	25	1	-16	25.4	1	139	88	36	48

Fittings with standard O-ring seals can be used for temperatures from -30 °C up to +105 °C.  
Find O-rings in section E. Special O-rings are available on request.

Approved **fitting series** for hose types:

73 731

**XG** Caterpillar® Flange  
60° Elbow

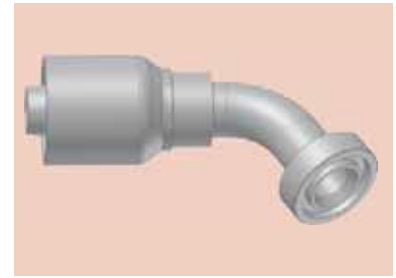
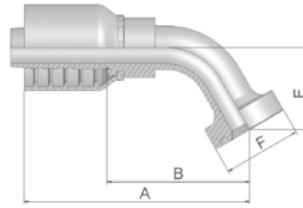

XXXXX-XX-XX Part Number 73	Hose I.D.				Flange	A mm	B mm	E mm	F mm
	DN	Inch	Size	mm					
1XG73-12-12	20	3/4	-12	19.1	3/4	138	90	42	41
1XG73-16-16	25	1	-16	25.4	1	160	109	50	48
1XG73-20-16	25	1	-16	25.4	1-1/4	153	103	48	54

Fittings with standard O-ring seals can be used for temperatures from -30 °C up to +105 °C.  
Find O-rings in section E. Special O-rings are available on request.

**XN** Caterpillar® Flange  
90° Elbow

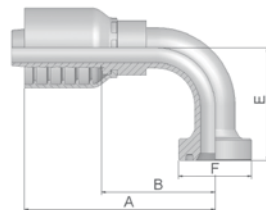

XXXXX-XX-XX Part Number 73	Hose I.D.				Flange	A mm	B mm	E mm	F mm
	DN	Inch	Size	mm					
1XN73-12-12	20	3/4	-12	19.1	3/4	111	63	63	41
1XN73-16-16	25	1	-16	25.4	1	128	78	74	48
1XN73-20-20	32	1-1/4	-20	31.8	1-1/4	172	108	77	54

Fittings with standard O-ring seals can be used for temperatures from -30 °C up to +105 °C.  
Find O-rings in section E. Special O-rings are available on request.

Approved **fitting series** for hose types:

73 731



# JC

## Female ORFS Swivel – Straight Short

ISO 12151-1 – SWSA  
SAE J516 – ORFS

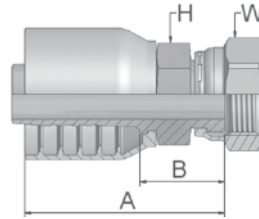

XXXXX-XX-XX Part Number 73	Hose I.D.				Thread UNF	A mm	B mm	H mm	W mm
	DN	Inch	Size	mm					
1JC73-12-12-SM	20	3/4	-12	19.1	1-3/16x12	81	33	30	36
1JC73-16-16-SM	25	1	-16	25.4	1-7/16x12	97	38	36	41
1JC73-20-20-SM	32	1-1/4	-20	31.8	1-11/16x12	106	42	46	50
1JC73-24-24-SM	40	1-1/2	-24	38.1	2x12	117	44	50	60

# JS

## ORFS Swivel Female (Long)

ISO 12151-1-SWSB  
SAE J516 – ORFS

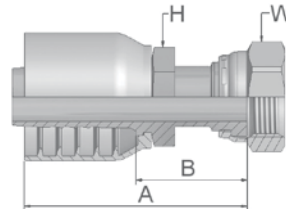

XXXXX-XX-XX Part Number 73	Hose I.D.				Thread UNF	A mm	B mm	H mm Inch	W mm Inch
	DN	Inch	Size	mm					
1JS73-12-12-SM	20	3/4	-12	19.1	1-3/16x12	98	50	30	36
1JS73-16-12-SM	20	3/4	-12	19.1	1-7/16x12	103	58	1-3/8	1-5/8
1JS73-16-16-SM	25	1	-16	25.4	1-7/16x12	103	52	36	41
1JS73-20-16-SM	25	1	-16	25.4	1-11/16x12	114	64	41	50
1JS73-20-20-SM	32	1-1/4	-20	31.8	1-11/16x12	118	54	46	50
1JS73-24-24-SM	40	1-1/2	-24	38.1	2x12	120	57	50	60

Approved fitting series for hose types:



SM: Metric Hexagon

73 731

## J7 Female ORFS – Swivel 45° Elbow

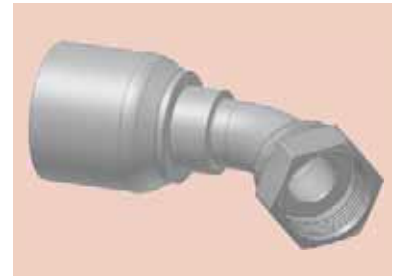
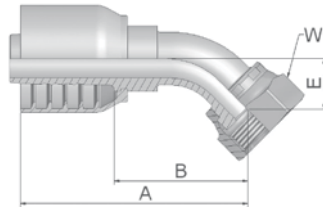
ISO 12151-1 – SWE 45°  
SAE J516 – ORFS 45°





XXXXX-XX-XX Part Number 73	 Hose I.D.				 Thread UNF	A mm	B mm	E mm	 W mm
	DN	Inch	Size	mm					
1J773-12-12-SM	20	3/4	-12	19.1	1-3/16x12	105	57	21	36
1J773-16-12-SM	20	3/4	-12	19.1	1-7/16x12	107	59	24	41
1J773-16-16-SM	25	1	-16	25.4	1-7/16x12	119	69	24	41
1J773-20-16-SM	25	1	-16	25.4	1-11/16x12	131	80	26	50
1J773-20-20-SM	32	1-1/4	-20	31.8	1-11/16x12	154	90	30	50

## J9 Female ORFS – Swivel 90° Elbow – Short Drop

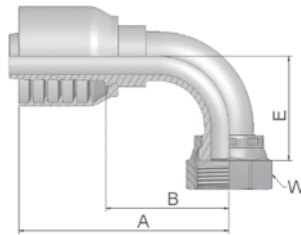
ISO 12151-1 – SWES  
SAE J516 – ORFS 90°



XXXXX-XX-XX Part Number 73	 Hose I.D.				 Thread UNF	A mm	B mm	E mm	 W mm
	DN	Inch	Size	mm					
1J973-12-12-SM	20	3/4	-12	19.1	1-3/16x12	101	53	48	36
1J973-16-12-SM	20	3/4	-12	19.1	1-7/16x12	114	66	56	41
1J973-16-16-SM	25	1	-16	25.4	1-7/16x12	120	70	56	41
1J973-20-16-SM	25	1	-16	25.4	1-11/16x12	127	77	64	50
1J973-20-20-SM	32	1-1/4	-20	31.8	1-11/16x12	151	87	69	50

Approved **fitting series** for hose types:

SM: Metric Hexagon

73 731

**JM**

**ORFS Male**

ISO 12151-1-S – SAE J516

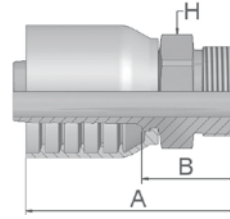

XXXXX-XX-XX Part Number 73	Hose I.D.				Thread UNF	A mm	B mm	H mm
	DN	Inch	Size	mm				
1JM73-16-12-SM	20	3/4	-12	19.1	1-7/16x12	87	39	41
1JM73-16-16-SM	25	1	-16	25.4	1-7/16x12	93	42	41
1JM73-20-16-SM	25	1	-16	25.4	1-11/16x12	89	39	46
1JM73-20-20-SM	32	1-1/4	-20	31.8	1-11/16x12	106	42	46

JM fittings are supplied without O-ring.  
Find O-rings in section E. Special O-rings are available on request.

Approved **fitting series** for hose types:

SM: Metric Hexagon

73 731

## F2 Female French Gas Series Swivel – 90° Elbow

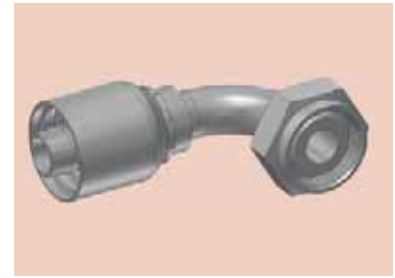
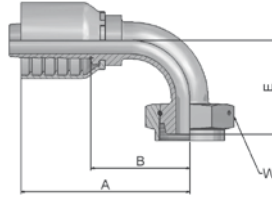

XXXXX-XX-XX Part Number 73	Hose I.D.				Thread metric	A mm	B mm	E mm	W mm
	DN	Inch	Size	mm					
1F273-33-16	25	1	-16	25.4	M45x1.5	122	71	68	55

## F4 Female French Gas Series Swivel – Straight (Ball Nose)

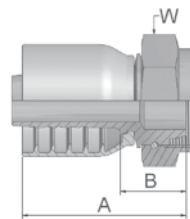

XXXXX-XX-XX Part Number 73	Hose I.D.				Thread metric	Tube O.D. mm	A mm	B mm	W mm
	DN	Inch	Size	mm					
1F473-27-12	20	3/4	-12	19.1	M36x1.5	27	83	33	46
1F473-33-16	25	1	-16	25.4	M45x1.5	33	85	34	55

Approved **fitting series** for hose types:





73 731

# XU

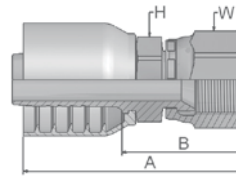
## Female Metric – Swivel Straight (30° Flare)

JIS B8363





XXXXX-XX-XX Part Number 73	 Hose I.D.				 Thread metric	A mm	B mm	 H	 W
	DN	Inch	Size	mm	mm			mm	mm
1XU73-12-12	20	3/4	-12	19.1	M30x1.5	76	28	32	36
1XU73-16-16	25	1	-16	25.4	M33x1.5	85	35	36	41

Approved **fitting series** for hose types:

**73** 731

## Flange

Page De-1		
<b>8A</b> De-1  Flange – Straight 8000 psi	<b>8F</b> De-1  Flange – 45° Elbow 8000 psi	<b>8N</b> De-1  Flange – 90° Elbow 8000 psi

## 8A Flange – Straight

8000 psi

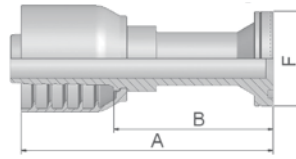

XXXXX-XX-XX Part Number 76	Hose I.D.				Flange	A mm	B mm	F mm
	DN	Inch	Size	mm				
18A76-12-12	20	3/4	-12	19.1	3/4	134	75	41
18A76-16-16	25	1	-16	25.4	1	145	81	48

## 8F Flange – 45° Elbow

8000 psi

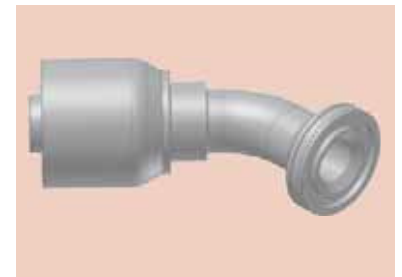
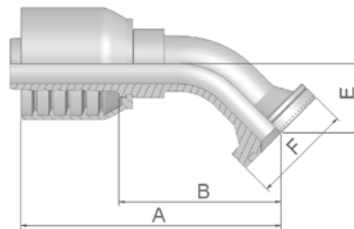

XXXXX-XX-XX Part Number 76	Hose I.D.				Flange	A mm	B mm	E mm	F mm
	DN	Inch	Size	mm					
18F76-12-12	20	3/4	-12	19.1	3/4	126	67	26	41
18F76-16-16	25	1	-16	25.4	1	155	90	32	48

## 8N Flange – 90° Elbow

8000 psi

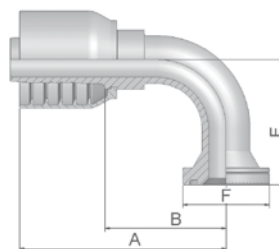





XXXXX-XX-XX Part Number 76	Hose I.D.				Flange	A mm	B mm	E mm	F mm
	DN	Inch	Size	mm					
18N76-12-12	20	3/4	-12	19.1	3/4	122	63	70	41
18N76-16-16	25	1	-16	25.4	1	150	85	70	48







Approved **fitting series** for hose types:

76 761

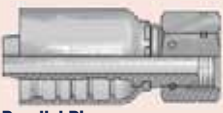

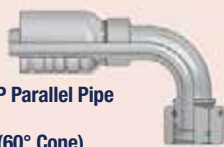
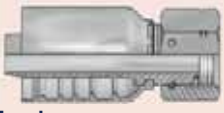

## DIN – Metric

Page Df-1 – Df-2			
<p><b>C9</b> Df-1</p>  <p>Female Metric 24° – Swivel Heavy Series with O-Ring Straight ISO 12151-2-SWS-S – DKOS</p>	<p><b>0C</b> Df-1</p>  <p>Female Metric 24° – Swivel Heavy Series with O-Ring 45° Elbow ISO 12151-2 – SWE 45°-S – DKOS 45°</p>	<p><b>1C</b> Df-2</p>  <p>Female Metric 24° – Swivel Heavy Series with O-Ring 90° Elbow ISO 12151-2-SWE-S – DKOS 90°</p>	<p><b>D2</b> Df-2</p>  <p>Male Metric 24° – Rigid Heavy Series – Straight ISO 12151-2-S-S – CES</p>

## BSP

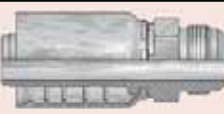









Page Df-3 – Df-6			
<p><b>92</b> Df-3</p>  <p>Female BSP Parallel Pipe Swivel – Straight (60° Cone) BS5200-A – DKR</p>	<p><b>B1</b> Df-3</p>  <p>Female BSP Parallel Pipe Swivel 45° Elbow (60° Cone) BS 5200-D – DKR 45°</p>	<p><b>B2</b> Df-4</p>  <p>Female BSP Parallel Pipe Swivel 90° Elbow (60° Cone) BS 5200-B – DKR 90°</p>	<p><b>EA</b> Df-4</p>  <p>BSP Swivel Female with O-Ring (60° Cone) BS 5200 – ISO 12151-6 – DKOR</p>
<p><b>EB</b> Df-5</p>  <p>BSP Swivel Female with O-Ring 45° Elbow (60° Cone) BS 5200 – ISO 12151-6 – DKOR 45°</p>	<p><b>EC</b> Df-5</p>  <p>BSP Swivel Female with O-Ring 90° Elbow (60° Cone) BS 5200 – ISO 12151-6 – DKOR 90°</p>	<p><b>D9</b> Df-6</p>  <p>Male BSP Parallel Pipe Rigid – Straight (60° Cone) BS5200 – AGR</p>	

## SAE





Page Df-7 – Df-9			
<p><b>01</b> Df-7</p>  <p>Male NPTF Pipe Rigid – Straight SAE J476A / J516 – AGN</p>	<p><b>03</b> Df-7</p>  <p>Male JIC 37° – Rigid Straight ISO12151-5-S – AGJ</p>	<p><b>06</b> Df-8</p>  <p>Female JIC 37° – Swivel Straight ISO12151-5-SWS – DKJ</p>	<p><b>37</b> Df-8</p>  <p>Female JIC 37° – Swivel 45° Elbow ISO 12151-5-SWE 45° – DKJ 45°</p>
<p><b>39</b> Df-9</p>  <p>Female JIC 37° – Swivel 90° Elbow ISO 12151-5-SWES – DKJ 90°</p>			



## Flange

Page Df-10 – Df-14			
<p><b>15/4A</b> Df-10</p>  <p>SAE Code 61 Flange Straight ISO 12151-3-S-L – SFL 5000 psi</p>	<p><b>17/4F</b> Df-10</p>  <p>SAE Code 61 Flange 45° Elbow ISO 12151-3 – E45S – L – SFL 45° 5000 psi</p>	<p><b>19/4N</b> Df-11</p>  <p>SAE Code 61 Flange 90° Elbow ISO 12151-3-E-L – SFL 90° 5000 psi</p>	<p><b>6A</b> Df-11</p>  <p>SAE Code 62 Flange Straight ISO 12151-3-S-S – SFS 6000 psi</p>
<p><b>6E</b> Df-12</p>  <p>SAE Code 62 Flange 30° Elbow SFS 30°</p>	<p><b>6F</b> Df-12</p>  <p>SAE Code 62 Flange 45° Elbow – Heavy Series ISO 12151-3 – E45-S – SFS 45° 6000 psi</p>	<p><b>6N</b> Df-13</p>  <p>SAE Code 62 Flange 90° Elbow ISO 12151-3 – E-S – SFS 90° 6000 psi</p>	<p><b>X5</b> Df-13</p>  <p>Flange – Straight Full flange system for Code 61 or Code 62</p>
<p><b>X7</b> Df-14</p>  <p>Flange – 45° Elbow Full flange system for Code 61 or Code 62</p>	<p><b>X9</b> Df-14</p>  <p>Flange – 90° Elbow Full flange system for Code 61 or Code 62</p>		

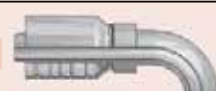
## ORFS

Page Df-15 – Df-16			
<p><b>JC</b> Df-15</p>  <p>Female ORFS Swivel – Straight Short ISO 12151-1 – SWSA SAE J516 – ORFS</p>	<p><b>J7</b> Df-15</p>  <p>Female ORFS – Swivel 45° Elbow ISO 12151-1 – SWE 45° SAE J516 – ORFS 45°</p>	<p><b>J9</b> Df-16</p>  <p>Female ORFS – Swivel 90° Elbow – Short Drop ISO 12151-1 – SWES SAE J516 – ORFS 90°</p>	<p><b>JM</b> Df-16</p>  <p>ORFS Male ISO 12151-1-S – SAE J516</p>



## C9 Female Metric 24° – Swivel Heavy Series with O-Ring Straight

ISO 12151-2-SWS-S – DKOS

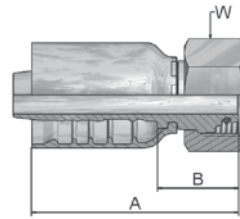

XXXXX-XX-XX Part Number 77	Hose I.D.				Thread metric	A mm	B mm	W mm
	DN	Inch	Size	mm				
1C977-16-8	12	1/2	-8	12.7	M24x1.5	60	25	30
1C977-20-10	16	5/8	-10	15.9	M30x2	67	28	36
1C977-16-10	16	5/8	-10	15.9	M24x1.5	67	28	30
1C977-20-12	20	3/4	-12	19.1	M30x2	76	30	36
1C977-25-12	20	3/4	-12	19.1	M36x2	77	31	46
1C977-30-16	25	1	-16	25.4	M42x2	89	35	50
1C977-38-20	32	1-1/4	-20	31.8	M52x2	100	36	60

Fittings with standard O-ring seals can be used for temperatures from -30 °C up to +105 °C.  
Find O-rings in section E. Special O-rings are available on request.

## OC Female Metric 24° – Swivel Heavy Series with O-Ring 45° Elbow

ISO 12151-2 – SWE 45°-S – DKOS 45°

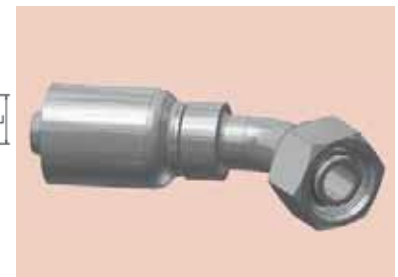
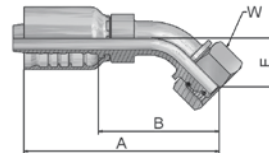

XXXXX-XX-XX Part Number 77	Hose I.D.				Thread metric	A mm	B mm	E mm	W mm
	DN	Inch	Size	mm					
10C77-16-8	12	1/2	-8	12.7	M24x1.5	83	49	24	30
10C77-20-10	16	5/8	-10	15.9	M30x2	107	68	28	36
10C77-20-12	20	3/4	-12	19.1	M30x2	120	74	30	36
10C77-25-12	20	3/4	-12	19.1	M36x2	119	73	29	46
10C77-30-16	25	1	-16	25.4	M42x2	142	88	33	50
10C77-38-20	32	1-1/4	-20	31.8	M52x2	161	97	37	60

Fittings with standard O-ring seals can be used for temperatures from -30 °C up to +105 °C.  
Find O-rings in section E. Special O-rings are available on request.

Approved **fitting series** for hose types:

77 787TC 797TC

## 1C Female Metric 24° – Swivel Heavy Series with O-Ring 90° Elbow

ISO 12151-2-SWE-S – DKOS 90°

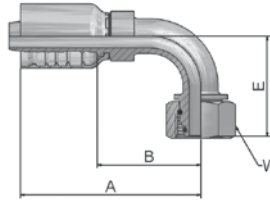

XXXXX-XX-XX Part Number 77	Hose I.D.				Thread metric	A mm	B mm	E mm	W mm
	DN	Inch	Size	mm					
11C77-16-8	12	1/2	-8	12.7	M24x1.5	77	42	45	30
11C77-20-10	16	5/8	-10	15.9	M30x2	92	53	53	36
11C77-20-12	20	3/4	-12	19.1	M30x2	108	62	60	36
11C77-25-12	20	3/4	-12	19.1	M36x2	108	62	59	46
11C77-30-16	25	1	-16	25.4	M42x2	131	77	69	50
11C77-38-20	32	1-1/4	-20	31.8	M52x2	151	87	78	60

Fittings with standard O-ring seals can be used for temperatures from -30 °C up to +105 °C.  
Find O-rings in section E. Special O-rings are available on request.

## D2 Male Metric 24° – Rigid Heavy Series – Straight

ISO 12151-2-S-S – CES

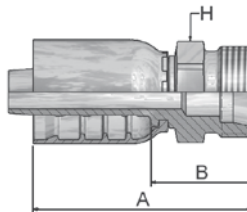

XXXXX-XX-XX Part Number 77	Hose I.D.				Thread metric	A mm	B mm	H mm
	DN	Inch	Size	mm				
1D277-16-8	12	1/2	-8	12.7	M24x1.5	64	30	24
1D277-20-10	16	5/8	-10	15.9	M30x2	72	34	30
1D277-20-12	20	3/4	-12	19.1	M30x2	84	38	30
1D277-25-12	20	3/4	-12	19.1	M36x2	86	40	36
1D277-30-16	25	1	-16	25.4	M42x2	99	45	46
1D277-38-20	32	1-1/4	-20	31.8	M52x2	114	51	55

Approved **fitting series** for hose types:

77 787TC 797TC

## 92 Female BSP Parallel Pipe Swivel – Straight (60° Cone)

BS5200-A – DKR

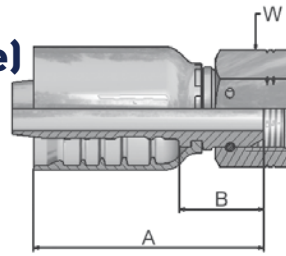

XXXXX-XX-XX Part Number 77	Hose I.D.				Thread BSP	A mm	B mm	W mm
	DN	Inch	Size	mm				
19277-8-8	12	1/2	-8	12.7	1/2x14	57	23	27
19277-12-12	20	3/4	-12	19.1	3/4x14	73	27	32
19277-16-16	25	1	-16	25.4	1x11	91	37	41
19277-12-16	25	1	-16	25.4	3/4x14	83	29	32

## B1 Female BSP Parallel Pipe Swivel 45° Elbow (60° Cone)

BS 5200-D – DKR 45°

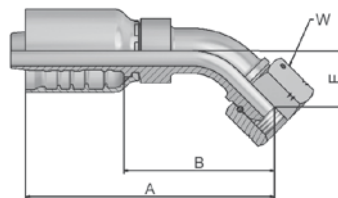

XXXXX-XX-XX Part Number 77	Hose I.D.				Thread BSP	A mm	B mm	E mm	W mm
	DN	Inch	Size	mm					
1B177-8-8	12	1/2	-8	12.7	1/2x14	84	49	20	27
1B177-12-12	20	3/4	-12	19.1	3/4x14	116	70	26	32
1B177-16-12	20	3/4	-12	19.1	1x11	124	78	34	41
1B177-16-16	25	1	-16	25.4	1x11	145	91	36	41

Approved **fitting series** for hose types:

77 787TC 797TC

## B2 Female BSP Parallel Pipe Swivel 90° Elbow (60° Cone)

BS 5200-B – DKR 90°

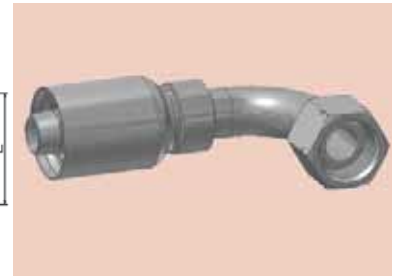
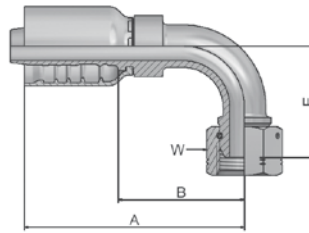

XXXXX-XX-XX Part Number 77	Hose I.D.				Thread BSP	A mm	B mm	E mm	W mm
	DN	Inch	Size	mm					
1B277-8-8	12	1/2	-8	12.7	1/2x14	76	41	40	27
1B277-12-12	20	3/4	-12	19.1	3/4x14	108	62	55	32
1B277-16-16	25	1	-16	25.4	1x11	131	77	74	41

## EA BSP Swivel Female with O-Ring (60° Cone)

BS 5200 – ISO 12151-6 – DKOR

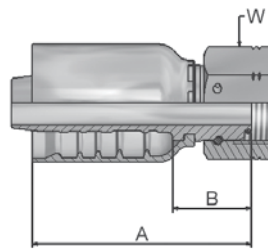

XXXXX-XX-XX Part Number 77	Hose I.D.				Thread BSP	A mm	B mm	W mm
	DN	Inch	Size	mm				
1EA77-8-8	12	1/2	-8	12.7	1/2x14	58	23	27
1EA77-10-10	16	5/8	-10	15.9	5/8x14	62	23	30
1EA77-12-10	16	5/8	-10	15.9	3/4x14	63	24	32
1EA77-12-12	20	3/4	-12	19.1	3/4x14	72	26	32
1EA77-16-16	25	1	-16	25.4	1x11	90	36	41
1EA77-12-16	25	1	-16	25.4	3/4x14	83	29	32
1EA77-20-20	32	1-1/4	-20	31.8	1-1/4x11	96	33	50

Approved **fitting series** for hose types:

77 787TC 797TC

**EB** **BSP Swivel Female  
with O-Ring  
45° Elbow (60° Cone)**

BS 5200 – ISO 12151-6 – DKOR 45°

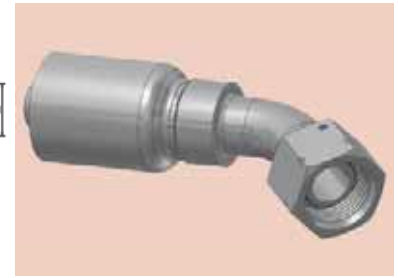
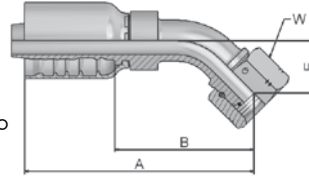

XXXXX-XX-XX Part Number 77	Hose I.D.				Thread BSP	A mm	B mm	E mm	W mm
	DN	Inch	Size	mm					
1EB77-8-8	12	1/2	-8	12.7	1/2x14	80	45	20	27
1EB77-10-10	16	5/8	-10	15.9	5/8x14	101	62	22	30
1EB77-12-10	16	5/8	-10	15.9	3/4x14	103	64	24	32
1EB77-12-12	20	3/4	-12	19.1	3/4x14	117	71	27	32
1EB77-16-16	25	1	-16	25.4	1x11	144	90	35	41
1EB77-20-20	32	1-1/4	-20	31.8	1-1/4x11	159	95	35	50

**EC** **BSP Swivel Female  
with O-Ring  
90° Elbow (60° Cone)**

BS 5200 – ISO 12151-6 – DKOR 90°

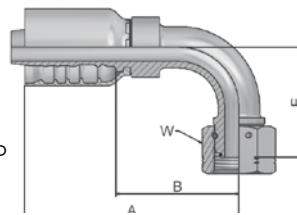

XXXXX-XX-XX Part Number 77	Hose I.D.				Thread BSP	A mm	B mm	E mm	W mm
	DN	Inch	Size	mm					
1EC77-8-8	12	1/2	-8	12.7	1/2x14	76	41	40	27
1EC77-10-10	16	5/8	-10	15.9	5/8x14	92	53	44	30
1EC77-12-10	16	5/8	-10	15.9	3/4x14	92	53	47	32
1EC77-12-12	20	3/4	-12	19.1	3/4x14	108	62	55	32
1EC77-16-16	25	1	-16	25.4	1x11	131	77	72	41
1EC77-20-20	32	1-1/4	-20	31.8	1-1/4x11	151	87	75	50

Approved **fitting series** for hose types:

77 787TC 797TC

## D9 Male BSP Parallel Pipe Rigid – Straight (60° Cone)

BS5200 – AGR

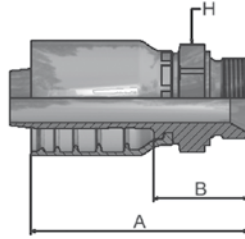

XXXXX-XX-XX Part Number 77	Hose I.D.				Thread BSP	A mm	B mm	H mm
	DN	Inch	Size	mm				
1D977-20-20	32	1-1/4	-20	31.8	1-1/4x11	113	50	50

Approved **fitting series** for hose types:

77 787TC 797TC



# 01

## Male NPTF Pipe Rigid – Straight

SAE J476A / J516 – AGN

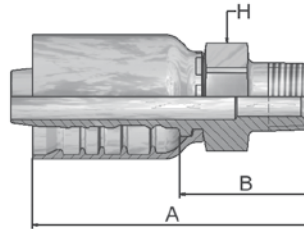

XXXXX-XX-XX Part Number 77	Hose I.D.				Thread NPTF	A mm	B mm	H mm
	DN	Inch	Size	mm				
10177-8-8	12	1/2	-8	12.7	1/2x14	69	35	22
10177-8-12	20	3/4	-12	19.1	1/2x14	87	41	30
10177-12-12	20	3/4	-12	19.1	3/4x14	87	41	30
10177-16-16	25	1	-16	25.4	1x11-1/2	103	49	36
10177-20-20	32	1-1/4	-20	31.8	1-1/4x11	116	53	46

# 03

## Male JIC 37° – Rigid Straight

ISO12151-5-S – AGJ

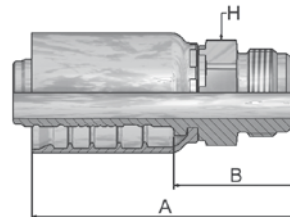

XXXXX-XX-XX Part Number 77	Hose I.D.				Thread UNF	A mm	B mm	H mm
	DN	Inch	Size	mm				
10377-8-8	12	1/2	-8	12,7	3/4x16	66	32	22
10377-10-8	12	1/2	-8	12,7	7/8x14	69	34	24
10377-12-12	20	3/4	-12	19,1	1-1/16x12	89	43	30
10377-16-16	25	1	-16	25,4	1-5/16x12	101	47	36
10377-20-20	32	1-1/4	-20	31,8	1-5/8x12	118	55	50

Approved **fitting series** for hose types:

77 787TC 797TC

## 06 Female JIC 37° – Swivel Straight

ISO12151-5-SWS – DKJ

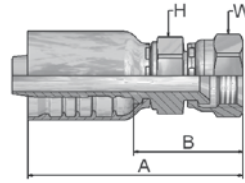

XXXXX-XX-XX Part Number 77	Hose I.D.				Thread UNF	A mm	B mm	H mm	W mm
	DN	Inch	Size	mm					
10677-8-8	12	1/2	-8	12.7	3/4x16	71	37	22	22
10677-10-8	12	1/2	-8	12.7	7/8x14	74	39	22	27
10677-10-10	16	5/8	-10	15.9	7/8x14	81	42	24	27
10677-12-10	16	5/8	-10	15.9	1-1/16x12	84	45	30	32
10677-12-12	20	3/4	-12	19.1	1-1/16x12	94	48	30	32
10677-16-12	20	3/4	-12	19.1	1-5/16x12	99	53	36	41
10677-16-16	25	1	-16	25.4	1-5/16x12	106	52	36	41
10677-20-16	25	1	-16	25.4	1-5/8x12	109	55	41	50
10677-20-20	32	1-1/4	-20	31.8	1-5/8-12	124	60	46	50

## 37 Female JIC 37° – Swivel 45° Elbow

ISO 12151-5-SWE 45° – DKJ 45°

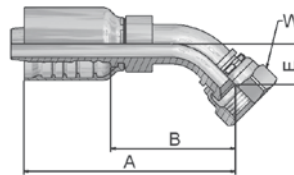

XXXXX-XX-XX Part Number 77	Hose I.D.				Thread UNF	A mm	B mm	E mm	W mm
	DN	Inch	Size	mm					
13777-8-8	12	1/2	-8	12.7	3/4x16	73	38	15	22
13777-10-8	12	1/2	-8	12.7	7/4x14	76	41	16	27
13777-12-10	16	5/8	-10	15.9	1-1/16x12	98	59	21	32
13777-10-10	16	5/8	-10	15.9	7/4x14	93	54	16	27
13777-12-12	20	3/4	-12	19.1	1-1/16x12	111	65	21	32
13777-16-16	25	1	-16	25.4	1-5/16x12	133	79	24	41
13777-20-20	32	1-1/4	-20	31.8	1-5/8x12	153	90	32	50

Approved **fitting series** for hose types:

77 787TC 797TC

# 39 Female JIC 37° – Swivel 90° Elbow

ISO 12151-5-SWES – DKJ 90°

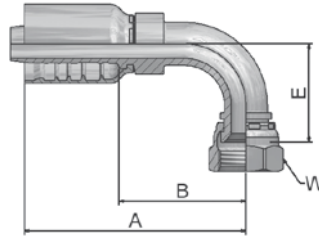

XXXXX-XX-XX Part Number 77	Hose I.D.				Thread UNF	A mm	B mm	E mm	W mm
	DN	Inch	Size	mm					
13977-8-8	12	1/2	-8	12.7	3/4x16	71	36	29	22
13977-10-8	12	1/2	-8	12.7	7/4x14	76	41	32	27
13977-12-10	16	5/8	-10	15.9	1-1/16x12	97	50	58	32
13977-12-12	20	3/4	-12	19.1	1-1/16x12	108	62	48	32
13977-16-12	20	3/4	-12	19.1	1-5/16x12	108	62	56	41
13977-16-16	25	1	-16	25.4	1-5/16x12	131	77	74	41
13977-20-20	32	1-1/4	-20	31.8	1-5/8x12	148	84	78	50

Approved **fitting series** for hose types:

77 787TC 797TC

## 15/4A SAE Code 61 Flange Straight

ISO 12151-3-S-L – SFL  
5000 psi

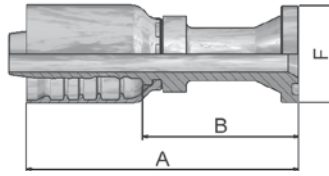

XXXXX-XX-XX Part Number 77	Hose I.D.				Flange	A mm	B mm	F mm
	DN	Inch	Size	mm				
11577-8-8	12	1/2	-8	12.7	1/2	90	55	30
11577-12-8	12	1/2	-8	12.7	3/4	67	33	38
11577-12-12	20	3/4	-12	19.1	3/4	107	62	38
11577-16-12	20	3/4	-12	19.1	1	88	42	45
11577-16-16	25	1	-16	25.4	1	119	65	45
14A77-20-16	25	1	-16	25.4	1-1/4	87	33	51
14A77-20-20	32	1-1/4	-20	31.8	1-1/4	138	74	51
14A77-24-20	32	1-1/4	-20	31.8	1-1/2	100	37	60

Find SAE flange halves in section Eb.

Fittings with standard O-ring seals can be used for temperatures from -30 °C up to +105 °C.

Find O-rings in section E. Special O-rings are available on request.

## 17/4F SAE Code 61 Flange 45° Elbow

ISO 12151-3 – E45S – L – SFL 45°  
5000 psi

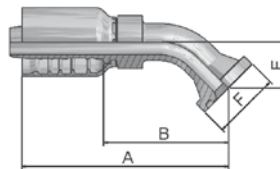

XXXXX-XX-XX Part Number 77	Hose I.D.				Flange	A mm	B mm	E mm	F mm
	DN	Inch	Size	mm					
11777-8-8	12	1/2	-8	12.7	1/2	79	45	20	30
11777-12-8	12	1/2	-8	12.7	3/4	81	47	22	38
11777-12-12	20	3/4	-12	19.1	3/4	116	70	26	38
11777-16-12	20	3/4	-12	19.1	1	116	70	26	45
11777-16-16	25	1	-16	25.4	1	141	87	32	45
14F77-20-16	25	1	-16	25.4	1-1/4	141	87	32	51
14F77-20-20	32	1-1/4	-20	31.8	1-1/4	162	99	38	51
14F77-24-20	32	1-1/4	-20	31.8	1-1/2	162	99	38	60

Find SAE flange halves in section Eb.

Fittings with standard O-ring seals can be used for temperatures from -30 °C up to +105 °C.

Find O-rings in section E. Special O-rings are available on request.

Approved **fitting series** for hose types:

77 787TC 797TC

# 19/4N SAE Code 61 Flange 90° Elbow

ISO 12151-3-E-L – SFL 90°  
5000 psi

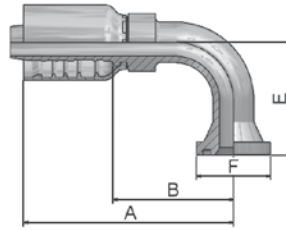

XXXXX-XX-XX Part Number 77	Hose I.D.				Flange	A mm	B mm	E mm	F mm
	DN	Inch	Size	mm					
11977-8-8	12	1/2	-8	12.7	1/2	76	41	41	30
11977-12-8	12	1/2	-8	12.7	3/4	80	45	42	38
11977-12-12	20	3/4	-12	19.1	3/4	108	62	58	38
11977-16-12	20	3/4	-12	19.1	1	108	62	58	45
11977-16-16	25	1	-16	25.4	1	131	77	70	45
14N77-20-16	25	1	-16	25.4	1-1/4	131	77	69	51
14N77-20-20	32	1-1/4	-20	31.8	1-1/4	151	87	90	51
14N77-24-20	32	1-1/4	-20	31.8	1-1/2	151	87	90	60

Find SAE flange halves in section Eb.  
Fittings with standard O-ring seals can be used for temperatures from -30 °C up to +105 °C.  
Find O-rings in section E. Special O-rings are available on request.

# 6A SAE Code 62 Flange Straight

ISO 12151-3-S-S – SFS  
6000 psi

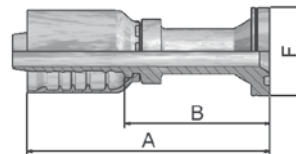

XXXXX-XX-XX Part Number 77	Hose I.D.				Flange	A mm	B mm	F mm
	DN	Inch	Size	mm				
16A77-8-8	12	1/2	-8	12.7	1/2	90	55	32
16A77-12-8	12	1/2	-8	12.7	3/4	69	35	41
16A77-12-10	16	5/8	-10	15.9	3/4	75	36	41
16A77-12-12	20	3/4	-12	19.1	3/4	114	68	41
16A77-16-12	20	3/4	-12	19.1	1	88	42	48
16A77-16-16	25	1	-16	25.4	1	134	80	48
16A77-20-16	25	1	-16	25.4	1-1/4	103	49	54
16A77-16-20	32	1-1/4	-20	31.8	1	145	82	48
16A77-20-20	32	1-1/4	-20	31.8	1-1/4	146	82	54
16A77-24-20	32	1-1/4	-20	31.8	1-1/2	118	55	64

Find SAE flange halves in section Eb.  
Fittings with standard O-ring seals can be used for temperatures from -30 °C up to +105 °C.  
Find O-rings in section E. Special O-rings are available on request.

Approved fitting series for hose types:

77 787TC 797TC

## 6E SAE Code 62 Flange 30° Elbow

SFS 30°

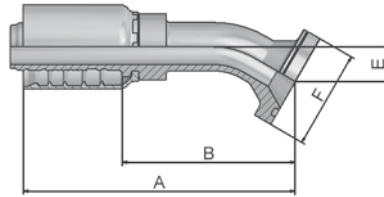

XXXXX-XX-XX Part Number 77	Hose I.D.				Flange	A mm	B mm	E mm	F mm
	DN	Inch	Size	mm					
16E77-20-16	25	1	-16	25.4	1-1/4	149	95	19	54

Find SAE flange halves in section Eb.

Fittings with standard O-ring seals can be used for temperatures from -30 °C up to +105 °C.

Find O-rings in section E. Special O-rings are available on request.

## 6F SAE Code 62 Flange 45° Elbow – Heavy Series

ISO 12151-3 – E45-S – SFS 45°  
6000 psi

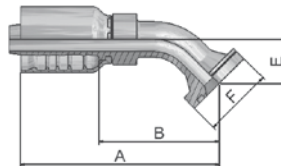

XXXXX-XX-XX Part Number 77	Hose I.D.				Flange	A mm	B mm	E mm	F mm
	DN	Inch	Size	mm					
16F77-8-8	12	1/2	-8	12.7	1/2	79	44	19	32
16F77-12-8	12	1/2	-8	12.7	3/4	86	51	26	41
16F77-12-12	20	3/4	-12	19.1	3/4	116	70	26	41
16F77-16-12	20	3/4	-12	19.1	1	116	70	26	48
16F77-16-16	25	1	-16	25.4	1	141	87	32	48
16F77-20-16	25	1	-16	25.4	1-1/4	142	88	32	54
16F77-16-20	32	1-1/4	-20	31.8	1	159	95	38	48
16F77-20-20	32	1-1/4	-20	31.8	1-1/4	162	99	38	54
16F77-24-20	32	1-1/4	-20	31.8	1-1/2	162	99	38	64

Find SAE flange halves in section Eb.

Fittings with standard O-ring seals can be used for temperatures from -30 °C up to +105 °C.

Find O-rings in section E. Special O-rings are available on request.

Approved **fitting series** for hose types:

77 787TC 797TC

# 6N

## SAE Code 62 Flange 90° Elbow

ISO 12151-3 – E-S – SFS 90°  
6000 psi

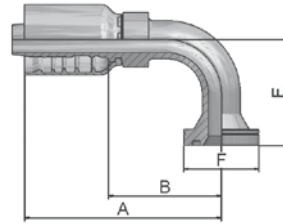

XXXXX-XX-XX Part Number 77	Hose I.D.				Flange	A mm	B mm	E mm	F mm
	DN	Inch	Size	mm					
16N77-8-8	12	1/2	-8	12.7	1/2	77	42	41	32
16N77-12-8	12	1/2	-8	12.7	3/4	81	47	45	41
16N77-12-10	16	5/8	-10	15.9	3/4	92	53	54	41
16N77-12-12	20	3/4	-12	19.1	3/4	108	62	58	41
16N77-16-12	20	3/4	-12	19.1	1	108	62	58	48
16N77-16-16	25	1	-16	25.4	1	131	77	70	48
16N77-20-16	25	1	-16	25.4	1-1/4	135	81	70	54
16N77-16-20	32	1-1/4	-20	31.8	1	145	82	90	48
16N77-20-20	32	1-1/4	-20	31.8	1-1/4	151	87	90	54
16N77-24-20	32	1-1/4	-20	31.8	1-1/2	151	87	90	64

Find SAE flange halves in section Eb.  
Fittings with standard O-ring seals can be used for temperatures from -30 °C up to +105 °C.  
Find O-rings in section E. Special O-rings are available on request.

# X5

## Flange – Straight

Full flange system for  
Code 61 or Code 62

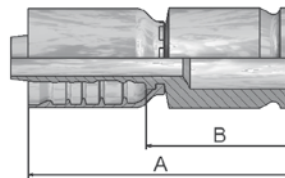

XXXXX-XX-XX Part Number 77	Hose I.D.				A mm	B mm
	DN	Inch	Size	mm		
1X577-12-12	20	3/4	-12	19.1	103	57
1X577-16-12	20	3/4	-12	19.1	103	57
1X577-16-16	25	1	-16	25.4	113	59
1X577-20-16	25	1	-16	25.4	113	59
1X577-24-16	25	1	-16	25.4	113	59

Find full flange system on page Eb-2.

Approved fitting series for hose types:

77 787TC 797TC

## X7 Flange - 45° Elbow

Full flange system for  
Code 61 or Code 62

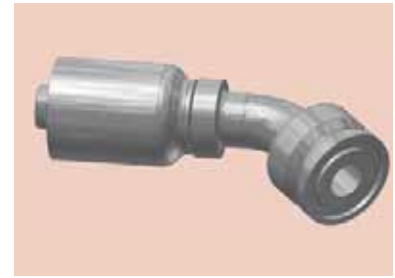
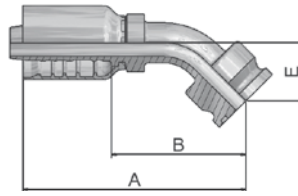

XXXXX-XX-XX Part Number 77	Hose I.D.				A mm	B mm	E mm
	DN	Inch	Size	mm			
1X777-12-12	20	3/4	-12	19.1	118	73	29
1X777-16-12	20	3/4	-12	19.1	118	72	29
1X777-16-16	25	1	-16	25.4	141	87	32
1X777-20-16	25	1	-16	25.4	147	93	38

Find full flange system on page Eb-2.

## X9 Flange - 90° Elbow

Full flange system for  
Code 61 or Code 62

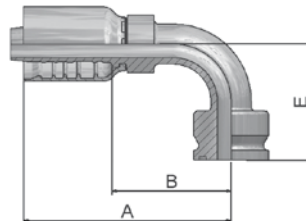

XXXXX-XX-XX Part Number 77	Hose I.D.				A mm	B mm	E mm
	DN	Inch	Size	mm			
1X977-12-12	20	3/4	-12	19.1	108	62	61
1X977-16-12	20	3/4	-12	19.1	108	62	61
1X977-16-16	25	1	-16	25.4	131	77	70
1X977-20-16	25	1	-16	25.4	131	77	70

Find full flange system on page Eb-2.

Approved **fitting series** for hose types:

77 787TC 797TC



# JC

## Female ORFS Swivel – Straight Short

ISO 12151-1 – SWSA  
SAE J516 – ORFS

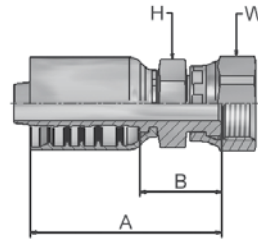

XXXXX-XX-XX Part Number 77	Hose I.D.				Thread UNF	A mm	B mm	H mm	W mm
	DN	Inch	Size	mm					
1JC77-8-8	12	1/2	-8	12.7	13/16x16	60	25	22	24
1JC77-12-8	12	1/2	-8	12.7	1-3/16x12	64	29	30	36
1JC77-10-10	16	5/8	-10	15.9	1x14	70	31	24	30
1JC77-12-10	16	5/8	-10	15.9	13/16x16	69	30	30	36
1JC77-10-12	20	3/4	-12	19.1	1x14	79	33	30	30
1JC77-12-12	20	3/4	-12	19.1	1-3/16x12	79	33	30	36
1JC77-16-12	20	3/4	-12	19.1	1-7/16x12	81	35	36	41
1JC77-12-16	25	1	-16	25.4	1-3/16x12	92	38	36	36
1JC77-16-16	25	1	-16	25.4	1-7/16x12	91	37	36	41
1JC77-20-16	25	1	-16	25.4	1-11/16x12	90	36	41	50

# J7

## Female ORFS – Swivel 45° Elbow

ISO 12151-1 – SWE 45°  
SAE J516 – ORFS 45°

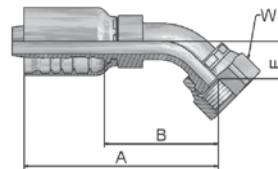

XXXXX-XX-XX Part Number 77	Hose I.D.				Thread UNF	A mm	B mm	E mm	W mm
	DN	Inch	Size	mm					
1J777-8-8	12	1/2	-8	12.7	13/16x16	73	38	15	24
1J777-12-12	20	3/4	-12	19.1	1-3/16x12	111	65	21	36
1J777-16-16	25	1	-16	25.4	1-7/16x12	133	79	24	41

Approved fitting series for hose types:

77 787TC 797TC

## J9 Female ORFS – Swivel 90° Elbow – Short Drop

ISO 12151-1 – SWES  
SAE J516 – ORFS 90°

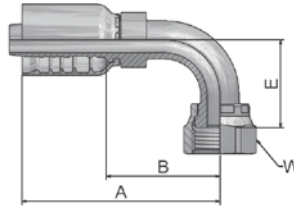

XXXXX-XX-XX Part Number 77	Hose I.D.				Thread UNF	A mm	B mm	E mm	W mm
	DN	Inch	Size	mm					
1J977-8-8	12	1/2	-8	12.7	13/16x16	71	36	29	24
1J977-12-12	20	3/4	-12	19.1	1-3/16x12	108	62	48	36
1J977-16-12	20	3/4	-12	19.1	1-7/16x12	108	62	56	41
1J977-16-16	25	1	-16	25.4	1-7/16x12	131	77	56	41

## JM ORFS Male

ISO 12151-1-S – SAE J516

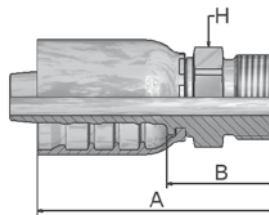

XXXXX-XX-XX Part Number 77	Hose I.D.				Thread UNF	A mm	B mm	H mm
	DN	Inch	Size	mm				
1JM77-8-8	12	1/2	-8	12.7	13/16x16	63	28	22
1JM77-12-8	12	1/2	-8	12.7	1-3/16x12	70	35	32
1JM77-10-10	16	5/8	-10	15.9	1x14	72	33	27
1JM77-12-12	20	3/4	-12	19.1	1-3/16x12	83	37	32
1JM77-16-12	20	3/4	-12	19.1	1-7/16x12	84	38	41
1JM77-16-16	25	1	-16	25.4	1-7/16x12	96	41	41
1JM77-20-16	25	1	-16	25.4	1-11/16x12	93	39	46





JM fittings are supplied without O-ring.  
Find O-rings in section E. Special O-rings are available on request.

Approved **fitting series** for hose types:





77 787TC 797TC







## DIN – Metric

Page Dg-1 – Dg-2			
<p><b>C9</b> Dg-1</p>  <p>Female Metric 24° – Swivel Heavy Series with O-Ring Straight ISO 12151-2-SWS-S – DKOS</p>	<p><b>0C</b> Dg-1</p>  <p>Female Metric 24° – Swivel Heavy Series with O-Ring 45° Elbow ISO 12151-2 – SWE 45°-S – DKOS 45°</p>	<p><b>1C</b> Dg-2</p>  <p>Female Metric 24° – Swivel Heavy Series with O-Ring 90° Elbow ISO 12151-2-SWE-S – DKOS 90°</p>	<p><b>D2</b> Dg-2</p>  <p>Male Metric 24° – Rigid Heavy Series – Straight ISO 12151-2-S-S – CES</p>











## BSP

Page Dg-3 – Dg-4			
<p><b>92</b> Dg-3</p>  <p>Female BSP Parallel Pipe Swivel – Straight (60° Cone) BS5200-A – DKR</p>	<p><b>B1</b> Dg-3</p>  <p>Female BSP Parallel Pipe Swivel 45° Elbow (60° Cone) BS 5200-D – DKR 45°</p>	<p><b>B2</b> Dg-4</p>  <p>Female BSP Parallel Pipe Swivel 90° Elbow (60° Cone) BS 5200-B – DKR 90°</p>	<p><b>D9</b> Dg-4</p>  <p>Male BSP Parallel Pipe Rigid – Straight (60° Cone) BS5200 – AGR</p>





## SAE

Page Dg-5 – Dg-7			
<p><b>01</b> Dg-5</p>  <p>Male NPTF Pipe Rigid – Straight SAE J476A / J516 – AGN</p>	<p><b>03</b> Dg-5</p>  <p>Male JIC 37° – Rigid Straight ISO12151-5-S – AGJ</p>	<p><b>06</b> Dg-6</p>  <p>Female JIC 37° – Swivel Straight ISO12151-5-SWS – DKJ</p>	<p><b>37</b> Dg-6</p>  <p>Female JIC 37° – Swivel 45° Elbow ISO 12151-5-SWE 45° – DKJ 45°</p>
<p><b>39</b> Dg-7</p>  <p>Female JIC 37° – Swivel 90° Elbow ISO 12151-5-SWES – DKJ 90°</p>			

## Flange

Page Dg-8 – Dg-12			
<p><b>15/4A</b> Dg-8</p>  <p>SAE Code 61 Flange Straight ISO 12151-3-S-L – SFL 5000 psi</p>	<p><b>17/4F</b> Dg-8</p>  <p>SAE Code 61 Flange 45° Elbow ISO 12151-3 – E45S – L – SFL 45° 5000 psi</p>	<p><b>19/4N</b> Dg-9</p>  <p>SAE Code 61 Flange 90° Elbow ISO 12151-3-E-L – SFL 90° 5000 psi</p>	<p><b>6A</b> Dg-9</p>  <p>SAE Code 62 Flange Straight ISO 12151-3-S-S – SFS 6000 psi</p>
<p><b>6F</b> Dg-10</p>  <p>SAE Code 62 Flange 45° Elbow – Heavy Series ISO 12151-3 – E45-S – SFS 45° 6000 psi</p>	<p><b>6N</b> Dg-10</p>  <p>SAE Code 62 Flange 90° Elbow ISO 12151-3 – E-S – SFS 90° 6000 psi</p>	<p><b>XA</b> Dg-11</p>  <p>Caterpillar® Flange Straight</p>	<p><b>XF</b> Dg-11</p>  <p>Caterpillar® Flange 45° Elbow</p>
<p><b>XG</b> Dg-12</p>  <p>Caterpillar® Flange 60° Elbow</p>	<p><b>XN</b> Dg-12</p>  <p>Caterpillar® Flange 90° Elbow</p>		

## ORFS

Page Dg-13 – Dg-15			
<p><b>JC</b> Dg-13</p>  <p>Female ORFS Swivel – Straight Short ISO 12151-1 – SWSA SAE J516 – ORFS</p>	<p><b>JS</b> Dg-13</p>  <p>ORFS Swivel Female (Long) ISO 12151-1-SWSB SAE J516 – ORFS</p>	<p><b>J7</b> Dg-14</p>  <p>Female ORFS – Swivel 45° Elbow ISO 12151-1 – SWE 45° SAE J516 – ORFS 45°</p>	<p><b>J9</b> Dg-14</p>  <p>Female ORFS – Swivel 90° Elbow – Short Drop ISO 12151-1 – SWES SAE J516 – ORFS 90°</p>
<p><b>JM</b> Dg-15</p>  <p>ORFS Male ISO 12151-1-S – SAE J516</p>			



## C9 Female Metric 24° – Swivel Heavy Series with O-Ring Straight

ISO 12151-2-SWS-S – DKOS

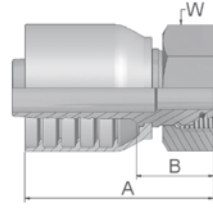

XXXXX-XX-XX Part Number 78	Hose I.D.				Thread metric	Tube O.D. mm	A mm	B mm	W mm
	DN	Inch	Size	mm					
1C978-20-12	20	3/4	-12	19.1	M30x2	20	86	35	36
1C978-25-12	20	3/4	-12	19.1	M36x2	25	79	31	46
1C978-30-16	25	1	-16	25.4	M42x2	30	87	36	50
1C978-30-20	32	1-1/4	-20	31.8	M42x2	30	106	42	50
1C978-38-20	32	1-1/4	-20	31.8	M52x2	38	101	37	60
1C978-38-24	40	1-1/2	-24	38.1	M52x2	38	105	42	60

Fittings with standard O-ring seals can be used for temperatures from -30 °C up to +105 °C.  
Find O-rings in section E. Special O-rings are available on request.

## OC Female Metric 24° – Swivel Heavy Series with O-Ring 45° Elbow

ISO 12151-2 – SWE 45°-S – DKOS 45°

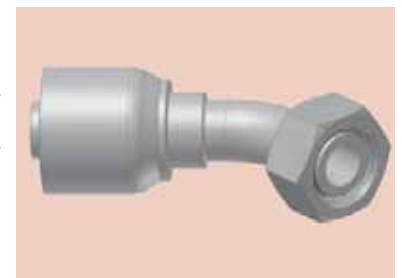
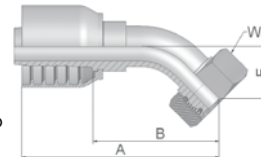

XXXXX-XX-XX Part Number 78	Hose I.D.				Thread metric	Tube O.D. mm	A mm	B mm	E mm	W mm
	DN	Inch	Size	mm						
10C78-25-12	20	3/4	-12	19.1	M36x2	25	112	64	29	46
10C78-30-16	25	1	-16	25.4	M42x2	30	131	81	34	50
10C78-38-20	32	1-1/4	-20	31.8	M52x2	38	161	97	37	60
10C78-38-24	40	1-1/2	-24	38.1	M52x2	38	182	120	49	60

Fittings with standard O-ring seals can be used for temperatures from -30 °C up to +105 °C.  
Find O-rings in section E. Special O-rings are available on request.

Approved **fitting series** for hose types:

78 781 782TC

# 1C Female Metric 24° – Swivel Heavy Series with O-Ring 90° Elbow

ISO 12151-2-SWE-S – DKOS 90°

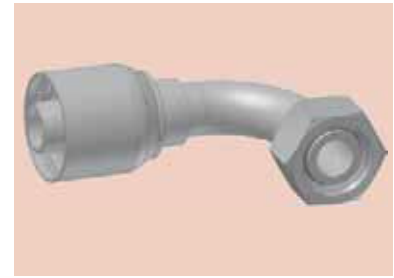
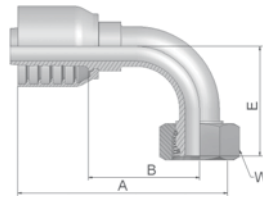

XXXXX-XX-XX Part Number 78	Hose I.D.				Thread metric	Tube O.D. mm	A mm	B mm	E mm	W mm
	DN	Inch	Size	mm						
11C78-20-12	20	3/4	-12	19.1	M30x2	20	101	53	57	36
11C78-25-12	20	3/4	-12	19.1	M36x2	25	101	53	59	46
11C78-30-16	25	1	-16	25.4	M42x2	30	122	71	73	50
11C78-38-20	32	1-1/4	-20	31.8	M52x2	38	151	87	78	60

Fittings with standard O-ring seals can be used for temperatures from -30 °C up to +105 °C.  
Find O-rings in section E. Special O-rings are available on request.

# D2 Male Metric 24° – Rigid Heavy Series – Straight

ISO 12151-2-S-S – CES

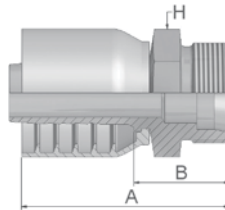

XXXXX-XX-XX Part Number 78	Hose I.D.				Thread metric	Tube O.D. mm	A mm	B mm	H mm
	DN	Inch	Size	mm					
1D278-25-12	20	3/4	-12	19.1	M36x2	25	86	38	36
1D278-30-16	25	1	-16	25.4	M42x2	30	95	42	46
1D278-38-20	32	1-1/4	-20	31.8	M52x2	38	112	46	55

Approved **fitting series** for hose types:

78 781 782TC



## 92 Female BSP Parallel Pipe Swivel – Straight (60° Cone)

BS5200-A – DKR

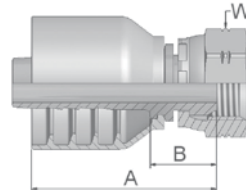

XXXXX-XX-XX Part Number 78	Hose I.D.				Thread BSP	A mm	B mm	W mm
	DN	Inch	Size	mm				
19278-12-12	20	3/4	-12	19.1	3/4x14	77	29	32
19278-16-16	25	1	-16	25.4	1x11	89	39	41
19278-20-20	32	1-1/4	-20	31.8	1-1/4x11	101	37	50
19278-24-24	40	1-1/2	-24	38.1	1-1/2x11	100	37	55

## B1 Female BSP Parallel Pipe Swivel 45° Elbow (60° Cone)

BS 5200-D – DKR 45°

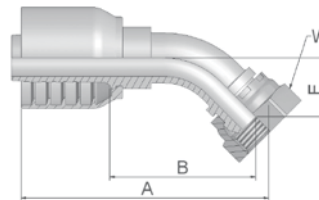

XXXXX-XX-XX Part Number 78	Hose I.D.				Thread BSP	A mm	B mm	E mm	W mm
	DN	Inch	Size	mm					
1B178-12-12	20	3/4	-12	19.1	3/4x14	110	62	26	32
1B178-16-16	25	1	-16	25.4	1x11	134	81	38	41
1B178-20-20	32	1-1/4	-20	31.8	1-1/4x11	168	104	43	50
1B178-24-24	40	1-1/2	-24	38.1	1-1/2x11	186	123	52	55

Approved **fitting series** for hose types:

78 781 782TC

## B2 Female BSP Parallel Pipe Swivel 90° Elbow (60° Cone)

BS 5200-B – DKR 90°

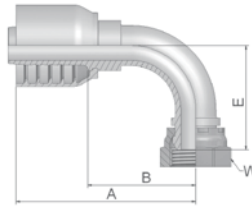

XXXXX-XX-XX Part Number 78	Hose I.D.				Thread BSP	A mm	B mm	E mm	W mm
	DN	Inch	Size	mm					
1B278-12-12	20	3/4	-12	19.1	3/4x14	106	58	55	32
1B278-16-16	25	1	-16	25.4	1x11	121	70	76	41
1B278-20-20	32	1-1/4	-20	31.8	1-1/4x11	151	87	80	50
1B278-24-24	40	1-1/2	-24	38.1	1-1/2x11	166	103	103	55

## D9 Male BSP Parallel Pipe Rigid – Straight (60° Cone)

BS5200 – AGR

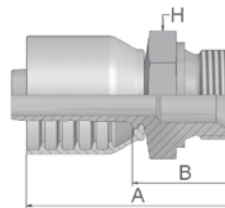

XXXXX-XX-XX Part Number 78	Hose I.D.				Thread BSP	A mm	B mm	H mm
	DN	Inch	Size	mm				
1D978-12-12	20	3/4	-12	19.1	3/4x14	87	39	32
1D978-16-16	25	1	-16	25.4	1x11	96	45	41
1D978-20-20	32	1-1/4	-20	31.8	1-1/4x11	113	49	50
1D978-24-24	40	1-1/2	-24	38.1	1-1/2x11	114	51	55

Approved **fitting series** for hose types:

78 781 782TC

# 01

## Male NPTF Pipe Rigid – Straight

SAE J476A / J516 – AGN

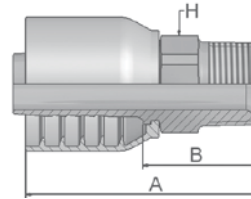

XXXXX-XX-XX Part Number 78	Hose I.D.				Thread NPTF	A mm	B mm	H mm
	DN	Inch	Size	mm				
10178-12-12-SM	20	3/4	-12	19.1	3/4x14	90	42	30
10178-16-16-SM	25	1	-16	25.4	1x11-1/2	100	50	36
10178-20-20-SM	32	1-1/4	-20	31.8	1-1/4x11-1/2	125	61	46
10178-24-24-SM	40	1-1/2	-24	38.1	1-1/2x11-1/2	124	61	50

# 03

## Male JIC 37° – Rigid Straight

ISO12151-5-S – AGJ

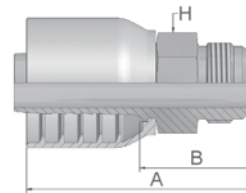

XXXXX-XX-XX Part Number 78	Hose I.D.				Thread UNF	A mm	B mm	H mm
	DN	Inch	Size	mm				
10378-12-12-SM	20	3/4	-12	19.1	1-1/16x12	89	41	30
10378-16-16-SM	25	1	-16	25.4	1-5/16x12	97	47	36
10378-20-20-SM	32	1-1/4	-20	31.8	1-5/8x12	118	54	46
10378-24-24-SM	40	1-1/2	-24	38.1	1-7/8x12	122	59	50

Approved **fitting series** for hose types:

SM: Metric Hexagon

78 781 782TC

## 06 Female JIC 37° – Swivel Straight

ISO12151-5-SWS – DKJ

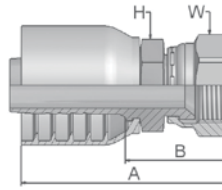

XXXXX-XX-XX Part Number 78	Hose I.D.				Thread UNF	A mm	B mm	H mm	W mm
	DN	Inch	Size	mm					
10678-12-12-SM	20	3/4	-12	19.1	1-1/16x12	93	45	30	32
10678-16-16-SM	25	1	-16	25.4	1-5/16x12	103	52	36	41
10678-16-20-SM	32	1-1/4	-20	31.8	1-5/16x12	116	52	46	41
10678-20-20-SM	32	1-1/4	-20	31.8	1-5/8x12	125	61	46	50
10678-24-24-SM	40	1-1/2	-24	38.1	1-7/8x12	128	66	50	60

## 37 Female JIC 37° – Swivel 45° Elbow

ISO 12151-5-SWE 45° – DKJ 45°

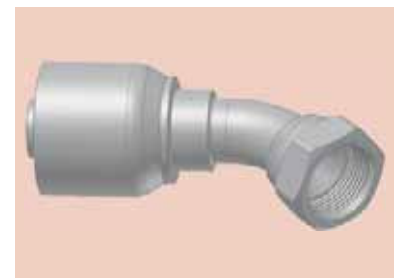
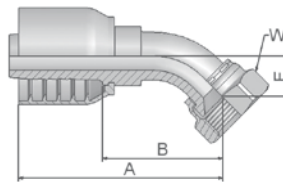

XXXXX-XX-XX Part Number 78	Hose I.D.				Thread UNF	A mm	B mm	E mm	W mm
	DN	Inch	Size	mm					
13778-12-12-SM	20	3/4	-12	19.1	1-1/16x12	104	56	22	32
13778-16-16-SM	25	1	-16	25.4	1-5/16x12	119	69	24	41
13778-20-20-SM	32	1-1/4	-20	31.8	1-5/8x12	172	108	47	50
13778-24-24-SM	40	1-1/2	-24	38.1	1-7/8x12	194	132	58	60

Approved **fitting series** for hose types:

SM: Metric Hexagon

78 781 782TC

# 39 Female JIC 37° – Swivel 90° Elbow

ISO 12151-5-SWES – DKJ 90°

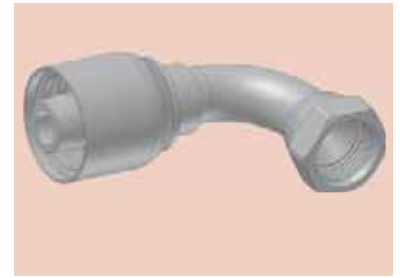
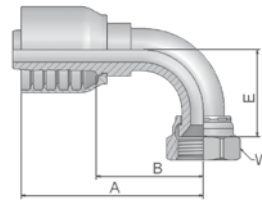

XXXXX-XX-XX Part Number 78	Hose I.D.				Thread UNF	A mm	B mm	E mm	W mm
	DN	Inch	Size	mm					
13978-12-12-SM	20	3/4	-12	19.1	1-1/16x12	101	53	48	32
13978-16-16-SM	25	1	-16	25.4	1-5/16x12	118	67	56	41
13978-20-20-SM	32	1-1/4	-20	31.8	1-5/8x12	151	87	85	50
13978-24-24-SM	40	1-1/2	-24	38.1	1-7/8x12	194	119	102	60

Approved **fitting series** for hose types:

SM: Metric Hexagon

78 781 782TC

## 15/4A SAE Code 61 Flange Straight

ISO 12151-3-S-L – SFL  
5000 psi

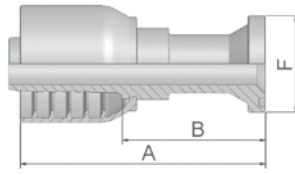

XXXXX-XX-XX Part Number 78	Hose I.D.				Flange	A mm	B mm	F mm
	DN	Inch	Size	mm				
11578-12-12	20	3/4	-12	19.1	3/4	110	62	38
11578-16-16	25	1	-16	25.4	1	117	66	45
14A78-20-16	25	1	-16	25.4	1-1/4	85	34	51
11578-16-20	32	1-1/4	-20	31.8	1	133	69	45
14A78-20-20	32	1-1/4	-20	31.8	1-1/4	141	77	51
14A78-24-20	32	1-1/4	-20	31.8	1-1/2	104	39	60
14A78-24-24	40	1-1/2	-24	38.1	1-1/2	166	103	60

Find SAE flange halves in section Eb.

Fittings with standard O-ring seals can be used for temperatures from -30 °C up to +105 °C.

Find O-rings in section E. Special O-rings are available on request.

## 17/4F SAE Code 61 Flange 45° Elbow

ISO 12151-3 – E45S – L – SFL 45°  
5000 psi

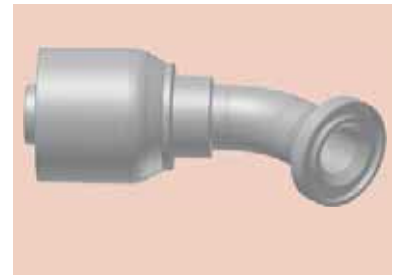
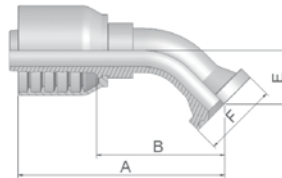

XXXXX-XX-XX Part Number 78	Hose I.D.				Flange	A mm	B mm	E mm	F mm
	DN	Inch	Size	mm					
11778-12-12	20	3/4	-12	19.1	3/4	119	71	27	38
11778-16-16	25	1	-16	25.4	1	127	77	32	45
14F78-20-16	25	1	-16	25.4	1-1/4	136	85	32	51
14F78-20-20	32	1-1/4	-20	31.8	1-1/4	160	96	35	51
14F78-24-20	32	1-1/4	-20	31.8	1-1/2	162	102	38	60
14F78-24-24	40	1-1/2	-24	38.1	1-1/2	178	115	44	60
14F78-32-24	40	1-1/2	-24	38.1	2	177	114	43	71

Find SAE flange halves in section Eb.

Fittings with standard O-ring seals can be used for temperatures from -30 °C up to +105 °C.

Find O-rings in section E. Special O-rings are available on request.

Approved **fitting series** for hose types:

78 781 782TC

# 19/4N SAE Code 61 Flange 90° Elbow

ISO 12151-3-E-L – SFL 90°  
5000 psi

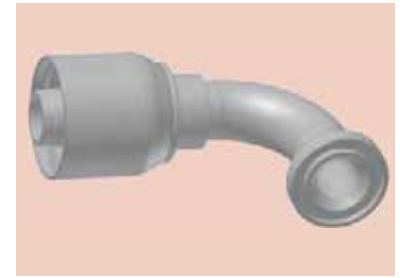
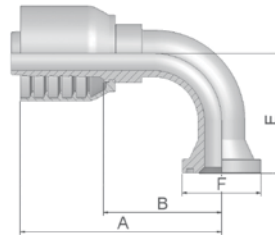

XXXXX-XX-XX Part Number 78	Hose I.D.				Flange	A mm	B mm	E mm	F mm
	DN	Inch	Size	mm					
11978-12-12	20	3/4	-12	19.1	3/4	109	61	58	38
11978-16-12	20	3/4	-12	19.1	1	102	54	58	45
11978-16-16	25	1	-16	25.4	1	118	67	70	45
14N78-20-16	25	1	-16	25.4	1-1/4	128	78	70	51
14N78-20-20	32	1-1/4	-20	31.8	1-1/4	155	91	90	51
14N78-24-20	32	1-1/4	-20	31.8	1-1/2	155	91	90	60
14N78-24-24	40	1-1/2	-24	38.1	1-1/2	166	103	104	60

Find SAE flange halves in section Eb.

Fittings with standard O-ring seals can be used for temperatures from -30 °C up to +105 °C.

Find O-rings in section E. Special O-rings are available on request.

# 6A SAE Code 62 Flange Straight

ISO 12151-3-S-S – SFS  
6000 psi

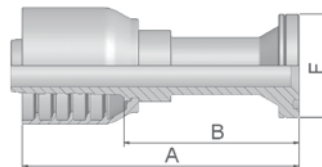

XXXXX-XX-XX Part Number 78	Hose I.D.				Flange	A mm	B mm	F mm
	DN	Inch	Size	mm				
16A78-12-12	20	3/4	-12	19.1	3/4	130	82	41
16A78-16-12	20	3/4	-12	19.1	1	135	87	48
16A78-16-16	25	1	-16	25.4	1	131	81	48
16A78-20-16	25	1	-16	25.4	1-1/4	100	50	54
16A78-16-20	32	1-1/4	-20	31.8	1	149	85	48
16A78-20-20	32	1-1/4	-20	31.8	1-1/4	149	85	54
16A78-24-20	32	1-1/4	-20	31.8	1-1/2	121	57	64
16A78-20-24	40	1-1/2	-24	38.1	1-1/4	158	96	54
16A78-24-24	40	1-1/2	-24	38.1	1-1/2	166	104	64
16A78-32-24	40	1-1/2	-24	38.1	2	129	66	79

Find SAE flange halves in section Eb.

Fittings with standard O-ring seals can be used for temperatures from -30 °C up to +105 °C.

Find O-rings in section E. Special O-rings are available on request.

Approved **fitting series** for hose types:

78 781 782TC

## 6F SAE Code 62 Flange 45° Elbow – Heavy Series

ISO 12151-3 – E45-S – SFS 45°  
6000 psi

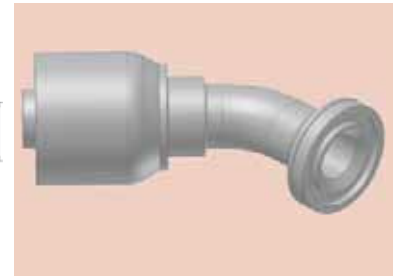
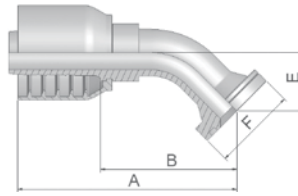

XXXXX-XX-XX Part Number 78	Hose I.D.				Flange	A mm	B mm	E mm	F mm
	DN	Inch	Size	mm					
16F78-12-12	20	3/4	-12	19.1	3/4	109	61	26	41
16F78-16-12	20	3/4	-12	19.1	1	110	62	26	48
16F78-16-16	25	1	-16	25.4	1	129	79	32	48
16F78-20-16	25	1	-16	25.4	1-1/4	129	79	32	54
16F78-16-20	32	1-1/4	-20	31.8	1	157	93	33	48
16F78-20-20	32	1-1/4	-20	31.8	1-1/4	163	98	38	54
16F78-24-20	32	1-1/4	-20	31.8	1-1/2	163	99	38	63
16F78-24-20	32	1-1/4	-20	31.8	1-1/2	162	98	38	54
16F78-24-24	40	1-1/2	-24	38.1	1-1/2	178	115	44	64

Find SAE flange halves in section Eb.

Fittings with standard O-ring seals can be used for temperatures from -30 °C up to +105 °C.

Find O-rings in section E. Special O-rings are available on request.

## 6N SAE Code 62 Flange 90° Elbow

ISO 12151-3 – E-S – SFS 90°  
6000 psi

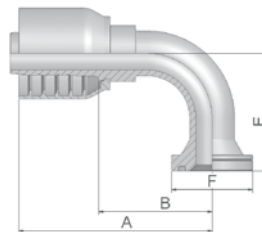

XXXXX-XX-XX Part Number 78	Hose I.D.				Flange	A mm	B mm	E mm	F mm
	DN	Inch	Size	mm					
16N78-12-12	20	3/4	-12	19.1	3/4	101	53	58	41
16N78-16-12	20	3/4	-12	19.1	1	111	63	58	48
16N78-12-16	25	1	-16	25.4	3/4	108	57	70	41
16N78-16-16	25	1	-16	25.4	1	122	71	70	48
16N78-20-16	25	1	-16	25.4	1-1/4	122	71	70	54
16N78-16-20	32	1-1/4	-20	31.8	1	137	73	90	48
16N78-20-20	32	1-1/4	-20	31.8	1-1/4	172	108	90	54
16N78-24-20	32	1-1/4	-20	31.8	1-1/2	172	108	76	64
16N78-20-24	40	1-1/2	-24	38.1	1-1/4	170	113	76	54
16N78-24-24	40	1-1/2	-24	38.1	1-1/2	166	103	104	64
16N78-32-24	40	1-1/2	-24	38.1	2	166	103	104	79

Find SAE flange halves in section Eb.

Fittings with standard O-ring seals can be used for temperatures from -30 °C up to +105 °C.

Find O-rings in section E. Special O-rings are available on request.

Approved **fitting series** for hose types:

78 781 782TC



## XA Caterpillar® Flange Straight

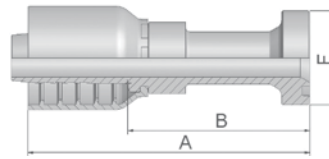

XXXXX-XX-XX Part Number 78	Hose I.D.				Flange	A mm	B mm	F mm
	DN	Inch	Size	mm				
1XA78-12-12	20	3/4	-12	19.1	3/4	123	75	41
1XA78-16-12	20	3/4	-12	19.1	1	86	38	48
1XA78-16-16	25	1	-16	25.4	1	138	88	48
1XA78-20-16	25	1	-16	25.4	1-1/4	91	40	54
1XA78-20-20	32	1-1/4	-20	31.8	1-1/4	155	96	54
1XA78-24-20	32	1-1/4	-20	31.8	1-1/2	162	97	64
1XA78-24-24	40	1-1/2	-24	38.1	1-1/2	172	110	64

Fittings with standard O-ring seals can be used for temperatures from -30 °C up to +105 °C.  
Find O-rings in section E. Special O-rings are available on request.

## XF Caterpillar® Flange 45° Elbow

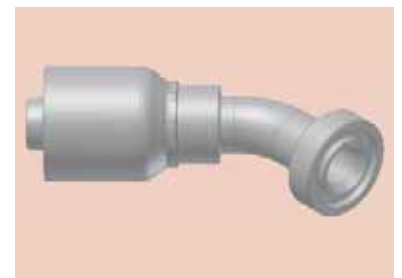
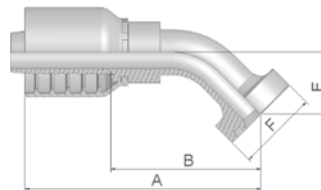

XXXXX-XX-XX Part Number 78	Hose I.D.				Flange	A mm	B mm	E mm	F mm
	DN	Inch	Size	mm					
1XF78-12-12	20	3/4	-12	19.1	3/4	123	75	31	41
1XF78-16-12	20	3/4	-12	19.1	1	122	74	31	48
1XF78-16-16	25	1	-16	25.4	1	139	88	36	48
1XF78-20-16	25	1	-16	25.4	1-1/4	132	81	35	54
1XF78-20-20	32	1-1/4	-20	31.8	1-1/4	162	98	37	54
1XF78-24-20	32	1-1/4	-20	31.8	1-1/2	182	117	36	64
1XF78-24-24	40	1-1/2	-24	38.1	1-1/2	173	110	39	64

Fittings with standard O-ring seals can be used for temperatures from -30 °C up to +105 °C.  
Find O-rings in section E. Special O-rings are available on request.

Approved **fitting series** for hose types:

78 781 782TC

**XG** Caterpillar® Flange  
60° Elbow

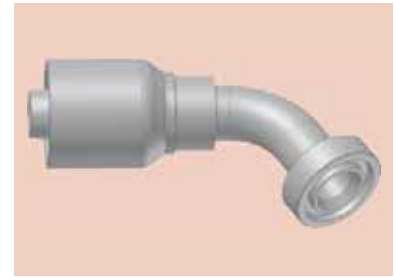
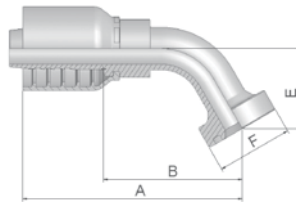

XXXXX-XX-XX Part Number 78	Hose I.D.				Flange	A mm	B mm	E mm	F mm
	DN	Inch	Size	mm					
1XG78-12-12	20	3/4	-12	19.1	3/4	138	90	42	41
1XG78-16-16	25	1	-16	25.4	1	160	109	50	48
1XG78-20-16	25	1	-16	25.4	1-1/4	153	103	48	54
1XG78-20-20	32	1-1/4	-20	31.8	1-1/4	201	137	55	54
1XG78-24-24	40	1-1/2	-24	38.1	1-1/2	212	149	52	64

Fittings with standard O-ring seals can be used for temperatures from -30 °C up to +105 °C.  
Find O-rings in section E. Special O-rings are available on request.

**XN** Caterpillar® Flange  
90° Elbow

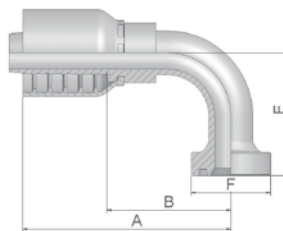

XXXXX-XX-XX Part Number 78	Hose I.D.				Flange	A mm	B mm	E mm	F mm
	DN	Inch	Size	mm					
1XN78-12-12	20	3/4	-12	19.1	3/4	111	63	63	41
1XN78-16-12	20	3/4	-12	19.1	1	111	63	62	48
1XN78-16-16	25	1	-16	25.4	1	128	78	74	48
1XN78-20-16	25	1	-16	25.4	1-1/4	122	71	74	54
1XN78-20-20	32	1-1/4	-20	31.8	1-1/4	172	108	77	54
1XN78-24-20	32	1-1/4	-20	31.8	1-1/2	172	107	77	64
1XN78-24-24	40	1-1/2	-24	38.1	1-1/2	166	103	106	64

Fittings with standard O-ring seals can be used for temperatures from -30 °C up to +105 °C.  
Find O-rings in section E. Special O-rings are available on request.

Approved **fitting series** for hose types:

78 781 782TC

# JC

## Female ORFS Swivel – Straight Short

ISO 12151-1 – SWSA  
SAE J516 – ORFS

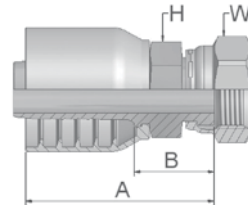

XXXXX-XX-XX Part Number 78	Hose I.D.				Thread UNF	A mm	B mm	H mm	W mm
	DN	Inch	Size	mm					
1JC78-12-12-SM	20	3/4	-12	19.1	1-3/16x12	81	33	30	36
1JC78-20-20-SM	32	1-1/4	-20	31.8	1-11/16x12	106	42	46	50

# JS

## ORFS Swivel Female (Long)

ISO 12151-1-SWSB  
SAE J516 – ORFS

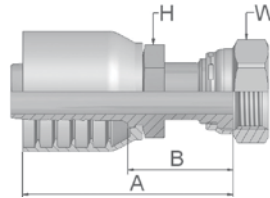

XXXXX-XX-XX Part Number 78	Hose I.D.				Thread UNF	A mm	B mm	H mm	W mm
	DN	Inch	Size	mm					
1JS78-12-12-SM	20	3/4	-12	19.1	1-3/16x12	98	50	30	36
1JS78-16-16-SM	25	1	-16	25.4	1-7/16x12	103	52	36	41
1JS78-20-16-SM	25	1	-16	25.4	1-11/16x12	114	64	41	50
1JS78-20-20-SM	32	1-1/4	-20	31.8	1-11/16x12	118	54	46	50
1JS78-24-24-SM	40	1-1/2	-24	38.1	2x12	120	57	50	60

Approved fitting series for hose types:

SM: Metric Hexagon

78 781 782TC

## J7 Female ORFS – Swivel 45° Elbow

ISO 12151-1 – SWE 45°  
SAE J516 – ORFS 45°

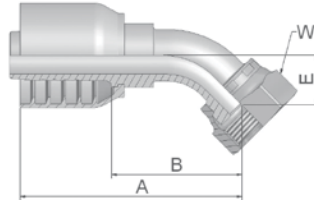

XXXXX-XX-XX Part Number 78	Hose I.D.				Thread UNF	A mm	B mm	E mm	W mm
	DN	Inch	Size	mm					
1J778-12-12-SM	20	3/4	-12	19.1	1-3/16x12	105	57	21	36
1J778-16-16-SM	25	1	-16	25.4	1-7/16x12	119	69	24	41
1J778-20-16-SM	25	1	-16	25.4	1-11/16x12	131	80	26	50

## J9 Female ORFS – Swivel 90° Elbow – Short Drop

ISO 12151-1 – SWES  
SAE J516 – ORFS 90°

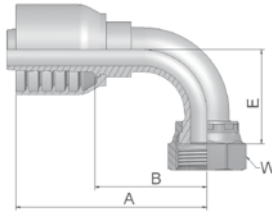

XXXXX-XX-XX Part Number 78	Hose I.D.				Thread UNF	A mm	B mm	E mm	W mm
	DN	Inch	Size	mm					
1J978-12-12-SM	20	3/4	-12	19.1	1-3/16x12	101	53	48	36
1J978-16-12-SM	20	3/4	-12	19.1	1-7/16x12	114	66	56	41
1J978-16-16-SM	25	1	-16	25.4	1-7/16x12	120	70	56	41
1J978-20-16-SM	25	1	-16	25.4	1-11/16x12	127	77	64	50
1J978-20-20-SM	32	1-1/4	-20	31.8	1-11/16-12	151	87	69	50

Approved **fitting series** for hose types:

SM: Metric Hexagon

78 781 782TC

**JM**

**ORFS Male**

ISO 12151-1-S – SAE J516

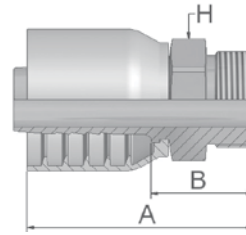

XXXXX-XX-XX Part Number 78	Hose I.D.				Thread UNF	A mm	B mm	H mm
	DN	Inch	Size	mm				
1JM78-16-16-SM	25	1	-16	25.4	1-7/16x12	93	42	41
1JM78-20-16-SM	25	1	-16	25.4	1-11/16x12	89	39	46
1JM78-24-20-SM	32	1-1/4	-20	31.8	2x12	108	44	55



JM fittings are supplied without O-ring.  
Find O-rings in section E. Special O-rings are available on request.

Approved **fitting series** for hose types:

SM: Metric Hexagon

78 781 782TC



## DIN – Metric

Page Dh-1 – Dh-2		
<b>C9</b> Dh-1 	<b>0C</b> Dh-1 	<b>1C</b> Dh-2 
Female Metric 24° – Swivel Heavy Series with O-Ring Straight ISO 12151-2-SWS-S – DKOS	Female Metric 24° – Swivel Heavy Series with O-Ring 45° Elbow ISO 12151-2 – SWE 45°-S – DKOS 45°	Female Metric 24° – Swivel Heavy Series with O-Ring 90° Elbow ISO 12151-2-SWE-S – DKOS 90°

## Flange

Page Dh-3 – Dh-4		
<b>6A</b> Dh-3 	<b>6F</b> Dh-3 	<b>6N</b> Dh-4 
SAE Code 62 Flange Straight ISO 12151-3-S-S – SFS 6000 psi	SAE Code 62 Flange 45° Elbow – Heavy Series ISO 12151-3 – E45-S – SFS 45° 6000 psi	SAE Code 62 Flange 90° Elbow ISO 12151-3 – E-S – SFS 90° 6000 psi

## ORFS

Page Dh-5 – Dh-6		
<b>JS</b> Dh-5 	<b>J7</b> Dh-5 	<b>J9</b> Dh-6 
ORFS Swivel Female (Long) ISO 12151-1-SWSB SAE J516 – ORFS	Female ORFS – Swivel 45° Elbow ISO 12151-1 – SWE 45° SAE J516 – ORFS 45°	Female ORFS – Swivel 90° Elbow – Short Drop ISO 12151-1 – SWES SAE J516 – ORFS 90°

## C9 Female Metric 24° – Swivel Heavy Series with O-Ring Straight

ISO 12151-2-SWS-S – DKOS

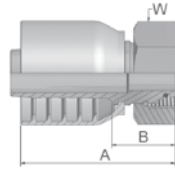

XXXXX-XX-XX Part Number 79	Hose I.D.				Thread metric	A mm	B mm	W mm
	DN	Inch	Size	mm				
1C979-25-12	20	3/4	-12	19.1	M36x2	87	32	46
1C979-30-16	25	1	-16	25.4	M42x2	95	36	50

Fittings with standard O-ring seals can be used for temperatures from -30 °C up to +105 °C.  
Find O-rings in section E. Special O-rings are available on request.

## 0C Female Metric 24° – Swivel Heavy Series with O-Ring 45° Elbow

ISO 12151-2 – SWE 45°-S – DKOS 45°

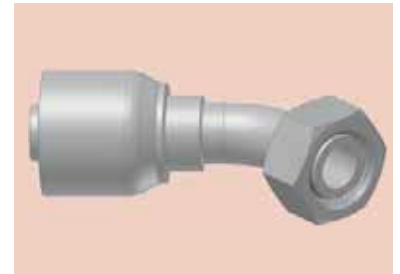
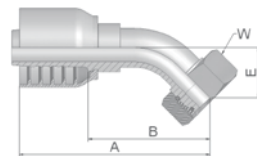

XXXXX-XX-XX Part Number 79	Hose I.D.				Thread metric	A mm	B mm	E mm	W mm
	DN	Inch	Size	mm					
10C79-25-12	20	3/4	-12	19.1	M36x2	125	69	29	46
10C79-30-16	25	1	-16	25.4	M42x2	140	81	34	50

Fittings with standard O-ring seals can be used for temperatures from -30 °C up to +105 °C.  
Find O-rings in section E. Special O-rings are available on request.

Approved **fitting series** for hose types:

79 791TC 792TC F42

# 1C Female Metric 24° – Swivel Heavy Series with O-Ring 90° Elbow

ISO 12151-2-SWE-S – DKOS 90°

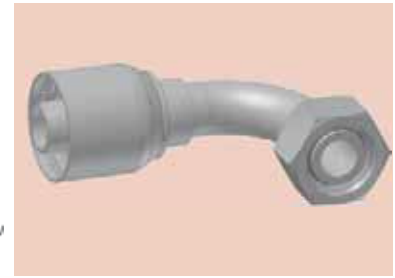
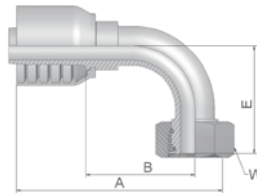

XXXXX-XX-XX Part Number 79	Hose I.D.				Thread metric	A mm	B mm	E mm	W mm
	DN	Inch	Size	mm					
11C79-25-12	20	3/4	-12	19.1	M36x2	114	58	59	46
11C79-30-16	25	1	-16	25.4	M42x2	130	72	73	50

Fittings with standard O-ring seals can be used for temperatures from -30 °C up to +105 °C.  
Find O-rings in section E. Special O-rings are available on request.

Approved **fitting series** for hose types:

79 791TC 792TC F42



## 6A SAE Code 62 Flange Straight

ISO 12151-3-S-S – SFS  
6000 psi

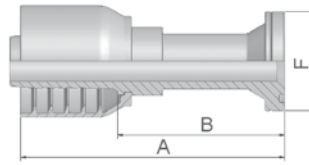

XXXXX-XX-XX Part Number 79	Hose I.D.				Flange	A mm	B mm	F mm
	DN	Inch	Size	mm				
16A79-12-12	20	3/4	-12	19.1	3/4	124	72	41
16A79-16-12	20	3/4	-12	19.1	1	99	43	48
16A79-12-16	25	1	-16	25.4	3/4	132	73	41
16A79-16-16	25	1	-16	25.4	1	139	81	48
16A79-20-16	25	1	-16	25.4	1-1/4	109	50	54
16A79-16-20	32	1-1/4	-20	31.8	1	152	81	48
16A79-20-20	32	1-1/4	-20	31.8	1-1/4	158	87	54
16A79-24-20	32	1-1/4	-20	31.8	1-1/2	132	61	64

Find SAE flange halves in section Eb.  
Fittings with standard O-ring seals can be used for temperatures from -30 °C up to +105 °C.  
Special O-rings are available on request.

## 6F SAE Code 62 Flange 45° Elbow – Heavy Series

ISO 12151-3 – E45-S – SFS 45°  
6000 psi

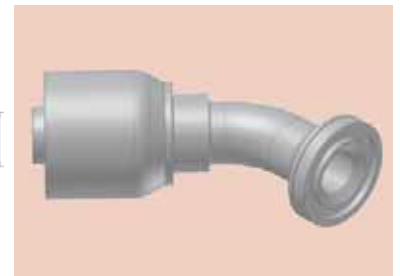
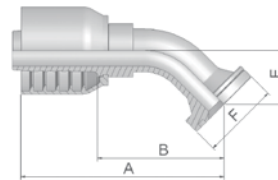

XXXXX-XX-XX Part Number 79	Hose I.D.				Flange	A mm	B mm	E mm	F mm
	DN	Inch	Size	mm					
16F79-12-12	20	3/4	-12	19.1	3/4	117	65	26	41
16F79-12-16	25	1	-16	25.4	3/4	128	70	32	41
16F79-16-16	25	1	-16	25.4	1	137	79	32	48
16F79-20-16	25	1	-16	25.4	1-1/4	137	79	32	54
16F79-16-20	32	1-1/4	-20	31.8	1	161	89	38	48
16F79-20-20	32	1-1/4	-20	31.8	1-1/4	172	104	38	54
16F79-24-20	32	1-1/4	-20	31.8	1-1/2	172	101	38	64

Find SAE flange halves in section Eb.  
Fittings with standard O-ring seals can be used for temperatures from -30 °C up to +105 °C.  
Special O-rings are available on request.

Approved **fitting series** for hose types:

79 791TC 792TC F42

# 6N

## SAE Code 62 Flange 90° Elbow

ISO 12151-3 – E-S – SFS 90°  
6000 psi

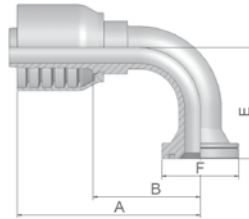

XXXXX-XX-XX Part Number 79	Hose I.D.				Flange	A mm	B mm	E mm	F mm
	DN	Inch	Size	mm					
16N79-12-12	20	3/4	-12	19.1	3/4	109	53	58	41
16N79-16-12	20	3/4	-12	19.1	1	109	53	58	48
16N79-12-16	25	1	-16	25.4	3/4	116	57	70	41
16N79-16-16	25	1	-16	25.4	1	130	72	70	48
16N79-20-16	25	1	-16	25.4	1-1/4	126	71	70	54
16N79-16-20	32	1-1/4	-20	31.8	1	148	76	90	48
16N79-20-20	32	1-1/4	-20	31.8	1-1/4	161	89	90	54
16N79-24-20	32	1-1/4	-20	31.8	1-1/2	160	89	90	64
16N79-24-24	40	1-1/2	-24	38.1	1-1/2	190	113	104	64

Find SAE flange halves in section Eb.

Fittings with standard O-ring seals can be used for temperatures from -30 °C up to +105 °C.

Special O-rings are available on request.

Approved **fitting series** for hose types:

79 791TC 792TC F42

## JS ORFS Swivel Female (Long)

ISO 12151-1-SWSB  
SAE J516 – ORFS

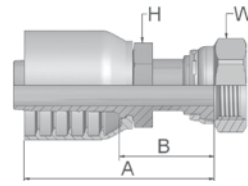

XXXXX-XX-XX Part Number 79	Hose I.D.				Thread UNF	A mm	B mm	H mm Inch	W mm Inch
	DN	Inch	Size	mm					
1JS79-12-12	20	3/4	-12	19.1	1-3/16x12	101	49	1-1/8	1-3/8
1JS79-16-16-SM	25	1	-16	25.4	1-7/16x12	113	55	36	41
1JS79-20-16-SM	25	1	-16	25.4	1-11/16x12	109	51	41	50
1JS79-20-20	32	1-1/4	-20	31.8	1-11/16x12	127	59	1-3/4	1-7/8

## J7 Female ORFS – Swivel 45° Elbow

ISO 12151-1 – SWE 45°  
SAE J516 – ORFS 45°

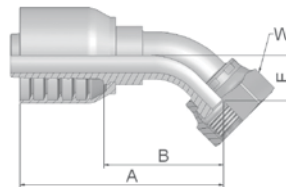

XXXXX-XX-XX Part Number 79	Hose I.D.				Thread UNF	A mm	B mm	E mm	W mm Inch
	DN	Inch	Size	mm					
1J779-12-12-SM	20	3/4	-12	19.1	1-3/16x12	113	57	21	36
1J779-16-16-SM	25	1	-16	25.4	1-7/16x12	135	76	24	41
1J779-20-20	32	1-1/4	-20	31.8	1-11/16x12	156	89	25	1-7/8

Approved fitting series for hose types:

SM: Metric Hexagon

79 791TC 792TC F42

# J9 Female ORFS – Swivel 90° Elbow – Short Drop

ISO 12151-1 – SWES  
SAE J516 – ORFS 90°

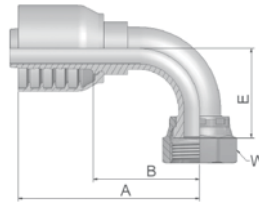

XXXXX-XX-XX Part Number 79	Hose I.D.				Thread UNF	A mm	B mm	E mm	W mm Inch
	DN	Inch	Size	mm					
1J979-12-12-SM	20	3/4	-12	19.1	1-3/16x12	109	53	48	36
1J979-16-16	25	1	-16	25.4	1-7/16x12	126	71	56	1-5/8
1J979-20-20-SM	32	1-1/4	-20	31.8	1-11/16x12	160	89	69	50



Approved **fitting series** for hose types:

SM: Metric Hexagon







79 791TC 792TC F42



## SAE

Page Di-1	
<p><b>01</b> Di-1</p>  <p>Male NPTF Pipe Rigid – Straight SAE J476A / J516 – AGN</p>	<p><b>06</b> Di-1</p>  <p>Female JIC 37° – Swivel Straight ISO12151-5-SWS – DKJ</p>

## Flange

Page Di-2 – Di-3			
<p><b>4A</b> Di-2</p>  <p>SAE Code 61 Flange Straight ISO 12151-3-S-L – SFL 5000 psi</p>	<p><b>4F</b> Di-2</p>  <p>SAE Code 61 Flange 45° Elbow ISO 12151-3 – E45S – L – SFL 45° 5000 psi</p>	<p><b>4N</b> Di-2</p>  <p>SAE Code 61 Flange 90° Elbow ISO 12151-3-E-L – SFL 90° 5000 psi</p>	<p><b>6A</b> Di-3</p>  <p>SAE Code 62 Flange Straight ISO 12151-3-S-S – SFS 6000 psi</p>
<p><b>6F</b> Di-3</p>  <p>SAE Code 62 Flange 45° Elbow – Heavy Series ISO 12151-3 – E45-S – SFS 45° 6000 psi</p>	<p><b>6N</b> Di-3</p>  <p>SAE Code 62 Flange 90° Elbow ISO 12151-3 – E-S – SFS 90° 6000 psi</p>		

# 01

## Male NPTF Pipe Rigid – Straight

SAE J476A / J516 – AGN

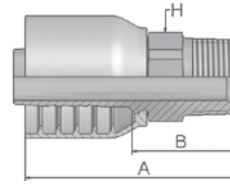

XXXXX-XX-XX Part Number S6	Hose I.D.				Thread NPTF	A mm	B mm	H mm
	DN	Inch	Size	mm				
101S6-32-32	50	2	-32	50.8	2x11-1/2	150	62	2-1/2

# 06

## Female JIC 37° – Swivel Straight

ISO12151-5-SWS – DKJ

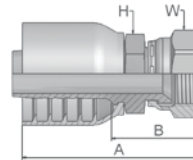

XXXXX-XX-XX Part Number S6	Hose I.D.				Thread UNF	A mm	B mm	H mm Inch	W mm Inch
	DN	Inch	Size	mm					
106S6-32-32	50	2	-32	50.8	2-1/2x12	166	78	2/1/2	2-7/8

Approved **fitting series** for hose types:

**S6** P35

## 4A SAE Code 61 Flange Straight

ISO 12151-3-S-L – SFL  
5000 psi

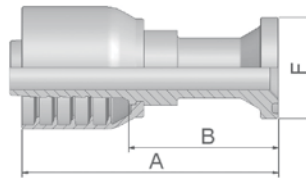

XXXXX-XX-XX Part Number S6	Hose I.D.				Flange	A mm	B mm	F mm
	DN	Inch	Size	mm				
14AS6-32-32	50	2	-32	50.8	2	171	83	71

## 4F SAE Code 61 Flange 45° Elbow

ISO 12151-3 – E45S – L – SFL 45°  
5000 psi

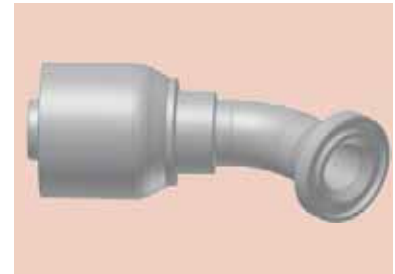
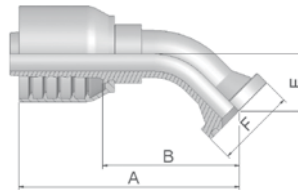

XXXXX-XX-XX Part Number S6	Hose I.D.				Flange	A mm	B mm	E mm	F mm
	DN	Inch	Size	mm					
14FS6-32-32	50	2	-32	50.8	2	229	141	56	71

## 4N SAE Code 61 Flange 90° Elbow

ISO 12151-3-E-L – SFL 90°  
5000 psi

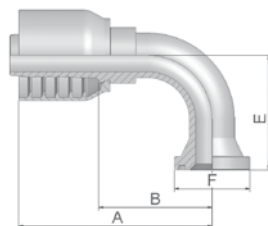

XXXXX-XX-XX Part Number S6	Hose I.D.				Flange	A mm	B mm	E mm	F mm
	DN	Inch	Size	mm					
14NS6-32-32	50	2	-32	50.8	2	214	126	138	71

Find SAE flange halves in section Eb.

Fittings with standard O-ring seals can be used for temperatures from -30 °C up to +105 °C.

Find O-rings in section E. Special O-rings are available on request.

Approved **fitting series** for hose types:

**S6** P35



## 6A SAE Code 62 Flange Straight

ISO 12151-3-S-S – SFS  
6000 psi

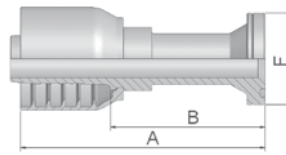

XXXXX-XX-XX Part Number S6	Hose I.D.				Flange	A mm	B mm	F mm
	DN	Inch	Size	mm				
16AS6-32-32	50	2	-32	50.8	2	209	121	79

## 6F SAE Code 62 Flange 45° Elbow – Heavy Series

ISO 12151-3 – E45-S – SFS 45°  
6000 psi

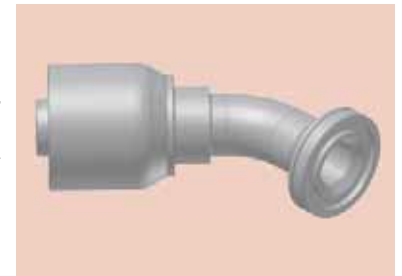
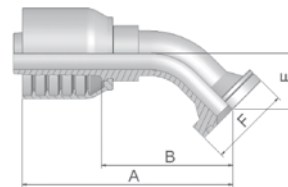

XXXXX-XX-XX Part Number S6	Hose I.D.				Flange	A mm	B mm	E mm	F mm
	DN	Inch	Size	mm					
16FS6-32-32	50	2	-32	50.8	2	229	141	56	79

## 6N SAE Code 62 Flange 90° Elbow

ISO 12151-3 – E-S – SFS 90°  
6000 psi

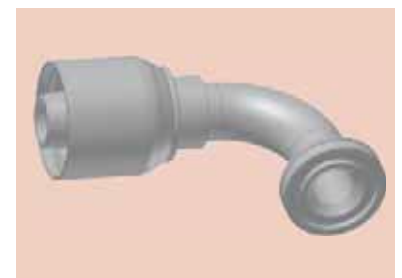
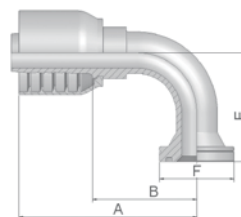

XXXXX-XX-XX Part Number S6	Hose I.D.				Flange	A mm	B mm	E mm	F mm
	DN	Inch	Size	mm					
16NS6-32-32	50	2	-32	50.8	2	214	126	138	79

Find SAE flange halves in section Eb.







Fittings with standard O-ring seals can be used for temperatures from -30 °C up to +105 °C.

Find O-rings in section E. Special O-rings are available on request.





Approved **fitting series** for hose types:

**S6** P35





## DIN – Metric

Page Dj-2 – Dj-5			
<p><b>CA</b> Dj-2</p>  <p>Female Metric 24° Light Series with O-Ring Swivel – Straight ISO 12151-2-SWS-L – DKOL</p>	<p><b>CE</b> Dj-2</p>  <p>Female Metric 24° Light Series with O-Ring Swivel – 45° Elbow ISO 12151-2-SWE 45°-L – DKOL 45°</p>	<p><b>CF</b> Dj-3</p>  <p>Female Metric 24° Light Series with O-Ring Swivel – 90° Elbow ISO 12151-2-SWE-L – DKOL 90°</p>	<p><b>C9</b> Dj-3</p>  <p>Female Metric 24° – Swivel Heavy Series with O-Ring Straight ISO 12151-2-SWS-S – DKOS</p>
<p><b>0C</b> Dj-4</p>  <p>Female Metric 24° – Swivel Heavy Series with O-Ring 45° Elbow ISO 12151-2 – SWE 45°-S – DKOS 45°</p>	<p><b>1C</b> Dj-4</p>  <p>Female Metric 24° – Swivel Heavy Series with O-Ring 90° Elbow ISO 12151-2-SWE-S – DKOS 90°</p>	<p><b>D2</b> Dj-5</p>  <p>Male Metric 24° – Rigid Heavy Series – Straight ISO 12151-2-S-S – CES</p>	







## BSP

Page Dj-6 – Dj-7			
<p><b>92</b> Dj-6</p>  <p>Female BSP Parallel Pipe Swivel – Straight (60° Cone) BS5200-A – DKR</p>	<p><b>B1</b> Dj-6</p>  <p>Female BSP Parallel Pipe Swivel 45° Elbow (60° Cone) BS 5200-D – DKR 45°</p>	<p><b>B2</b> Dj-7</p>  <p>Female BSP Parallel Pipe Swivel 90° Elbow (60° Cone) BS 5200-B – DKR 90°</p>	<p><b>D9</b> Dj-7</p>  <p>Male BSP Parallel Pipe Rigid – Straight (60° Cone) BS5200 – AGR</p>



## SAE

Page Dj-8 – Dj-10			
<p><b>01</b> Dj-8</p>  <p>Male NPTF Pipe Rigid – Straight SAE J476A / J516 – AGN</p>	<p><b>03</b> Dj-8</p>  <p>Male JIC 37° – Rigid Straight ISO12151-5-S – AGJ</p>	<p><b>06/68</b> Dj-9</p>  <p>Female – JIC 37° SAE 45° Dual Flare Swivel – Straight ISO12151-5-SWS – DKJ</p>	<p><b>37/3V</b> Dj-9</p>  <p>Female JIC 37° SAE 45° – Dual Flare Swivel Female 45° Elbow ISO 12151-5-SWE 45° – DKJ 45°</p>
<p><b>39/3W</b> Dj-10</p>  <p>Female JIC 37° SAE 45° – Dual Flare Swivel Female 90° Elbow ISO 12151-5-SWES – DKJ 90°</p>			



## Flange

Page Dj-11 – Dj-13			
<p><b>15</b> Dj-11</p>  <p>SAE Code 61 – Flange Head Straight ISO 12151-3-S-L – SFL 3000 psi</p>	<p><b>17</b> Dj-11</p>  <p>SAE Code 61 – Flange Head 45° Elbow ISO 12151-3 – E45 – L – SFL 45° 3000 psi</p>	<p><b>19</b> Dj-12</p>  <p>SAE Code 61 – Flange Head 90° Elbow ISO 12151-3 – E – L – SFL 90° 3000 psi</p>	<p><b>6A</b> Dj-12</p>  <p>SAE Code 62 Flange Straight ISO 12151-3-S-S – SFS 6000 psi</p>
<p><b>6F</b> Dj-13</p>  <p>SAE Code 62 Flange 45° Elbow – Heavy Series ISO 12151-3 – E45-S – SFS 45° 6000 psi</p>	<p><b>6N</b> Dj-13</p>  <p>SAE Code 62 Flange 90° Elbow ISO 12151-3 – E-S – SFS 90° 6000 psi</p>		

## ORFS

Page Dj-14 – Dj-15		
<p><b>JC</b> Dj-14</p>  <p>Female ORFS Swivel – Straight Short ISO 12151-1 – SWSA SAE J516 – ORFS</p>	<p><b>J7</b> Dj-14</p>  <p>Female ORFS – Swivel 45° Elbow ISO 12151-1 – SWE 45° SAE J516 – ORFS 45°</p>	<p><b>J9</b> Dj-15</p>  <p>Female ORFS – Swivel 90° Elbow – Short Drop ISO 12151-1 – SWES SAE J516 – ORFS 90°</p>

## French Standard

Page Dj-16	
<p><b>FG</b> Dj-16</p>  <p>Male French Gas Series Rigid – Straight (24° Cone)</p>	<p><b>F4</b> Dj-16</p>  <p>Female French Gas Series Swivel – Straight (Ball Nose)</p>



**VS**

**Interlock  
Outside Skive**



**Only for use with  
adjustable crimpers.**

XXXXX-XX-XX Part Number	 Hose I.D.				B mm
	DN	Inch	Size	mm	
100VS-4	6	1/4	-4	6.3	38
100VS-6	10	3/8	-6	9.5	36
100VS-8	12	1/2	-8	12.7	41

Approved **fitting series** for hose types:

<b>VS</b>   -4 up to -8   H31   H31TC   H31ST
---

## CA Female Metric 24° Light Series with O-Ring Swivel – Straight

ISO 12151-2-SWS-L – DKOL

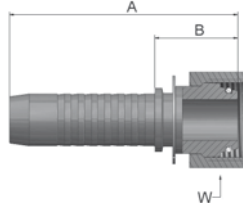

XXXXX-XX-XX Part Number VS	Hose I.D.				Thread metric	Tube O.D. mm	A mm	B mm	W mm
	DN	Inch	Size	mm					
KCAVS-10-6	10	3/8	-6	9.5	M16x1.5	10	64	25	19
KCAVS-12-6	10	3/8	-6	9.5	M18x1.5	12	61	23	22
KCAVS-15-8	12	1/2	-8	12.7	M22x1.5	15	70	27	27

Fittings with standard O-ring seals can be used for temperatures from -30 °C up to +105 °C.  
Find O-rings in section E. Special O-rings are available on request.

## CE Female Metric 24° Light Series with O-Ring Swivel – 45° Elbow

ISO 12151-2-SWE 45°-L – DKOL 45°

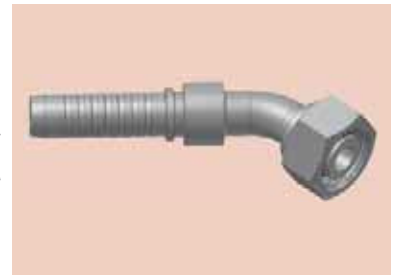
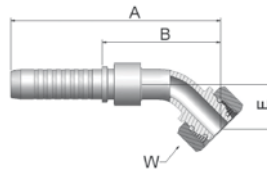

XXXXX-XX-XX Part Number VS	Hose I.D.				Thread metric	Tube O.D. mm	A mm	B mm	E mm	W mm
	DN	Inch	Size	mm						
KCEVS-12-6	10	3/8	-6	9.5	M18x1.5	12	93	55	19	22
KCEVS-15-8	12	1/2	-8	12.7	M22x1.5	15	103	61	23	27

Fittings with standard O-ring seals can be used for temperatures from -30 °C up to +105 °C.  
Find O-rings in section E. Special O-rings are available on request.

Approved **fitting series** for hose types:

VS | -4 up to -8 H31 H31TC H31ST |

## CF Female Metric 24° Light Series with O-Ring Swivel – 90° Elbow

ISO 12151-2-SWE-L – DKOL 90°

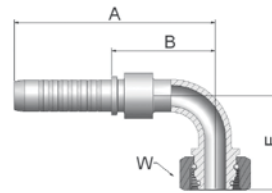

XXXXX-XX-XX Part Number VS	Hose I.D.				Thread metric	Tube O.D. mm	A mm	B mm	E mm	W mm
	DN	Inch	Size	mm						
KCFVS-10-6	10	3/8	-6	9.5	M16x1.5	10	82	44	37	19
KCFVS-12-6	10	3/8	-6	9.5	M18x1.5	12	83	45	36	22
KCFVS-15-8	12	1/2	-8	12.7	M22x1.5	15	92	50	44	27

Fittings with standard O-ring seals can be used for temperatures from -30 °C up to +105 °C.  
Find O-rings in section E. Special O-rings are available on request.

## C9 Female Metric 24° – Swivel Heavy Series with O-Ring Straight

ISO 12151-2-SWS-S – DKOS

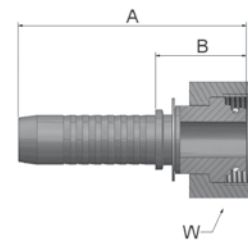

XXXXX-XX-XX Part Number VS	Hose I.D.				Thread metric	Tube O.D. mm	A mm	B mm	W mm
	DN	Inch	Size	mm					
KC9VS-8-4	6	1/4	-4	6.3	M16x1.5	8	61	23	19
KC9VS-10-4	6	1/4	-4	6.3	M18x1.5	10	62	24	22
KC9VS-8-6	10	3/8	-6	9.5	M16x1.5	8	64	25	19
KC9VS-12-6	10	3/8	-6	9.5	M20x1.5	12	63	25	24
KC9VS-14-6	10	3/8	-6	9.5	M22x1.5	14	63	24	27
KC9VS-12-8	12	1/2	-8	12.7	M20x1.5	12	70	28	24
KC9VS-16-8	12	1/2	-8	12.7	M24x1.5	16	71	29	30
KC9VS-20-8	12	1/2	-8	12.7	M30x2	20	71	29	36

Fittings with standard O-ring seals can be used for temperatures from -30 °C up to +105 °C.  
Find O-rings in section E. Special O-rings are available on request.

Approved **fitting series** for hose types:

VS | -4 up to -8 H31 H31TC H31ST |

## 0C Female Metric 24° – Swivel Heavy Series with O-Ring 45° Elbow

ISO 12151-2 – SWE 45°-S – DKOS 45°

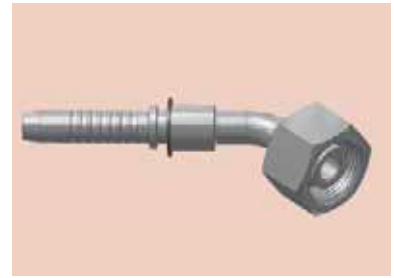
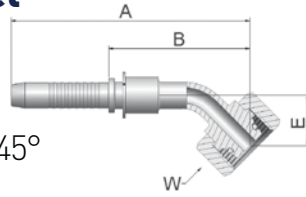

XXXXX-XX-XX Part Number VS	Hose I.D.				Thread metric	Tube O.D. mm	A mm	B mm	E mm	W mm
	DN	Inch	Size	mm						
K0CVS-8-4	6	1/4	-4	6.3	M16x1.5	8	88	50	16	19
K0CVS-10-4	6	1/4	-4	6.3	M18x1.5	10	88	50	16	22
K0CVS-12-6	10	3/8	-6	9.5	M20x1.5	12	94	56	20	24
K0CVS-14-6	10	3/8	-6	9.5	M22x1.5	14	94	56	20	27
K0CVS-16-8	12	1/2	-8	12.7	M24x1.5	16	105	62	24	30
K0CVS-20-8	12	1/2	-8	12.7	M30x2	20	106	63	25	36

Fittings with standard O-ring seals can be used for temperatures from -30 °C up to +105 °C.  
Find O-rings in section E. Special O-rings are available on request.

## 1C Female Metric 24° – Swivel Heavy Series with O-Ring 90° Elbow

ISO 12151-2-SWE-S – DKOS 90°

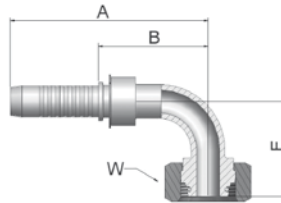

XXXXX-XX-XX Part Number VS	Hose I.D.				Thread metric	Tube O.D. mm	A mm	B mm	E mm	W mm
	DN	Inch	Size	mm						
K1CVS-8-4	6	1/4	-4	6.3	M16x1.5	8	79	41	29	19
K1CVS-10-4	6	1/4	-4	6.3	M18x1.5	10	79	41	29	22
K1CVS-12-6	10	3/8	-6	9.5	M20x1.5	12	83	45	37	24
K1CVS-14-6	10	3/8	-6	9.5	M22x1.5	14	83	45	37	27
K1CVS-16-8	12	1/2	-8	12.7	M24x1.5	16	93	51	45	30

Fittings with standard O-ring seals can be used for temperatures from -30 °C up to +105 °C.  
Find O-rings in section E. Special O-rings are available on request.

Approved **fitting series** for hose types:

VS | -4 up to -8 H31 H31TC H31ST |



## D2

### Male Metric 24° – Rigid Heavy Series – Straight

ISO 12151-2-S-S – CES

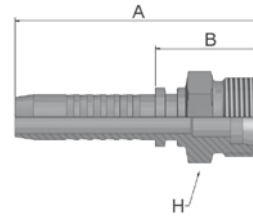

XXXXX-XX-XX Part Number VS	Hose I.D.				Thread metric	Tube O.D. mm	A mm	B mm	H mm
	DN	Inch	Size	mm					
KD2VS-12-6	10	3/8	-6	9.5	M20x1.5	12	66	27	22
KD2VS-14-6	10	3/8	-6	9.5	M22x1.5	14	68	30	22
KD2VS-16-8	12	1/2	-8	12.7	M24x1.5	16	74	31	24

Fittings with standard O-ring seals can be used for temperatures from -30 °C up to +105 °C.  
Find O-rings in section E. Special O-rings are available on request.

Approved **fitting series** for hose types:

VS | -4 up to -8 H31 H31TC H31ST |

## 92 Female BSP Parallel Pipe Swivel – Straight (60° Cone)

BS5200-A – DKR

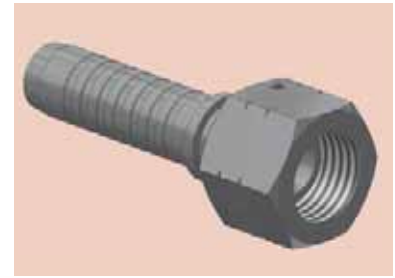
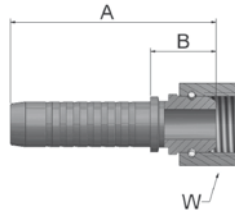

XXXXX-XX-XX Part Number VS	Hose I.D.				Thread BSP	A mm	B mm	W mm
	DN	Inch	Size	mm				
K92VS-6-6	10	3/8	-6	9.5	3/8x19	60	22	22
K92VS-8-6	10	3/8	-6	9.5	1/2x14	62	23	27
K92VS-8-8	12	1/2	-8	12.7	1/2x14	67	24	27
K92VS-10-8	12	1/2	-8	12.7	5/8x14	65	23	30

## B1 Female BSP Parallel Pipe Swivel 45° Elbow (60° Cone)

BS 5200-D – DKR 45°

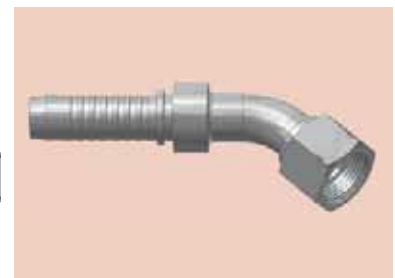
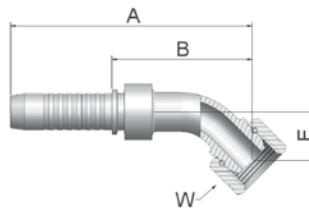

XXXXX-XX-XX Part Number VS	Hose I.D.				Thread BSP	A mm	B mm	E mm	W mm
	DN	Inch	Size	mm					
KB1VS-6-6	10	3/8	-6	9.5	3/8x19	90	52	17	22
KB1VS-8-6	10	3/8	-6	9.5	1/2x14	91	53	17	27
KB1VS-8-8	12	1/2	-8	12.7	1/2x14	100	58	20	27
KB1VS-10-8	12	1/2	-8	12.7	5/8x14	99	57	19	30

Approved **fitting series** for hose types:

VS | -4 up to -8 H31 H31TC H31ST |

## B2 Female BSP Parallel Pipe Swivel 90° Elbow (60° Cone)

BS 5200-B – DKR 90°

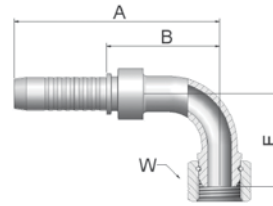

XXXXX-XX-XX Part Number VS	Hose I.D.				Thread BSP	A mm	B mm	E mm	W mm
	DN	Inch	Size	mm					
KB2VS-6-6	10	3/8	-6	9.5	3/8x19	82	44	33	22
KB2VS-8-6	10	3/8	-6	9.5	1/2x14	83	45	36	27
KB2VS-8-8	12	1/2	-8	12.7	1/2x14	92	50	40	27
KB2VS-10-8	12	1/2	-8	12.7	5/8x14	92	50	38	30

## D9 Male BSP Parallel Pipe Rigid – Straight (60° Cone)

BS5200 – AGR

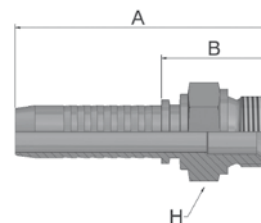

XXXXX-XX-XX Part Number VS	Hose I.D.				Thread BSP	A mm	B mm	H mm
	DN	Inch	Size	mm				
KD9VS-6-6	10	3/8	-6	9.5	3/8x19	71	33	22
KD9VS-8-8	12	1/2	-8	12.7	1/2x14	78	36	27

Approved **fitting series** for hose types:

VS | -4 up to -8 H31 H31TC H31ST |

# 01 Male NPTF Pipe Rigid – Straight

SAE J476A / J516 – AGN

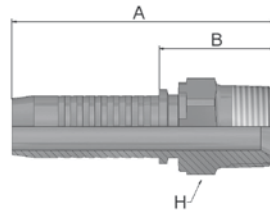

XXXXX-XX-XX Part Number VS	Hose I.D.				Thread NPTF	A mm	B mm	H mm
	DN	Inch	Size	mm				
K01VS-6-6	10	3/8	-6	9.5	3/8x18	71	33	19
K01VS-8-8	12	1/2	-8	12.7	1/2x14	83	40	22

# 03 Male JIC 37° – Rigid Straight

ISO12151-5-S – AGJ

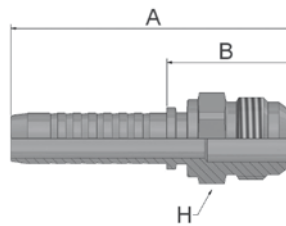

XXXXX-XX-XX Part Number VS	Hose I.D.				Thread UNF	A mm	B mm	H mm
	DN	Inch	Size	mm				
K03VS-6-6	10	3/8	-6	9.5	9/16x18	71	32	19
K03VS-8-6	10	3/8	-6	9.5	3/4x16	69	31	22
K03VS-8-8	12	1/2	-8	12.7	3/4x16	79	36	22
K03VS-10-8	12	1/2	-8	12.7	7/8x14	77	35	24

Approved **fitting series** for hose types:

VS | -4 up to -8 H31 H31TC H31ST |

# 06/68 Female – JIC 37° SAE 45° Dual Flare Swivel – Straight

ISO12151-5-SWS – DKJ

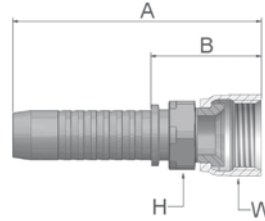

XXXXX-XX-XX Part Number VS	Hose I.D.				Thread UNF	A mm	B mm	H mm	W mm
	DN	Inch	Size	mm					
K68VS-4-4	6	1/4	-4	6.3	7/16x20	66	28	14	17
K06VS-6-4	6	1/4	-4	6.3	9/16x18	71	32	14	19
K06VS-6-6	10	3/8	-6	9.5	9/16x18	69	31	17	19
K68VS-8-6	10	3/8	-6	9.5	3/4x16	74	35	17	22
K06VS-12-6	10	3/8	-6	9.5	1-1/16x12	78	40	27	32
K68VS-12-6	10	3/8	-6	9.5	1-1/16x12	64	25	27	32
K68VS-8-8	12	1/2	-8	12.7	3/4x16	77	35	22	22
K68VS-10-8	12	1/2	-8	12.7	7/8x14	83	41	22	27
K06VS-12-8	12	1/2	-8	12.7	1-1/16x12	83	41	27	32
K68VS-12-8	12	1/2	-8	12.7	1-1/16x12	69	27	27	32

# 37/3V Female JIC 37° SAE 45° – Dual Flare Swivel Female 45° Elbow

ISO 12151-5-SWE 45° – DKJ 45°

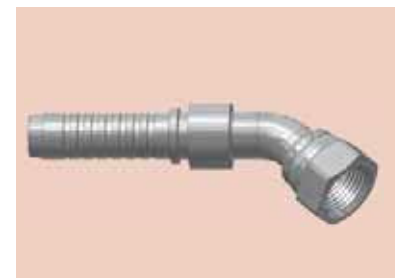
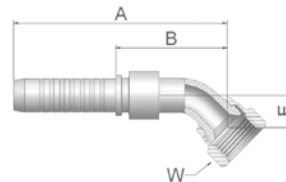

XXXXX-XX-XX Part Number VS	Hose I.D.				Thread UNF	A mm	B mm	E mm	W mm
	DN	Inch	Size	mm					
K37VS-6-4	6	1/4	-4	6.3	9/16x18	83	44	11	19
K37VS-6-6	10	3/8	-6	9.5	9/16x18	83	45	11	19
K3VS-8-6	10	3/8	-6	9.5	3/4x16	87	49	15	22
K3VS-8-8	12	1/2	-8	12.7	3/4x16	93	51	15	22
K3VS-10-8	12	1/2	-8	12.7	7/8x14	94	52	16	27
K37VS-12-8	12	1/2	-8	12.7	1-1/16x12	99	57	21	32
K3VS-12-8	12	1/2	-8	12.7	1-1/16x12	99	57	21	32

Approved fitting series for hose types:

VS | -4 up to -8 H31 H31TC H31ST |

**39/3W Female JIC 37°  
SAE 45° – Dual Flare  
Swivel Female 90° Elbow**

ISO 12151-5-SWES – DKJ 90°

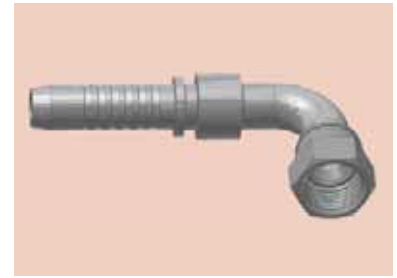
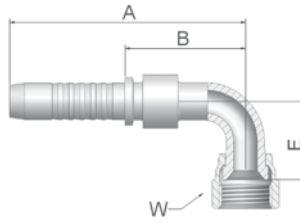

XXXXX-XX-XX Part Number VS	Hose I.D.				Thread UNF	A mm	B mm	E mm	W mm
	DN	Inch	Size	mm					
K39VS-6-4	6	1/4	-4	6.3	9/16x18	77	39	23	19
K39VS-6-6	10	3/8	-6	9.5	9/16x18	80	42	23	19
K3WVS-8-6	10	3/8	-6	9.5	3/4x16	80	42	29	22
K3WVS-8-8	12	1/2	-8	12.7	3/4x16	87	45	29	22
K3WVS-10-8	12	1/2	-8	12.7	7/8x14	87	45	32	27

Approved **fitting series** for hose types:

VS | -4 up to -8 H31 H31TC H31ST |

# 15 SAE Code 61 – Flange Head Straight

ISO 12151-3-S-L – SFL  
3000 psi

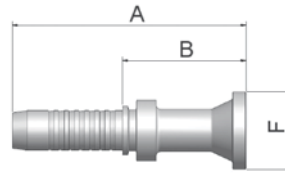

XXXXX-XX-XX Part Number VS	Hose I.D.				Flange	A mm	B mm	F mm
	DN	Inch	Size	mm				
K15VS-8-8	12	1/2	-8	12.7	1/2	102	59	30
K15VS-12-8	12	1/2	-8	12.7	3/4	77	34	38

Find SAE flange halves in section Eb.

# 17 SAE Code 61 – Flange Head 45° Elbow

ISO 12151-3 – E45 – L – SFL 45°  
3000 psi

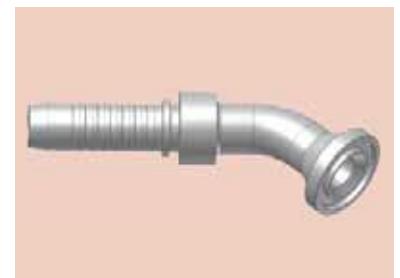
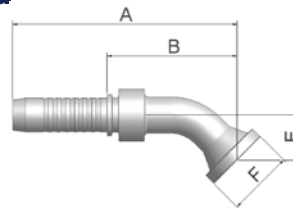

XXXXX-XX-XX Part Number VS	Hose I.D.				Flange	A mm	B mm	E mm	F mm
	DN	Inch	Size	mm					
K17VS-8-8	12	1/2	-8	12.7	1/2	100	57	20	30
K17VS-12-8	12	1/2	-8	12.7	3/4	101	58	21	38

Find SAE flange halves in section Eb.

Approved **fitting series** for hose types:

VS | -4 up to -8 | H31 | H31TC | H31ST |

## 19 SAE Code 61 – Flange Head 90° Elbow

ISO 12151-3 – E– L – SFL 90°  
3000 psi

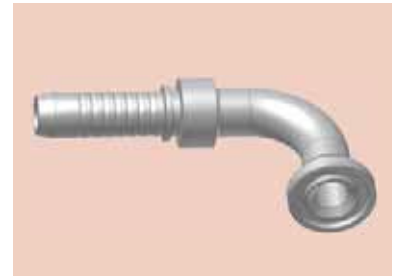
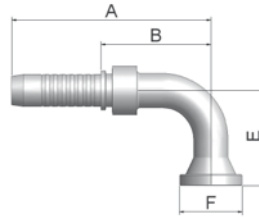

XXXXX-XX-XX Part Number VS	Hose I.D.				Flange	A mm	B mm	E mm	F mm
	DN	Inch	Size	mm					
K19VS-8-8	12	1/2	-8	12.7	1/2	92	50	41	30
K19VS-12-8	12	1/2	-8	12.7	3/4	92	50	42	38

Find SAE flange halves in section Eb.

## 6A SAE Code 62 Flange Straight

ISO 12151-3-S-S – SFS  
6000 psi

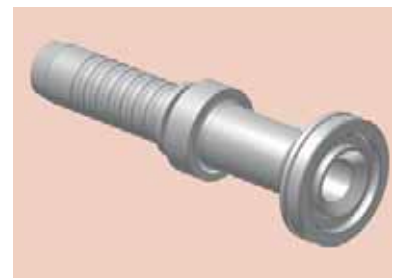
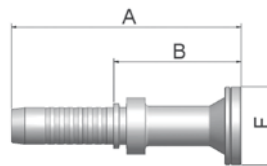

XXXXX-XX-XX Part Number VS	Hose I.D.				Flange	A mm	B mm	F mm
	DN	Inch	Size	mm				
K6AVS-8-8	12	1/2	-8	12.7	1/2	105	63	32
K6AVS-12-8	12	1/2	-8	12.7	3/4	79	36	41

Find SAE flange halves in section Eb.

Approved **fitting series** for hose types:

VS | -4 up to -8 H31 H31TC H31ST |



## 6F SAE Code 62 Flange 45° Elbow – Heavy Series

ISO 12151-3 – E45-S – SFS 45°  
6000 psi

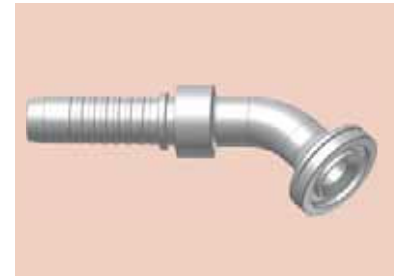
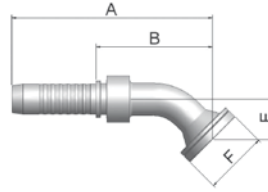

XXXXX-XX-XX Part Number VS	Hose I.D.				Flange	A mm	B mm	E mm	F mm
	DN	Inch	Size	mm					
K6FVS-8-8	12	1/2	-8	12.7	1/2	94	52	19	32
K6FVS-12-8	12	1/2	-8	12.7	3/4	106	64	26	41

Find SAE flange halves in section Eb.

## 6N SAE Code 62 Flange 90° Elbow

ISO 12151-3 – E-S – SFS 90°  
6000 psi

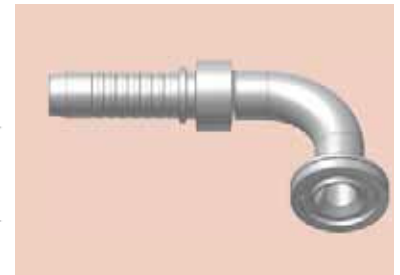
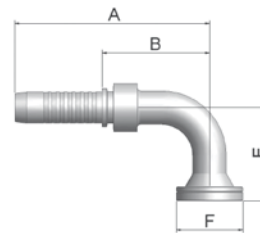

XXXXX-XX-XX Part Number VS	Hose I.D.				Flange	A mm	B mm	E mm	F mm
	DN	Inch	Size	mm					
K6NVS-8-8	12	1/2	-8	12.7	1/2	87	45	41	32
K6NVS-12-8	12	1/2	-8	12.7	3/4	92	50	45	41

Find SAE flange halves in section Eb.

Approved **fitting series** for hose types:

VS | -4 up to -8 H31 H31TC H31ST |

## JC Female ORFS Swivel – Straight Short

ISO 12151-1 – SWSA  
SAE J516 – ORFS

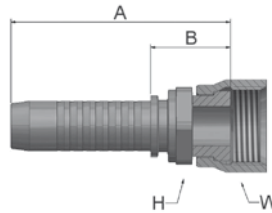

XXXXX-XX-XX Part Number VS	Hose I.D.				Thread UNF	A mm	B mm	H mm	W mm
	DN	Inch	Size	mm					
KJCVS-4-4	6	1/4	-4	6.3	9/16x18	62	23	14	17
KJCVS-6-6	10	3/8	-6	9.5	11/16x16	60	22	17	22
KJCVS-8-6	10	3/8	-6	9.5	13/16x16	62	23	19	24
KJCVS-8-8	12	1/2	-8	12.7	13/16x16	67	24	22	24
KJCVS-10-8	12	1/2	-8	12.7	1x14	69	26	24	30

## J7 Female ORFS – Swivel 45° Elbow

ISO 12151-1 – SWE 45°  
SAE J516 – ORFS 45°

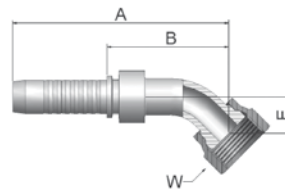

XXXXX-XX-XX Part Number VS	Hose I.D.				Thread UNF	A mm	B mm	E mm	W mm
	DN	Inch	Size	mm					
KJ7VS-4-4	6	1/4	-4	6.3	9/16x18	82	43	10	17
KJ7VS-6-6	10	3/8	-6	9.5	11/16x16	83	45	11	22
KJ7VS-8-6	10	3/8	-6	9.5	13/16x16	89	51	15	24
KJ7VS-8-8	12	1/2	-8	12.7	13/16x16	93	51	15	24
KJ7VS-10-8	12	1/2	-8	12.7	1x14	95	53	16	30

Approved **fitting series** for hose types:

VS | -4 up to -8 H31 H31TC H31ST |

# J9

## Female ORFS – Swivel 90° Elbow – Short Drop

ISO 12151-1 – SWES  
SAE J516 – ORFS 90°

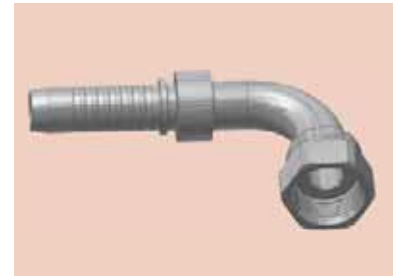
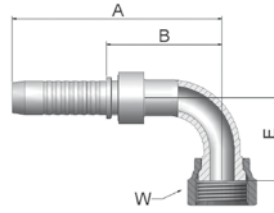

XXXXX-XX-XX Part Number VS	Hose I.D.				Thread UNF	A mm	B mm	E mm	W mm
	DN	Inch	Size	mm					
KJ9VS-4-4	6	1/4	-4	6.3	9/16x18	77	39	21	17
KJ9VS-6-6	10	3/8	-6	9.5	11/16x16	80	42	23	22
KJ9VS-8-6	10	3/8	-6	9.5	13/16x16	83	45	29	24
KJ9VS-8-8	12	1/2	-8	12.7	13/16x16	87	45	29	24
KJ9VS-10-8	12	1/2	-8	12.7	1x14	88	46	32	30
KJ9VS-12-8	12	1/2	-8	12.7	1-3/16x12	88	46	48	36

Approved **fitting series** for hose types:

VS | -4 up to -8 H31 H31TC H31ST |

## FG Male French Gas Series Rigid – Straight (24° Cone)

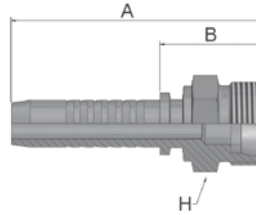

XXXXX-XX-XX Part Number VS	Hose I.D.				Thread metric	Tube O.D. mm	A mm	B mm	H mm
	DN	Inch	Size	mm					
KFGVS-13-6	10	3/8	-6	9.5	M20x1.5	13.25	69	31	22
KFGVS-17-8	12	1/2	-8	12.7	M24x1.5	16.75	72	30	24

## F4 Female French Gas Series Swivel – Straight (Ball Nose)

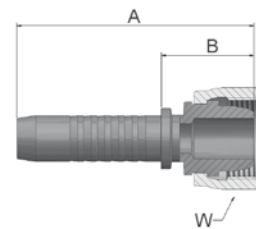







XXXXX-XX-XX Part Number VS	Hose I.D.				Thread metric	Tube O.D. mm	A mm	B mm	W mm
	DN	Inch	Size	mm					
KF4VS-13-6	10	3/8	-6	9.5	M20x1.5	13.25	62	24	24
KF4VS-17-8	12	1/2	-8	12.7	M24x1.5	16.75	70	27	30

Approved **fitting series** for hose types:



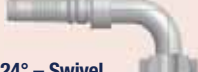

VS | -4 up to -8 H31 H31TC H31ST |







## DIN – Metric

Page Dk-2 – Dk-5			
<p><b>CA</b> Dk-2</p>  <p>Female Metric 24° Light Series with O-Ring Swivel – Straight ISO 12151-2-SWS-L – DKOL</p>	<p><b>CE</b> Dk-2</p>  <p>Female Metric 24° Light Series with O-Ring Swivel – 45° Elbow ISO 12151-2-SWE 45°-L – DKOL 45°</p>	<p><b>CF</b> Dk-3</p>  <p>Female Metric 24° Light Series with O-Ring Swivel – 90° Elbow ISO 12151-2-SWE-L – DKOL 90°</p>	<p><b>C9</b> Dk-4</p>  <p>Female Metric 24° – Swivel Heavy Series with O-Ring Straight ISO 12151-2-SWS-S – DKOS</p>
<p><b>OC</b> Dk-4</p>  <p>Female Metric 24° – Swivel Heavy Series with O-Ring 45° Elbow ISO 12151-2 – SWE 45°-S – DKOS 45°</p>	<p><b>1C</b> Dk-5</p>  <p>Female Metric 24° – Swivel Heavy Series with O-Ring 90° Elbow ISO 12151-2-SWE-S – DKOS 90°</p>	<p><b>D2</b> Dk-5</p>  <p>Male Metric 24° – Rigid Heavy Series – Straight ISO 12151-2-S-S – CES</p>	

















## BSP

Page Dk-6 – Dk-8			
<p><b>92</b> Dk-6</p>  <p>Female BSP Parallel Pipe Swivel – Straight (60° Cone) BS5200-A – DKR</p>	<p><b>B1</b> Dk-6</p>  <p>Female BSP Parallel Pipe Swivel 45° Elbow (60° Cone) BS 5200-D – DKR 45°</p>	<p><b>B2</b> Dk-7</p>  <p>Female BSP Parallel Pipe Swivel 90° Elbow (60° Cone) BS 5200-B – DKR 90°</p>	<p><b>D9</b> Dk-7</p>  <p>Male BSP Parallel Pipe Rigid – Straight (60° Cone) BS5200 – AGR</p>
<p><b>91</b> Dk-8</p>  <p>Male BSP Taper Pipe – Rigid Straight BS5200 – AGR-K</p>			



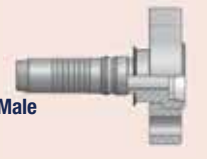

## SAE

Page Dk-9 – Dk-11			
<p><b>01</b> Dk-9</p>  <p>Male NPTF Pipe Rigid – Straight SAE J476A / J516 – AGN</p>	<p><b>03</b> Dk-9</p>  <p>Male JIC 37° – Rigid Straight ISO12151-5-S – AGJ</p>	<p><b>06</b> Dk-10</p>  <p>Female JIC 37° – Swivel Straight ISO12151-5-SWS – DKJ</p>	<p><b>37</b> Dk-10</p>  <p>Female JIC 37° – Swivel 45° Elbow ISO 12151-5-SWE 45° – DKJ 45°</p>
<p><b>39</b> Dk-11</p>  <p>Female JIC 37° – Swivel 90° Elbow ISO 12151-5-SWES – DKJ 90°</p>			



## Flange

Page Dk-12 – Dk-22 and Dk-27 – Dk-28			
<p><b>15/4A</b> <b>Dk-12</b></p>  <p>SAE Code 61 Flange Straight ISO 12151-3-S-L – SFL 5000 psi</p>	<p><b>17/4F</b> <b>Dk-13</b></p>  <p>SAE Code 61 Flange 45° Elbow ISO 12151-3 – E45S – L – SFL 45° 5000 psi</p>	<p><b>19/4N</b> <b>Dk-14</b></p>  <p>SAE Code 61 Flange 90° Elbow ISO 12151-3-E-L – SFL 90° 5000 psi</p>	<p><b>6A</b> <b>Dk-15</b></p>  <p>SAE Code 62 Flange Straight ISO 12151-3-S-S – SFS 6000 psi</p>
<p><b>6F</b> <b>Dk-16</b></p>  <p>SAE Code 62 Flange 45° Elbow – Heavy Series ISO 12151-3 – E45-S – SFS 45° 6000 psi</p>	<p><b>6N</b> <b>Dk-17</b></p>  <p>SAE Code 62 Flange 90° Elbow ISO 12151-3 – E-S – SFS 90° 6000 psi</p>	<p><b>8A</b> <b>Dk-27</b></p>  <p>Flange – Straight 8000 psi</p>	<p><b>8F</b> <b>Dk-27</b></p>  <p>Flange – 45° Elbow 8000 psi</p>
<p><b>8N</b> <b>Dk-28</b></p>  <p>Flange – 90° Elbow 8000 psi</p>	<p><b>X5</b> <b>Dk-19</b> <b>Dk-29</b></p>  <p>Flange – Straight Full flange system for Code 61 or Code 62</p>	<p><b>X7</b> <b>Dk-19</b></p>  <p>Flange – 45° Elbow Full flange system for Code 61 or Code 62</p>	<p><b>X9</b> <b>Dk-20</b></p>  <p>Flange – 90° Elbow Full flange system for Code 61 or Code 62</p>
<p><b>PY</b> <b>Dk-20</b></p>  <p>Flange – 24° Male French Gas Straight</p>	<p><b>XA</b> <b>Dk-21</b></p>  <p>Caterpillar® Flange Straight</p>	<p><b>XF</b> <b>Dk-21</b></p>  <p>Caterpillar® Flange 45° Elbow</p>	<p><b>XG</b> <b>Dk-22</b></p>  <p>Caterpillar® Flange 60° Elbow</p>
<p><b>XN</b> <b>Dk-22</b></p>  <p>Caterpillar® Flange 90° Elbow</p>			



## ORFS

Page Dk-23 – Dk-25			
<p><b>JC</b> <b>Dk-23</b></p>  <p>Female ORFS Swivel – Straight Short ISO 12151-1 – SWSA SAE J516 – ORFS</p>	<p><b>JS</b> <b>Dk-24</b></p>  <p>ORFS Swivel Female (Long) ISO 12151-1-SWSB SAE J516 – ORFS</p>	<p><b>J7</b> <b>Dk-24</b></p>  <p>Female ORFS – Swivel 45° Elbow ISO 12151-1 – SWE 45° SAE J516 – ORFS 45°</p>	<p><b>J9</b> <b>Dk-25</b></p>  <p>Female ORFS – Swivel 90° Elbow – Short Drop ISO 12151-1 – SWES SAE J516 – ORFS 90°</p>
<p><b>JM</b> <b>Dk-25</b></p>  <p>ORFS Male ISO 12151-1-S – SAE J516</p>			

## French Standard

Page Dk-26	
<p><b>FG</b> <b>Dk-26</b></p>  <p>Male French Gas Series Rigid – Straight (24° Cone)</p>	<p><b>F4</b> <b>Dk-26</b></p>  <p>Female French Gas Series Swivel – Straight (Ball Nose)</p>

## R35TC-40 fittings

Page Dk-29	
<p><b>X5</b> <b>Dk-29</b></p>  <p>Flange – Straight Full flange system for Code 61 or Code 62</p>	<p><b>A0</b> <b>Dk-29</b></p>  <p>Super Steck0® fitting</p>





## V4 Interlock In-/Outside Skive

4 Wire Hoses

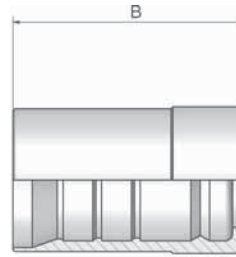

Only for use with adjustable crimpers.  
Minimum of 320 tons crimping force recommended.

XXXXX-XX-XX Part Number	Hose I.D.				B mm
	DN	Inch	Size	mm	
100V4-10	16	5/8	-10	15.9	49
100V4-12	20	3/4	-12	19.1	60
100V4-16	25	1	-16	25.4	75
100V4-20	32	1-1/4	-20	31.8	88
100V4-24	40	1-1/2	-24	38.1	94
100V4-32	50	2	-32	50.8	99

Also available in stainless steel. Details can be found in CAT 4400.1/UK

## V6 Interlock In-/Outside Skive

6 Wire Hoses



Only for use with adjustable crimpers.  
Minimum of 340 tons crimping force required.

XXXXX-XX-XX Part Number	Hose I.D.				B mm
	DN	Inch	Size	mm	
100V6-20	32	1-1/4	-20	31.8	90
100V6-24	40	1-1/2	-24	38.1	96
100V6-32	50	2	-32	50.8	110
100V6-40	65	2-1/2	-40	63.5	134

Also available in stainless steel. Details can be found in CAT 4400.1/UK

## VB Interlock In-/Outside Skive

6 Wire Hoses

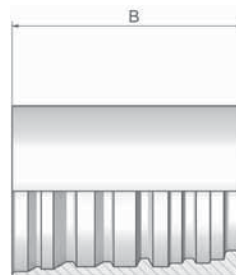

XXXXX-XX-XX Part Number	Hose I.D.				B mm
	DN	Inch	Size	mm	
100VB-16	25	1	-16	25.4	75

Only suitable for Hose R50TC-16-SP6  
See page Dk-27 and Dk-28

## CA Female Metric 24° Light Series with O-Ring Swivel – Straight

ISO 12151-2-SWS-L – DKOL

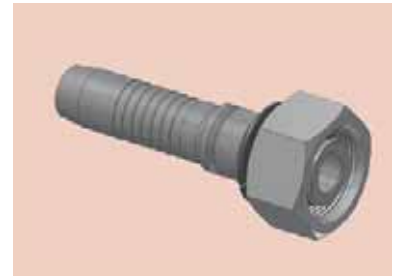
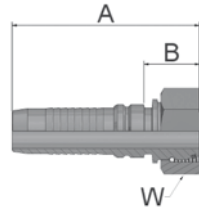

XXXXX-XX-XX Part Number V4/V6	Hose I.D.				Thread metric	Tube O.D. mm	A mm	B mm	W mm
	DN	Inch	Size	mm					
KCAV4-18-10	16	5/8	-10	15.9	M26x1.5	18	83	23	32
KCAV4-22-12	20	3/4	-12	19.1	M30x2	22	89	28	36
KCAV4-28-16	25	1	-16	25.4	M36x2	28	103	31	41
KCAV4-35-20	32	1-1/4	-20	31.8	M45x2	35	120	32	50
KCAV6-35-20	32	1-1/4	-20	31.8	M45x2	35	130	39	50
KCAV4-42-24	40	1-1/2	-24	38.1	M52x2	42	128	35	60
KCAV6-42-24	40	1-1/2	-24	38.1	M52x2	42	138	42	60

Fittings with standard O-ring seals can be used for temperatures from -30 °C up to +105 °C.  
Find O-rings in section E. Special O-rings are available on request.

## CE Female Metric 24° Light Series with O-Ring Swivel – 45° Elbow

ISO 12151-2-SWE 45°-L – DKOL 45°

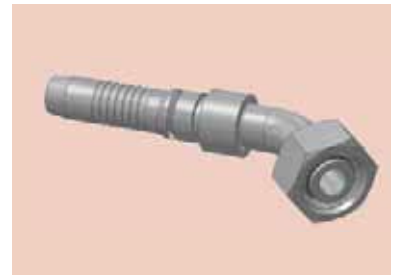
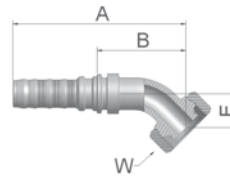

XXXXX-XX-XX Part Number V4/V6	Hose I.D.				Thread metric	Tube O.D. mm	A mm	B mm	E mm	W mm
	DN	Inch	Size	mm						
KCEV4-22-12	20	3/4	-12	19.1	M30x2	22	137	75	29	36
KCEV4-35-20	32	1-1/4	-20	31.8	M45x2	35	197	109	37	50
KCEV6-35-20	32	1-1/4	-20	31.8	M45x2	35	188	97	37	50
KCEV6-42-24	40	1-1/2	-24	38.1	M52x2	42	226	130	49	60

Fittings with standard O-ring seals can be used for temperatures from -30 °C up to +105 °C.  
Find O-rings in section E. Special O-rings are available on request.

Approved fitting series for hose types:

Also available in stainless steel. Details can be found in CAT 4400.1/UK

<b>V4</b>	-10 up to -16	H31	H31TC	H31ST	R42	R42TC	R42ST	-12 up to -20	R35	R35TC	H29	all sizes	H29TC	H29ST	H29RH
<b>V6</b>	-24 up to -32														
	R35	R35TC	-20 up to -32			R42	R42ST	R42TC							

**CF** **Female Metric 24°  
Light Series with O-Ring  
Swivel – 90° Elbow**

ISO 12151-2-SWE-L – DKOL 90°

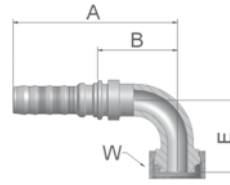

XXXXX-XX-XX Part Number V4/V6	Hose I.D.				Thread metric	Tube O.D. mm	A mm	B mm	E mm	W mm
	DN	Inch	Size	mm						
KCFV4-22-16	25	1	-16	25.4	M30x2	22	150	77	70	36
KCFV4-35-20	32	1-1/4	-20	31.8	M45x2	35	186	98	79	50
KCFV6-35-20	32	1-1/4	-20	31.8	M45x2	35	177	86	79	50
KCFV6-42-24	40	1-1/2	-24	38.1	M52x2	42	209	113	101	60

Fittings with standard O-ring seals can be used for temperatures from -30 °C up to +105 °C.  
Find O-rings in section E. Special O-rings are available on request.

Approved **fitting series** for hose types:

Also available in stainless steel. Details can be found in CAT 4400.1/UK

<b>V4</b>	-10 up to -16 H31 H31TC H31ST R42 R42TC R42ST   -12 up to -20 R35 R35TC H29   all sizes H29TC H29ST H29RH
<b>V6</b>	-24 up to -32 R35 R35TC   -20 up to -32 R42 R42ST R42TC

## C9 Female Metric 24° – Swivel Heavy Series with O-Ring Straight

ISO 12151-2-SWS-S – DKOS

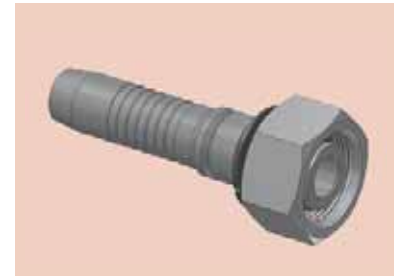
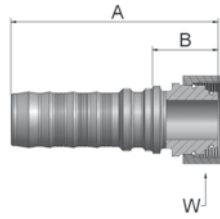

XXXXX-XX-XX Part Number V4/V6	Hose I.D.				Thread metric	Tube O.D. mm	A mm	B mm	W mm
	DN	Inch	Size	mm					
	KC9V4-20-10	16	5/8	-10					
KC9V4-20-12	20	3/4	-12	19.1	M30x2	20	88	26	36
KC9V4-25-12	20	3/4	-12	19.1	M36x2	25	91	30	46
KC9V4-30-12	20	3/4	-12	19.1	M42x2	30	95	33	50
KC9V4-25-16	25	1	-16	25.4	M36x2	25	103	30	46
KC9V4-30-16	25	1	-16	25.4	M42x2	30	108	35	50
KC9V4-38-16	25	1	-16	25.4	M52x2	38	110	37	60
KC9V4-30-20	32	1-1/4	-20	31.8	M42x2	30	123	35	50
KC9V6-30-20	32	1-1/4	-20	31.8	M42x2	30	131	41	50
KC9V4-38-20	32	1-1/4	-20	31.8	M52x2	38	126	38	60
KC9V6-38-20	32	1-1/4	-20	31.8	M52x2	38	135	44	60
KC9V4-38-24	40	1-1/2	-24	38.1	M52x2	38	129	36	60
KC9V6-38-24	40	1-1/2	-24	38.1	M52x2	38	139	43	60
KC9V6-54-32	50	2	-32	50.8	M68x2	54	175	60	80

## OC Female Metric 24° – Swivel Heavy Series with O-Ring 45° Elbow

ISO 12151-2 – SWE 45°-S – DKOS 45°

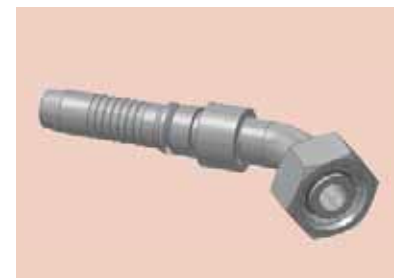
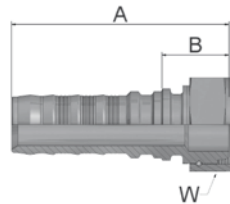

XXXXX-XX-XX Part Number V4/V6	Hose I.D.				Thread metric	Tube O.D. mm	A mm	B mm	E mm	W mm
	DN	Inch	Size	mm						
	KOCV4-20-10	16	5/8	-10						
KOCV4-20-12	20	3/4	-12	19.1	M30x2	20	138	76	30	36
KOCV4-25-12	20	3/4	-12	19.1	M36x2	25	127	64	29	46
KOCV4-25-16	25	1	-16	25.4	M36x2	25	160	87	33	46
KOCV4-30-16	25	1	-16	25.4	M42x2	30	162	89	33	50
KOCV4-30-20	32	1-1/4	-20	31.8	M42x2	30	193	105	34	50
KOCV6-30-20	32	1-1/4	-20	31.8	M42x2	30	184	93	34	50
KOCV4-38-20	32	1-1/4	-20	31.8	M52x2	38	197	109	37	60
KOCV6-38-20	32	1-1/4	-20	31.8	M52x2	38	187	96	37	60
KOCV4-38-24	40	1-1/2	-24	38.1	M52x2	38	228	134	49	60
KOCV6-38-24	40	1-1/2	-24	38.1	M52x2	38	226	130	49	60

Fittings with standard O-ring seals can be used for temperatures from -30 °C up to +105 °C.  
Find O-rings in section E. Special O-rings are available on request.

Approved fitting series for hose types:

Also available in stainless steel. Details can be found in CAT 4400.1/UK

<b>V4</b>	-10 up to -16 H31 H31TC H31ST R42 R42TC R42ST   -12 up to -20 R35 R35TC H29   all sizes H29TC H29ST H29RH
<b>V6</b>	-24 up to -32 R35 R35TC   -20 up to -32 R42 R42ST R42TC

# 1C Female Metric 24° – Swivel Heavy Series with O-Ring 90° Elbow

ISO 12151-2-SWE-S – DKOS 90°

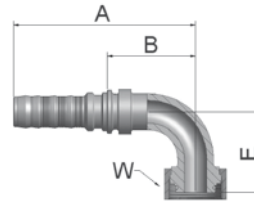

XXXXX-XX-XX Part Number V4/V6	Hose I.D.				Thread metric	Tube O.D. mm	A mm	B mm	E mm	W mm
	DN	Inch	Size	mm						
K1CV4-20-10	16	5/8	-10	15.9	M30x2	20	112	52	50	36
K1CV4-20-12	20	3/4	-12	19.1	M30x2	20	125	63	60	36
K1CV4-25-12	20	3/4	-12	19.1	M36x2	25	126	63	59	46
K1CV4-25-16	25	1	-16	25.4	M36x2	25	150	77	66	46
K1CV4-30-16	25	1	-16	25.4	M42x2	30	151	78	69	50
K1CV4-30-16-SL150	25	1	-16	25.4	M42x2	30	151	78	150	50
K1CV4-30-16-SL160	25	1	-16	25.4	M42x2	30	151	78	160	50
K1CV4-38-16	25	1	-16	25.4	M52x2	38	154	81	75	60
K1CV4-30-20	32	1-1/4	-20	31.8	M42x2	30	183	95	73	50
K1CV6-30-20	32	1-1/4	-20	31.8	M42x2	30	169	78	69	50
K1CV4-38-20	32	1-1/4	-20	31.8	M52x2	38	187	99	78	60
K1CV6-38-20	32	1-1/4	-20	31.8	M52x2	38	177	86	78	60
K1CV6-38-20-SL150	32	1-1/4	-20	31.8	M52x2	38	177	86	150	60
K1CV4-38-24	40	1-1/2	-24	38.1	M52x2	38	210	117	101	60
K1CV6-38-24	40	1-1/2	-24	38.1	M52x2	38	209	113	101	60

# D2 Male Metric 24° – Rigid Heavy Series – Straight

ISO 12151-2-S-S – CES

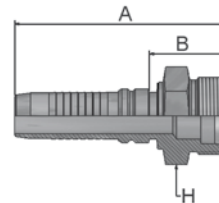

XXXXX-XX-XX Part Number V4/V6	Hose I.D.				Thread metric	Tube O.D. mm	A mm	B mm	H mm
	DN	Inch	Size	mm					
KD2V4-20-10	16	5/8	-10	15.9	M30x2	20	95	31	30
KD2V4-20-12	20	3/4	-12	19.1	M30x2	20	93	31	30
KD2V4-25-12	20	3/4	-12	19.1	M36x2	25	98	36	36
KD2V4-25-16	25	1	-16	25.4	M36x2	25	110	38	46
KD2V4-30-16	25	1	-16	25.4	M42x2	30	115	42	46
KD2V6-30-20	32	1-1/4	-20	31.8	M42x2	30	140	59	46
KD2V4-38-20	32	1-1/4	-20	31.8	M52x2	38	135	47	55
KD2V6-38-20	32	1-1/4	-20	31.8	M52x2	38	142	51	55
KD2V4-38-24	40	1-1/2	-24	38.1	M52x2	38	139	46	55
KD2V6-38-24	40	1-1/2	-24	38.1	M52x2	38	151	55	55

Approved fitting series for hose types:

Also available in stainless steel. Details can be found in CAT 4400.1/UK

<b>V4</b>	-10 up to -16 H31 H31TC H31ST R42 R42TC R42ST   -12 up to -20 R35 R35TC H29   all sizes H29TC H29ST H29RH
<b>V6</b>	-24 up to -32 R35 R35TC   -20 up to -32 R42 R42ST R42TC

## 92 Female BSP Parallel Pipe Swivel – Straight (60° Cone)

BS5200-A – DKR

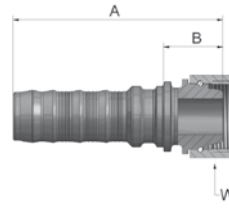

XXXXX-XX-XX Part Number V4/V6	Hose I.D.				Thread BSP	A mm	B mm	W mm
	DN	Inch	Size	mm				
K92V4-10-10	16	5/8	-10	15.9	5/8x14	80	20	30
K92V4-12-12	20	3/4	-12	19.1	3/4x14	85	23	32
K92V4-16-12	20	3/4	-12	19.1	1x11	93	31	41
K92V4-16-16	25	1	-16	25.4	1x11	105	32	41
K92V4-20-20	32	1-1/4	-20	31.8	1-1/4x11	118	30	50
K92V6-20-20	32	1-1/4	-20	31.8	1-1/4x11	127	36	50
K92V4-24-24	40	1-1/2	-24	38.1	1-1/2x11	124	31	55
K92V6-24-24	40	1-1/2	-24	38.1	1-1/2x11	134	38	55
K92V4-32-32	50	2	-32	50.8	2x11	131	34	70
K92V6-32-32	50	2	-32	50.8	2x11	151	41	70

## B1 Female BSP Parallel Pipe Swivel 45° Elbow (60° Cone)

BS 5200-D – DKR 45°

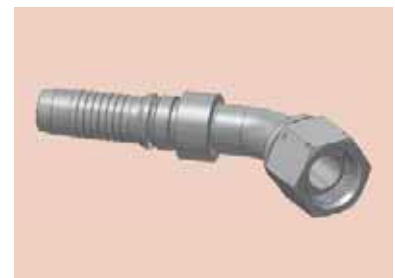
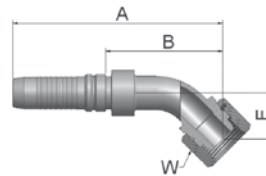

XXXXX-XX-XX Part Number V4/V6	Hose I.D.				Thread BSP	A mm	B mm	E mm	W mm
	DN	Inch	Size	mm					
KB1V4-12-12	20	3/4	-12	19.1	3/4x14	134	72	26	32
KB1V4-16-16	25	1	-16	25.4	1x11	164	91	36	41
KB1V4-20-20	32	1-1/4	-20	31.8	1-1/4x11	198	110	38	50
KB1V6-20-20	32	1-1/4	-20	31.8	1-1/4x11	194	103	43	50
KB1V4-24-24	40	1-1/2	-24	38.1	1-1/2x11	230	137	52	55
KB1V6-24-24	40	1-1/2	-24	38.1	1-1/2x11	229	133	52	55
KB1V4-32-32	50	2	-32	50.8	2x11	277	180	70	70
KB1V6-32-32	50	2	-32	50.8	2x11	288	178	70	70

Approved fitting series for hose types:

Also available in stainless steel. Details can be found in CAT 4400.1/UK

<b>V4</b>	-10 up to -16 H31 H31TC H31ST R42 R42TC R42ST   -12 up to -20 R35 R35TC H29   all sizes H29TC H29ST H29RH
<b>V6</b>	-24 up to -32 R35 R35TC   -20 up to -32 R42 R42ST R42TC

## B2 Female BSP Parallel Pipe Swivel 90° Elbow (60° Cone)

BS 5200-B – DKR 90°

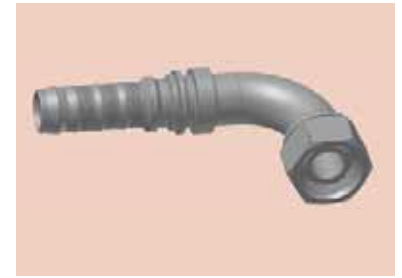
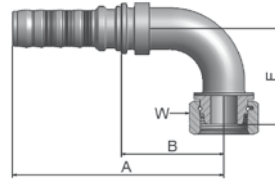

XXXXX-XX-XX Part Number V4/V6	Hose I.D.				Thread BSP	A mm	B mm	E mm	W mm
	DN	Inch	Size	mm					
KB2V4-12-12	20	3/4	-12	19.1	3/4x14	125	63	55	32
KB2V4-16-16	25	1	-16	25.4	1x11	150	77	74	41
KB2V4-20-20	32	1-1/4	-20	31.8	1-1/4x11	186	99	80	50
KB2V6-20-20	32	1-1/4	-20	31.8	1-1/4x11	177	86	80	50
KB2V4-24-24	40	1-1/2	-24	38.1	1-1/2x11	210	117	103	55
KB2V6-24-24	40	1-1/2	-24	38.1	1-1/2x11	209	113	103	55
KB2V4-32-32	50	2	-32	50.8	2x11	257	160	149	70
KB2V6-32-32	50	2	-32	50.8	2x11	268	157	149	70

## D9 Male BSP Parallel Pipe Rigid – Straight (60° Cone)

BS5200 – AGR

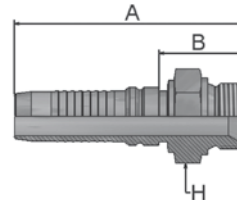

XXXXX-XX-XX Part Number V4/V6	Hose I.D.				Thread BSP	A mm	B mm	H mm
	DN	Inch	Size	mm				
KD9V4-10-10	16	5/8	-10	15.9	5/8x14	94	35	30
KD9V4-12-12	20	3/4	-12	19.1	3/4x14	99	37	32
KD9V4-16-16	25	1	-16	25.4	1x11	115	43	41
KD9V4-20-20	32	1-1/4	-20	31.8	1-1/4x11	134	46	50
KD9V6-20-20	32	1-1/4	-20	31.8	1-1/4x11	139	48	50
KD9V4-24-24	40	1-1/2	-24	38.1	1-1/2x11	142	48	55
KD9V6-24-24	40	1-1/2	-24	38.1	1-1/2x11	148	52	55
KD9V4-32-32	50	2	-32	50.8	2x11	148	50	70
KD9V6-32-32	50	2	-32	50.8	2x11	168	58	70

Approved fitting series for hose types:

Also available in stainless steel. Details can be found in CAT 4400.1/UK

V4	-10 up to -16 H31 H31TC H31ST R42 R42TC R42ST   -12 up to -20 R35 R35TC H29   all sizes H29TC H29ST H29RH
V6	-24 up to -32 R35 R35TC   -20 up to -32 R42 R42ST R42TC

# 91 Male BSP Taper Pipe – Rigid Straight

BS5200 – AGR-K

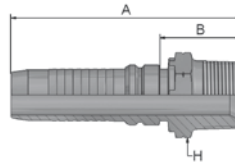

XXXXX-XX-XX Part Number V4/V6	Hose I.D.				Thread BSP	A mm	B mm	H mm
	DN	Inch	Size	mm				
K91V4-12-12	20	3/4	-12	19.1	3/4x14	99	37	30
K91V4-16-16	25	1	-16	25.4	1x11	113	40	36
K91V4-20-20	32	1-1/4	-20	31.8	1-1/4x11	131	43	46
K91V4-24-24	40	1-1/2	-24	38.1	1-1/2x11	152	59	55
K91V4-32-32	50	2	-32	50.8	2x11	166	68	65

Approved **fitting series** for hose types:

Also available in stainless steel. Details can be found in CAT 4400.1/UK

<b>V4</b>	-10 up to -16	H31	H31TC	H31ST	R42	R42TC	R42ST	-12 up to -20	R35	R35TC	H29	all sizes	H29TC	H29ST	H29RH
<b>V6</b>	-24 up to -32														
	R35	R35TC	-20 up to -32		R42	R42ST	R42TC								



# 01

## Male NPTF Pipe Rigid – Straight

SAE J476A / J516 – AGN

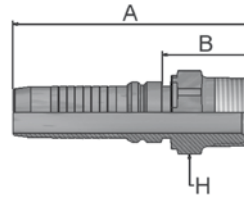

XXXXX-XX-XX Part Number V4/V6	Hose I.D.				Thread NPTF	A mm	B mm	H mm
	DN	Inch	Size	mm				
K01V4-12-12	20	3/4	-12	19.1	3/4x14	100	38	30
K01V4-16-16	25	1	-16	25.4	1x11-1/2	117	44	36
K01V4-20-20	32	1-1/4	-20	31.8	1-1/4x11-1/2	146	58	46
K01V6-20-20	32	1-1/4	-20	31.8	1-1/4x11-1/2	151	60	46
K01V4-24-24	40	1-1/2	-24	38.1	1-1/2x11-1/2	148	55	50
K01V6-24-24	40	1-1/2	-24	38.1	1-1/2x11-1/2	159	63	50
K01V4-32-32	50	2	-32	50.8	2x11-1/2	160	62	65
K01V6-32-32	50	2	-32	50.8	2x11-1/2	181	70	65

# 03

## Male JIC 37° – Rigid Straight

ISO12151-5-S – AGJ

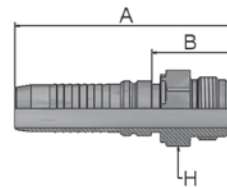

XXXXX-XX-XX Part Number V4/V6	Hose I.D.				Thread UNF	A mm	B mm	H mm
	DN	Inch	Size	mm				
K03V4-12-12	20	3/4	-12	19.1	1-1/16x12	101	39	30
K03V4-16-12	20	3/4	-12	19.1	1-5/16x12	103	41	36
K03V4-16-16	25	1	-16	25.4	1-5/16x12	117	44	36
K03V4-20-16	25	1	-16	25.4	1-5/8x12	122	50	46
K03V4-20-20	32	1-1/4	-20	31.8	1-5/8x12	139	51	46
K03V6-20-20	32	1-1/4	-20	31.8	1-5/8x12	147	56	46
K03V4-24-20	32	1-1/4	-20	31.8	1-7/8x12	139	51	50
K03V4-24-24	40	1-1/2	-24	38.1	1-7/8x12	146	53	50
K03V6-24-24	40	1-1/2	-24	38.1	1-7/8x12	156	60	50
K03V4-32-32	50	2	-32	50.8	2-1/2x12	161	64	65
K03V6-32-32	50	2	-32	50.8	2-1/2x12	182	72	65

Approved fitting series for hose types:

Also available in stainless steel. Details can be found in CAT 4400.1/UK

<b>V4</b>	-10 up to -16 H31 H31TC H31ST R42 R42TC R42ST   -12 up to -20 R35 R35TC H29   all sizes H29TC H29ST H29RH
<b>V6</b>	-24 up to -32 R35 R35TC   -20 up to -32 R42 R42ST R42TC

## 06 Female JIC 37° – Swivel Straight

ISO12151-5-SWS – DKJ

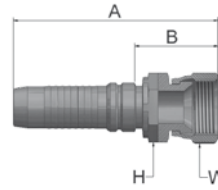

XXXXX-XX-XX Part Number V4/V6	Hose I.D.				Thread UNF	A mm	B mm	H mm	W mm
	DN	Inch	Size	mm					
K06V4-12-12	20	3/4	-12	19.1	1-1/16x12	105	43	30	32
K06V4-16-12	20	3/4	-12	19.1	1-5/16x12	109	48	36	41
K06V4-12-16	25	1	-16	25.4	1-1/16x12	121	49	36	32
K06V4-16-16	25	1	-16	25.4	1-5/16x12	122	50	36	41
K06V4-20-16	25	1	-16	25.4	1-5/8x12	125	52	41	50
K06V4-20-20	32	1-1/4	-20	31.8	1-5/8x12	146	58	46	50
K06V6-20-20	32	1-1/4	-20	31.8	1-5/8x12	154	63	46	50
K06V4-24-20	32	1-1/4	-20	31.8	1-7/8x12	150	63	50	60
K06V6-24-20	32	1-1/4	-20	31.8	1-7/8x12	159	68	50	60
K06V4-24-24	40	1-1/2	-24	38.1	1-7/8x12	152	59	50	60
K06V6-24-24	40	1-1/2	-24	38.1	1-7/8x12	163	67	50	60
K06V4-32-32	50	2	-32	50.8	2-1/2x12	168	77	65	75
K06V6-32-32	50	2	-32	50.8	2-1/2x12	188	78	65	75

## 37 Female JIC 37° – Swivel 45° Elbow

ISO 12151-5-SWE 45° – DKJ 45°

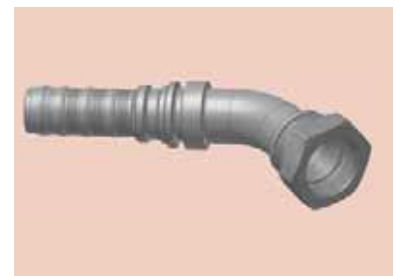
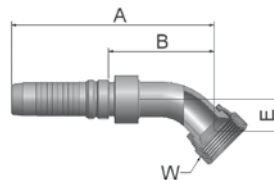

XXXXX-XX-XX Part Number V4/V6	Hose I.D.				Thread UNF	A mm	B mm	E mm	W mm
	DN	Inch	Size	mm					
K37V4-12-12	20	3/4	-12	19.1	1-1/16x12	128	67	21	32
K37V4-16-16	25	1	-16	25.4	1-5/16x12	152	80	24	41
K37V4-20-20	32	1-1/4	-20	31.8	1-5/8x12	201	113	42	50
K37V6-20-20	32	1-1/4	-20	31.8	1-5/8x12	192	101	42	50
K37V4-24-24	40	1-1/2	-24	38.1	1-7/8x12	227	134	49	60
K37V6-24-24	40	1-1/2	-24	38.1	1-7/8x12	235	139	58	60
K37V4-32-32	50	2	-32	50.8	2-1/2x12	279	182	72	75
K37V6-32-32	50	2	-32	50.8	2-1/2x12	290	180	72	75

Approved fitting series for hose types:

Also available in stainless steel. Details can be found in CAT 4400.1/UK

V4	-10 up to -16	H31	H31TC	H31ST	R42	R42TC	R42ST	-12 up to -20	R35	R35TC	H29	all sizes	H29TC	H29ST	H29RH
V6	-24 up to -32														
	R35 R35TC   -20 up to -32														
	R42 R42ST R42TC														

# 39 Female JIC 37° – Swivel 90° Elbow

ISO 12151-5-SWES – DKJ 90°

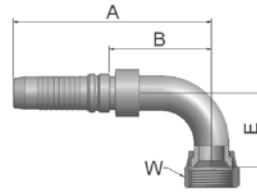

XXXXX-XX-XX Part Number V4/V6	Hose I.D.				Thread UNF	A mm	B mm	E mm	W mm
	DN	Inch	Size	mm					
K39V4-12-12	20	3/4	-12	19.1	1-1/16x12	125	63	48	32
K39V4-16-12	20	3/4	-12	19.1	1-5/16x12	125	63	56	41
K39V4-16-16	25	1	-16	25.4	1-5/16x12	150	78	56	41
K39V4-20-16	25	1	-16	25.4	1-5/8x12	150	77	62	50
K39V4-20-20	32	1-1/4	-20	31.8	1-5/8x12	186	98	85	50
K39V6-20-20	32	1-1/4	-20	31.8	1-5/8x12	177	86	85	50
K39V4-24-20	32	1-1/4	-20	31.8	1-7/8x12	186	98	80	60
K39V4-24-24	40	1-1/2	-24	38.1	1-7/8x12	210	117	102	60
K39V6-24-24	40	1-1/2	-24	38.1	1-7/8x12	209	113	102	60
K39V4-32-32	50	2	-32	50.8	2-1/2x12	257	160	152	75
K39V6-32-32	50	2	-32	50.8	2-1/2x12	268	157	152	75

Approved fitting series for hose types:

Also available in stainless steel. Details can be found in CAT 4400.1/UK

<b>V4</b>	-10 up to -16 H31 H31TC H31ST R42 R42TC R42ST   -12 up to -20 R35 R35TC H29   all sizes H29TC H29ST H29RH
<b>V6</b>	-24 up to -32 R35 R35TC   -20 up to -32 R42 R42ST R42TC

# 15/4A SAE Code 61 Flange Straight

ISO 12151-3-S-L – SFL  
5000 psi

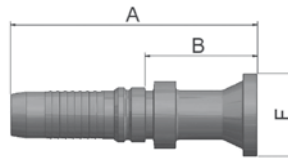

XXXXX-XX-XX Part Number V4/V6	Hose I.D.				Flange	A mm	B mm	F mm
	DN	Inch	Size	mm				
K15V4-12-12	20	3/4	-12	19.1	3/4	119	58	38
K15V4-16-12	20	3/4	-12	19.1	1	100	38	45
K15V4-12-16	25	1	-16	25.4	3/4	135	62	38
K15V4-16-16	25	1	-16	25.4	1	133	61	45
K4AV4-20-16	25	1	-16	25.4	1-1/4	101	28	51
K15V4-16-20	32	1-1/4	-20	31.8	1	152	64	45
K15V6-16-20	32	1-1/4	-20	31.8	1	161	70	44
K4AV4-20-20	32	1-1/4	-20	31.8	1-1/4	160	72	51
K4AV6-20-20	32	1-1/4	-20	31.8	1-1/4	167	76	51
K4AV4-24-20	32	1-1/4	-20	31.8	1-1/2	126	39	60
K4AV6-24-20	32	1-1/4	-20	31.8	1-1/2	165	74	60
K4AV4-20-24	40	1-1/2	-24	38.1	1-1/4	167	73	51
K4AV4-24-24	40	1-1/2	-24	38.1	1-1/2	190	97	60
K4AV6-24-24	40	1-1/2	-24	38.1	1-1/2	201	105	60
K4AV4-32-24	40	1-1/2	-24	38.1	2	149	56	71
K4AV6-32-24	40	1-1/2	-24	38.1	2	159	63	71
K4AV4-32-32	50	2	-32	50.8	2	189	92	71
K4AV6-32-32	50	2	-32	50.8	2	210	100	71

Find SAE flange halves in section Eb.

Approved **fitting series** for hose types:

Also available in stainless steel. Details can be found in CAT 4400.1/UK

<b>V4</b>	-10 up to -16 H31 H31TC H31ST R42 R42TC R42ST   -12 up to -20 R35 R35TC H29   all sizes H29TC H29ST H29RH
<b>V6</b>	-24 up to -32 R35 R35TC   -20 up to -32 R42 R42ST R42TC

# 17/4F SAE Code 61 Flange 45° Elbow

ISO 12151-3 – E45S – L – SFL 45°  
5000 psi

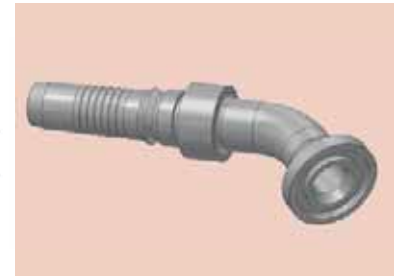
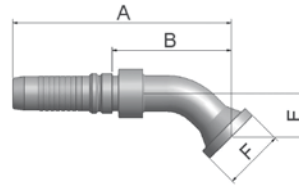

XXXXX-XX-XX Part Number V4/V6	Hose I.D.				Flange	A mm	B mm	E mm	F mm
	DN	Inch	Size	mm					
K17V4-12-12	20	3/4	-12	19.1	3/4	133	71	26	38
K17V4-16-12	20	3/4	-12	19.1	1	133	71	26	45
K17V4-16-16	25	1	-16	25.4	1	160	88	32	45
K17V4-16-20	32	1-1/4	-20	31.8	1	198	110	38	45
K17V6-16-20	32	1-1/4	-20	31.8	1	188	97	38	44
K4FV4-20-12	20	3/4	-12	19.1	1-1/4	133	71	25	51
K4FV4-20-16	25	1	-16	25.4	1-1/4	160	88	32	51
K4FV4-20-20	32	1-1/4	-20	31.8	1-1/4	198	110	38	51
K4FV6-20-20	32	1-1/4	-20	31.8	1-1/4	188	97	38	51
K4FV4-24-20	32	1-1/4	-20	31.8	1-1/2	198	110	38	60
K4FV6-24-20	32	1-1/4	-20	31.8	1-1/2	188	97	38	60
K4FV4-20-24	40	1-1/2	-24	38.1	1-1/4	214	121	44	51
K4FV6-20-24	40	1-1/2	-24	38.1	1-1/4	201	105	44	51
K4FV4-24-24	40	1-1/2	-24	38.1	1-1/2	222	129	44	60
K4FV6-24-24	40	1-1/2	-24	38.1	1-1/2	221	125	44	60
K4FV4-32-24	40	1-1/2	-24	38.1	2	222	129	44	71
K4FV6-32-24	40	1-1/2	-24	38.1	2	221	125	44	71
K4FV4-32-32	50	2	-32	50.8	2	269	171	62	71
K4FV6-32-32	50	2	-32	50.8	2	274	164	56	71

Find SAE flange halves in section Eb.

Approved fitting series for hose types:

Also available in stainless steel. Details can be found in CAT 4400.1/UK

<b>V4</b>	-10 up to -16 H31 H31TC H31ST R42 R42TC R42ST   -12 up to -20 R35 R35TC H29   all sizes H29TC H29ST H29RH
<b>V6</b>	-24 up to -32 R35 R35TC   -20 up to -32 R42 R42ST R42TC

# 19/4N SAE Code 61 Flange 90° Elbow

ISO 12151-3-E-L – SFL 90°  
5000 psi

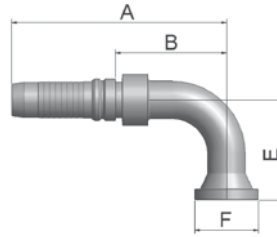

XXXXX-XX-XX Part Number V4/V6	Hose I.D.				Flange	A mm	B mm	E mm	F mm
	DN	Inch	Size	mm					
K19V4-12-12	20	3/4	-12	19.1	3/4	125	63	58	38
K19V4-12-12-SL100	20	3/4	-12	19.1	3/4	125	63	100	38
K19V4-16-12	20	3/4	-12	19.1	1	125	63	58	45
K19V4-16-16	25	1	-16	25.4	1	150	78	70	45
K19V4-16-16-SL130	25	1	-16	25.4	1	150	78	130	45
K19V4-16-16-SL210	25	1	-16	25.4	1	150	78	210	45
K19V4-16-20	32	1-1/4	-20	31.8	1	186	99	90	45
K19V6-16-20	32	1-1/4	-20	31.8	1	177	86	90	44
K4NV4-20-12-SL65	20	3/4	-12	19.1	3/4	125	63	65	51
K4NV4-20-16	25	1	-16	25.4	1-1/4	150	78	68	51
K4NV4-20-16-SL130	25	1	-16	25.4	1-1/4	150	78	130	51
K4NV4-20-20	32	1-1/4	-20	31.8	1-1/4	186	99	90	51
K4NV4-20-20-SL120	32	1-1/4	-20	31.8	1-1/4	186	99	120	51
K4NV4-20-20-SL150	32	1-1/4	-20	31.8	1-1/4	186	99	150	51
K4NV4-20-20-SL165	32	1-1/4	-20	31.8	1-1/4	186	99	165	51
K4NV6-20-20	32	1-1/4	-20	31.8	1-1/4	177	86	90	51
K4NV4-24-20	32	1-1/4	-20	31.8	1-1/2	186	99	90	60
K4NV4-24-20-SL110	32	1-1/4	-20	31.8	1-1/2	186	99	110	60
K4NV4-24-20-SL150	32	1-1/4	-20	31.8	1-1/2	186	99	150	60
K4NV6-24-20	32	1-1/4	-20	31.8	1-1/2	177	86	90	60
K4NV6-24-20-SL200	32	1-1/4	-20	31.8	1-1/2	177	86	200	60
K4NV4-20-24	40	1-1/2	-24	38.1	1-1/4	197	104	104	51
K4NV6-20-24	40	1-1/2	-24	38.1	1-1/4	184	88	104	51
K4NV4-24-24	40	1-1/2	-24	38.1	1-1/2	210	117	104	60
K4NV4-24-24-SL150	40	1-1/2	-24	38.1	1-1/2	210	117	150	60
K4NV4-24-24-SL200	40	1-1/2	-24	38.1	1-1/2	210	117	200	60
K4NV4-24-24-SL250	40	1-1/2	-24	38.1	1-1/2	210	117	250	60
K4NV6-24-24	40	1-1/2	-24	38.1	1-1/2	209	113	104	60
K4NV6-24-24-SL200	40	1-1/2	-24	38.1	1-1/2	209	113	200	60
K4NV4-32-24	40	1-1/2	-24	38.1	2	210	117	104	71
K4NV6-32-24	40	1-1/2	-24	38.1	2	209	113	104	71
K4NV4-24-32	50	2	-32	50.8	1-1/2	227	130	138	60
K4NV4-24-32-SL160	50	2	-32	50.8	1-1/2	227	130	160	60
K4NV4-32-32	50	2	-32	50.8	2	257	160	138	71
K4NV6-32-32	50	2	-32	50.8	2	268	157	138	71

Find SAE flange halves in section Eb.

Approved fitting series for hose types:

Also available in stainless steel. Details can be found in CAT 4400.1/UK

<b>V4</b>	-10 up to -16 H31 H31TC H31ST R42 R42TC R42ST   -12 up to -20 R35 R35TC H29   all sizes H29TC H29ST H29RH
<b>V6</b>	-24 up to -32 R35 R35TC   -20 up to -32 R42 R42ST R42TC

# 6A

## SAE Code 62 Flange Straight

ISO 12151-3-S-S – SFS  
6000 psi

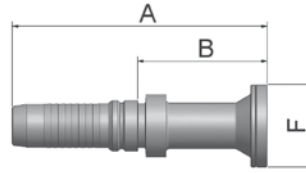

XXXXX-XX-XX Part Number V4/V6	Hose I.D.				Flange	A mm	B mm	F mm
	DN	Inch	Size	mm				
K6AV4-8-10	16	5/8	-10	15.9	1/2	121	62	32
K6AV4-12-10	16	5/8	-10	15.9	3/4	94	34	41
K6AV4-12-12	20	3/4	-12	19.1	3/4	126	64	41
K6AV4-16-12	20	3/4	-12	19.1	1	100	38	48
K6AV4-12-16	25	1	-16	25.4	3/4	150	77	41
K6AV4-16-16	25	1	-16	25.4	1	148	75	48
K6AV4-20-16	25	1	-16	25.4	1-1/4	116	44	54
K6AV4-24-16	25	1	-16	25.4	1-1/2	118	45	64
K6AV4-16-20	32	1-1/4	-20	31.8	1	166	8	48
K6AV6-16-20	32	1-1/4	-20	31.8	1	175	84	48
K6AV4-20-20	32	1-1/4	-20	31.8	1-1/4	166	84	54
K6AV6-20-20	32	1-1/4	-20	31.8	1-1/4	175	83	54
K6AV4-24-20	32	1-1/4	-20	31.8	1-1/2	139	51	64
K6AV6-24-20	32	1-1/4	-20	31.8	1-1/2	147	56	64
K6AV4-20-24	40	1-1/2	-24	38.1	1-1/4	174	95	54
K6AV6-20-24	40	1-1/2	-24	38.1	1-1/4	185	89	54
K6AV4-24-24	40	1-1/2	-24	38.1	1-1/2	192	103	64
K6AV6-24-24	40	1-1/2	-24	38.1	1-1/2	201	106	64
K6AV4-32-24	40	1-1/2	-24	38.1	2	184	91	79
K6AV6-32-24	40	1-1/2	-24	38.1	2	194	98	79
K6AV4-24-32	50	2	-32	50.8	1-1/2	198	101	64
K6AV6-24-32	50	2	-32	50.8	1-1/2	219	108	64
K6AV4-32-32	50	2	-32	50.8	2	212	115	79
K6AV6-32-32	50	2	-32	50.8	2	233	122	79

Find SAE flange halves in section Eb.

Approved fitting series for hose types:

Also available in stainless steel. Details can be found in CAT 4400.1/UK

<b>V4</b>	-10 up to -16 H31 H31TC H31ST R42 R42TC R42ST   -12 up to -20 R35 R35TC H29   all sizes H29TC H29ST H29RH
<b>V6</b>	-24 up to -32 R35 R35TC   -20 up to -32 R42 R42ST R42TC

# 6F

## SAE Code 62 Flange 45° Elbow – Heavy Series

ISO 12151-3 – E45-S – SFS 45°  
6000 psi

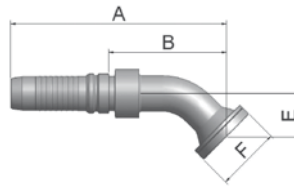

XXXXX-XX-XX Part Number V4/V6	Hose I.D.				Flange	A mm	B mm	E mm	F mm
	DN	Inch	Size	mm					
K6FV4-8-10	16	5/8	-10	15.9	1/2	123	63	26	32
K6FV4-12-10	16	5/8	-10	15.9	3/4	123	63	26	41
K6FV4-12-12	20	3/4	-12	19.1	3/4	133	72	26	41
K6FV4-12-12-SL55	20	3/4	-12	19.1	3/4	162	101	55	41
K6FV4-16-12	20	3/4	-12	19.1	1	133	71	26	48
K6FV4-16-12-SL55	20	3/4	-12	19.1	1	162	101	55	48
K6FV4-12-16	25	1	-16	25.4	3/4	154	82	32	41
K6FV4-16-16	25	1	-16	25.4	1	160	88	32	48
K6FV4-20-16	25	1	-16	25.4	1-1/4	161	89	32	54
K6FV4-16-20	32	1-1/4	-20	31.8	1	198	110	38	48
K6FV6-16-20	32	1-1/4	-20	31.8	1	188	97	38	48
K6FV4-20-20	32	1-1/4	-20	31.8	1-1/4	198	110	38	54
K6FV4-20-20-SL60	32	1-1/4	-20	31.8	1-1/4	220	132	60	54
K6FV6-20-20	32	1-1/4	-20	31.8	1-1/4	189	97	38	54
K6FV6-20-20-SL60	32	1-1/4	-20	31.8	1-1/4	210	119	60	54
K6FV4-24-20	32	1-1/4	-20	31.8	1-1/2	198	110	38	64
K6FV4-24-20-SL60	32	1-1/4	-20	31.8	1-1/2	220	132	60	64
K6FV6-24-20	32	1-1/4	-20	31.8	1-1/2	189	97	38	64
K6FV4-20-24	40	1-1/2	-24	38.1	1-1/2	214	121	44	54
K6FV6-20-24	40	1-1/2	-24	38.1	1-1/4	209	113	44	54
K6FV4-24-24	40	1-1/2	-24	38.1	1-1/2	222	129	44	64
K6FV4-24-24-SL200	40	1-1/2	-24	38.1	1-1/2	222	129	200	64
K6FV4-24-24-SL60	40	1-1/2	-24	38.1	1-1/2	222	129	60	64
K6FV4-24-24-SL70	40	1-1/2	-24	38.1	1-1/2	248	155	70	64
K6FV6-24-24	40	1-1/2	-24	38.1	1-1/2	221	125	44	64
K6FV6-24-24-SL70	40	1-1/2	-24	38.1	1-1/2	221	125	70	64
K6FV4-32-24	40	1-1/2	-24	38.1	2	222	129	44	79
K6FV6-32-24	40	1-1/2	-24	38.1	2	221	125	44	79
K6FV4-24-32	50	2	-32	50.8	1-1/2	245	147	56	64
K6FV6-24-32	50	2	-32	50.8	1-1/2	260	149	56	64
K6FV4-32-32	50	2	-32	50.8	2	263	166	56	79
K6FV4-32-32-SL70	50	2	-32	50.8	2	277	180	70	79
K6FV6-32-32	50	2	-32	50.8	2	274	163	56	79

Find SAE flange halves in section Eb.

Approved fitting series for hose types:

Also available in stainless steel. Details can be found in CAT 4400.1/UK

<b>V4</b>	-10 up to -16 H31 H31TC H31ST R42 R42TC R42ST   -12 up to -20 R35 R35TC H29   all sizes H29TC H29ST H29RH
<b>V6</b>	-24 up to -32 R35 R35TC   -20 up to -32 R42 R42ST R42TC



# 6N

## SAE Code 62 Flange 90° Elbow

ISO 12151-3 – E-S – SFS 90°  
6000 psi

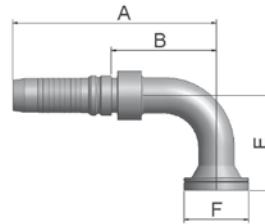

XXXXX-XX-XX Part Number V4/V6	Hose I.D.				Flange	A mm	B mm	E mm	F mm
	DN	Inch	Size	mm					
K6NV4-8-10	16	5/8	-10	15.9	1/2	111	51	54	32
K6NV4-12-10	16	5/8	-10	15.9	3/4	111	50	54	41
K6NV4-12-12	20	3/4	-12	19.1	3/4	125	63	58	41
K6NV4-12-12-SL100	20	3/4	-12	19.1	3/4	125	63	100	41
K6NV4-12-12-SL70	20	3/4	-12	19.1	3/4	125	63	70	41
K6NV4-12-12-SL80	20	3/4	-12	19.1	3/4	125	63	80	41
K6NV4-12-12-SL86	20	3/4	-12	19.1	3/4	125	63	86	41
K6NV4-16-12	20	3/4	-12	19.1	1	125	63	58	48
K6NV4-16-12-SL100	20	3/4	-12	19.1	1	125	63	100	48
K6NV4-16-12-SL90	20	3/4	-12	19.1	1	125	63	90	48
K6NV4-12-16	25	1	-16	25.4	3/4	140	68	70	41
K6NV4-12-16-SL55	25	1	-16	25.4	3/4	140	68	55	41
K6NV4-12-16-SL80	25	1	-16	25.4	3/4	140	68	80	41
K6NV4-16-16	25	1	-16	25.4	1	150	78	70	48
K6NV4-16-16-SL110	25	1	-16	25.4	1	150	78	110	48
K6NV4-16-16-SL125	25	1	-16	25.4	1	150	78	125	48
K6NV4-16-16-SL140	25	1	-16	25.4	1	150	78	140	48
K6NV4-16-16-SL80	25	1	-16	25.4	1	150	78	80	48
K6NV4-20-16	25	1	-16	25.4	1-1/4	154	82	70	54
K6NV4-20-16-SL150	25	1	-16	25.4	1-1/4	154	82	150	54
K6NV4-20-16-SL175	25	1	-16	25.4	1-1/4	154	82	175	54
K6NV4-20-16-SL65	25	1	-16	25.4	1-1/4	154	82	65	54

Size -20 up to size -32:  
please see next page!

Approved fitting series for hose types:

Also available in stainless steel. Details can be found in CAT 4400.1/UK

V4	-10 up to -16 H31 H31TC H31ST R42 R42TC R42ST   -12 up to -20 R35 R35TC H29   all sizes H29TC H29ST H29RH
V6	-24 up to -32 R35 R35TC   -20 up to -32 R42 R42ST R42TC

# 6N

## SAE Code 62 Flange 90° Elbow

ISO 12151-3 – E-S – SFS 90°  
6000 psi

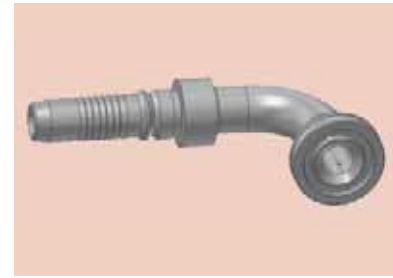
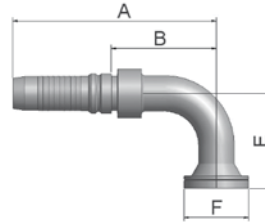

XXXXX-XX-XX Part Number V4/V6	Hose I.D.				Flange	A mm	B mm	E mm	F mm
	DN	Inch	Size	mm					
	K6NV4-16-20	32	1-1/4	-20					
K6NV6-16-20	32	1-1/4	-20	31.8	1	177	86	90	48
K6NV4-20-20	32	1-1/4	-20	31.8	1-1/4	186	99	90	54
K6NV4-20-20-SL120	32	1-1/4	-20	31.8	1-1/4	186	98	120	54
K6NV4-20-20-SL140	32	1-1/4	-20	31.8	1-1/4	186	98	140	54
K6NV4-20-20-SL155	32	1-1/4	-20	31.8	1-1/4	186	98	155	54
K6NV4-20-20-SL200	32	1-1/4	-20	31.8	1-1/4	186	98	200	54
K6NV6-20-20	32	1-1/4	-20	31.8	1-1/4	177	86	90	54
K6NV6-20-20-SL120	32	1-1/4	-20	31.8	1-1/4	177	86	120	54
K6NV6-20-20-SL150	32	1-1/4	-20	31.8	1-1/4	177	86	150	54
K6NV4-24-20	32	1-1/4	-20	31.8	1-1/2	186	99	90	64
K6NV4-24-20-SL135	32	1-1/4	-20	31.8	1-1/2	186	98	135	64
K6NV6-24-20	32	1-1/4	-20	31.8	1-1/2	177	86	90	64
K6NV4-20-24	40	1-1/2	-24	38.1	1-1/4	197	104	104	54
K6NV6-20-24	40	1-1/2	-24	38.1	1-1/4	192	96	104	54
K6NV4-24-24	40	1-1/2	-24	38.1	1-1/2	210	117	104	64
K6NV4-24-24-SL140	40	1-1/2	-24	38.1	1-1/2	210	117	140	64
K6NV4-24-24-SL150	40	1-1/2	-24	38.1	1-1/2	210	117	150	64
K6NV4-24-24-SL160	40	1-1/2	-24	38.1	1-1/2	210	117	160	64
K6NV4-24-24-SL200	40	1-1/2	-24	38.1	1-1/2	210	117	200	64
K6NV4-24-24-SL250	40	1-1/2	-24	38.1	1-1/2	210	117	250	64
K6NV6-24-24	40	1-1/2	-24	38.1	1-1/2	210	113	104	64
K6NV6-24-24-SL190	40	1-1/2	-24	38.1	1-1/2	210	113	190	64
K6NV4-32-24	40	1-1/2	-24	38.1	2	210	117	104	79
K6NV6-32-24	40	1-1/2	-24	38.1	2	209	113	104	79
K6NV4-24-32	50	2	-32	50.8	1-1/2	221	124	104	64
K6NV6-24-32	50	2	-32	50.8	1-1/2	236	125	104	64
K6NV4-32-32	50	2	-32	50.8	2	257	160	138	79
K6NV6-32-32	50	2	-32	50.8	2	268	157	138	79
K6NV6-32-32-SL145	50	2	-32	50.8	2	268	157	145	79

Size -10 up to size -16:  
please see previous page!

Approved fitting series for hose types:

Also available in stainless steel. Details can be found in CAT 4400.1/UK

V4	-10 up to -16 H31 H31TC H31ST R42 R42TC R42ST   -12 up to -20 R35 R35TC H29   all sizes H29TC H29ST H29RH
V6	-24 up to -32 R35 R35TC   -20 up to -32 R42 R42ST R42TC

## X5 Flange – Straight

Full flange system for  
Code 61 or Code 62

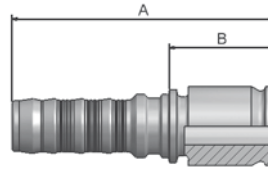

XXXXX-XX-XX Part Number V4/V6	Hose I.D.				Flange	A mm	B mm
	DN	Inch	Size	mm			
KX5V6-20-20	32	1-1/4	-20	31.8	1-1/4	152	61
KX5V6-24-24	40	1-1/2	-24	38.1	1-1/2	159	63
KX5V6-32-32	50	2	-32	50.8	2	186	75
KX5V6-40-40	65	2-1/2	-40	63.5	2-1/2	233	98

Find SAE flange halves in section Eb.

## X7 Flange – 45° Elbow

Full flange system for  
Code 61 or Code 62

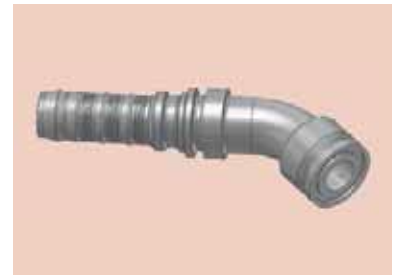
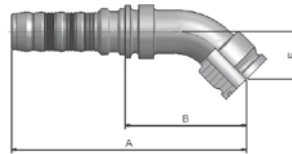

XXXXX-XX-XX Part Number V4/V6	Hose I.D.				Flange	A mm	B mm	E mm
	DN	Inch	Size	mm				
KX7V6-20-20	32	1-1/4	-20	31.8	1-1/4	188	97	38
KX7V6-24-24	40	1-1/2	-24	38.1	1-1/2	221	125	44
KX7V6-32-32	50	2	-32	50.8	2	275	165	57

Find SAE flange halves in section Eb.

Approved **fitting series** for hose types:

Also available in stainless steel. Details can be found in CAT 4400.1/UK

<b>V4</b>	-10 up to -16 H31 H31TC H31ST R42 R42TC R42ST   -12 up to -20 R35 R35TC H29   all sizes H29TC H29ST H29RH
<b>V6</b>	-24 up to -32 R35 R35TC   -40 R35TC   -20 up to -32 R42 R42ST R42TC

## X9 Flange – 90° Elbow

Full flange system for  
Code 61 or Code 62

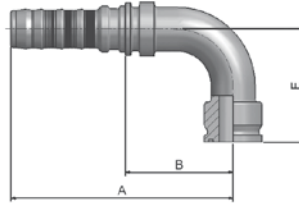

XXXXX-XX-XX Part Number V4/V6	Hose I.D.				Flange	A mm	B mm	E mm
	DN	Inch	Size	mm				
KX9V6-20-20	32	1-1/4	-20	31.8	1-1/4	177	86	90
KX9V6-24-24	40	1-1/2	-24	38.1	1-1/2	209	113	104
KX9V6-32-32	50	2	-32	50.8	2	268	157	138

Find SAE flange halves in section Eb.

## PY Flange – 24° Male French Gas Straight

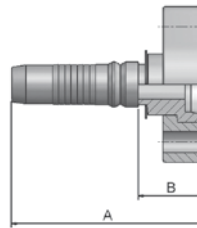

XXXXX-XX-XX Part Number V4/V6	Hose I.D.				Flange	A mm	B mm
	DN	Inch	Size	mm			
KPYV4-12-12	20	3/4	-12	19.1	3/4	92	30
KPYV4-16-16	25	1	-16	25.4	1	112	39

Approved **fitting series** for hose types:

Also available in stainless steel. Details can be found in CAT 4400.1/UK

<b>V4</b>	-10 up to -16 H31 H31TC H31ST R42 R42TC R42ST   -12 up to -20 R35 R35TC H29   all sizes H29TC H29ST H29RH
<b>V6</b>	-24 up to -32 R35 R35TC   -20 up to -32 R42 R42ST R42TC

## XA Caterpillar® Flange Straight

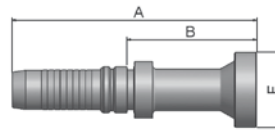

XXXXX-XX-XX Part Number V4/V6	Hose I.D.				Flange	A mm	B mm	F mm
	DN	Inch	Size	mm				
KXAV4-12-12	20	3/4	-12	19.1	3/4	132	71	41
KXAV4-16-12	20	3/4	-12	19.1	1	144	82	48
KXAV4-16-16	25	1	-16	25.4	1	155	82	48
KXAV4-20-16	25	1	-16	25.4	1-1/4	160	88	54
KXAV6-20-20	32	1-1/4	-20	31.8	1-1/4	181	90	54
KXAV6-24-20	32	1-1/4	-20	31.8	1-1/2	188	97	64
KXAV6-24-24	40	1-1/2	-24	38.1	1-1/2	207	111	64

## XF Caterpillar® Flange 45° Elbow

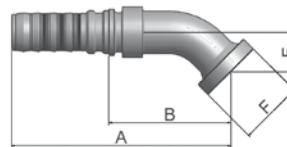

XXXXX-XX-XX Part Number V4/V6	Hose I.D.				Flange	A mm	B mm	E mm	F mm
	DN	Inch	Size	mm					
KXFV4-12-12	20	3/4	-12	19.1	3/4	138	76	31	41
KXFV4-16-16	25	1	-16	25.4	1	164	91	36	48
KXFV4-20-16	25	1	-16	25.4	1-1/4	164	92	35	54
KXFV6-20-20	32	1-1/4	-20	31.8	1-1/4	187	96	37	54
KXFV6-24-20	32	1-1/4	-20	31.8	1-1/2	187	96	36	64
KXFV6-24-24	40	1-1/2	-24	38.1	1-1/2	216	120	39	64

Approved **fitting series** for hose types:

Also available in stainless steel. Details can be found in CAT 4400.1/UK

<b>V4</b>	-10 up to -16 H31 H31TC H31ST R42 R42TC R42ST   -12 up to -20 R35 R35TC H29   all sizes H29TC H29ST H29RH
<b>V6</b>	-24 up to -32 R35 R35TC   -20 up to -32 R42 R42ST R42TC

**XG** Caterpillar® Flange  
60° Elbow

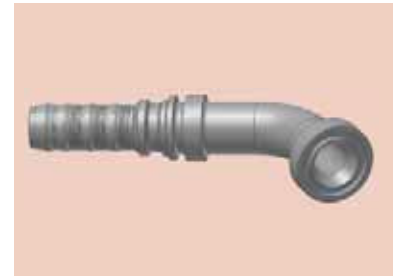
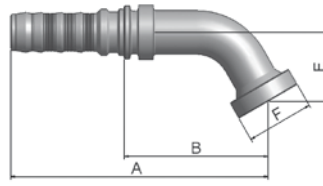

XXXXX-XX-XX Part Number V4/V6	Hose I.D.				Flange	A mm	B mm	E mm	F mm
	DN	Inch	Size	mm					
KXGV4-16-12	20	3/4	-12	19.1	1	152	91	42	48
KXGV4-16-16	25	1	-16	25.4	1	182	109	50	48
KXGV4-20-16	25	1	-16	25.4	1-1/4	184	112	50	54
KXGV6-20-20	32	1-1/4	-20	31.8	1-1/4	206	115	55	54
KXGV6-24-20	32	1-1/4	-20	31.8	1-1/2	208	117	52	64
KXGV6-24-24	40	1-1/2	-24	38.1	1-1/2	266	170	52	64

**XN** Caterpillar® Flange  
90° Elbow

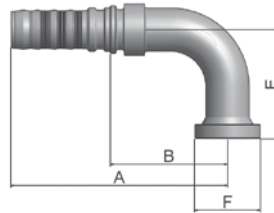

XXXXX-XX-XX Part Number V4/V6	Hose I.D.				Flange	A mm	B mm	E mm	F mm
	DN	Inch	Size	mm					
KXNV4-12-12	20	3/4	-12	19.1	3/4	125	63	63	41
KXNV4-16-12	20	3/4	-12	19.1	1	125	63	62	48
KXNV4-16-16	25	1	-16	25.4	1	150	77	74	48
KXNV4-20-16	25	1	-16	25.4	1-1/4	154	81	74	54
KXNV6-20-20	32	1-1/4	-20	31.8	1-1/4	177	86	77	54
KXNV6-24-20	32	1-1/4	-20	31.8	1-1/2	177	86	77	64
KXNV6-24-24	40	1-1/2	-24	38.1	1-1/2	209	113	106	64

Approved fitting series for hose types:

Also available in stainless steel. Details can be found in CAT 4400.1/UK

<b>V4</b>	-10 up to -16 H31 H31TC H31ST R42 R42TC R42ST   -12 up to -20 R35 R35TC H29   all sizes H29TC H29ST H29RH
<b>V6</b>	-24 up to -32 R35 R35TC   -20 up to -32 R42 R42ST R42TC

JC

**Female ORFS  
Swivel – Straight  
Short**

ISO 12151-1 – SWSA  
SAE J516 – ORFS

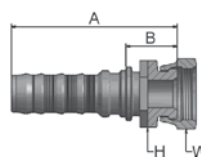

XXXXX-XX-XX Part Number V4/V6	Hose I.D.				Thread UNF	A mm	B mm	H mm	W mm
	DN	Inch	Size	mm					
KJCV4-10-10	16	5/8	-10	15.9	1x14	85	25	24	30
KJCV4-12-10	16	5/8	-10	15.9	1-3/16x12	87	27	30	36
KJCV4-10-12	20	3/4	-12	19.1	1x14	91	30	30	30
KJCV4-12-12	20	3/4	-12	19.1	1-3/16x12	93	31	30	36
KJCV4-16-12	20	3/4	-12	19.1	1-7/16x12	93	31	36	41
KJCV4-12-16	25	1	-16	25.4	1-3/16x12	101	29	36	36
KJCV4-16-16	25	1	-16	25.4	1-7/16x12	108	36	36	41
KJCV4-20-16	25	1	-16	25.4	1-11/16x12	120	47	41	50
KJCV4-20-20	32	1-1/4	-20	31.8	1-11/16x12	127	39	46	50
KJCV6-20-20	32	1-1/4	-20	31.8	1-11/16x12	132	41	46	50
KJCV6-24-20	32	1-1/4	-20	31.8	2x12	133	42	50	60
KJCV4-24-24	40	1-1/2	-24	38.1	2x12	131	38	50	60
KJCV6-24-24	40	1-1/2	-24	38.1	2x12	140	44	50	60

Approved **fitting series** for hose types:

Also available in stainless steel. Details can be found in CAT 4400.1/UK

<b>V4</b>	-10 up to -16 H31 H31TC H31ST R42 R42TC R42ST   -12 up to -20 R35 R35TC H29   all sizes H29TC H29ST H29RH
<b>V6</b>	-24 up to -32 R35 R35TC   -20 up to -32 R42 R42ST R42TC

## JS ORFS Swivel Female (Long)

ISO 12151-1-SWSB  
SAE J516 – ORFS

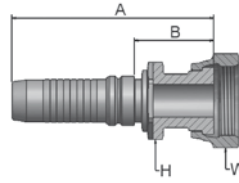

XXXXX-XX-XX Part Number V4/V6	Hose I.D.				Thread UNF	A mm	B mm	H mm	W mm
	DN	Inch	Size	mm					
KJSV4-16-16	25	1	-16	25.4	1-7/16x12	121	49	36	41
KJSV4-20-16	25	1	-16	25.4	1-11/16x12	120	48	41	50
KJSV4-20-20	32	1-1/4	-20	31.8	1-11/16x12	137	50	41	50

## J7 Female ORFS – Swivel 45° Elbow

ISO 12151-1 – SWE 45°  
SAE J516 – ORFS 45°

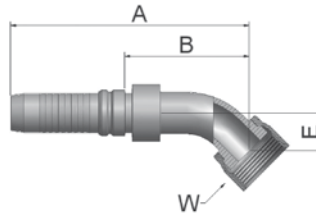

XXXXX-XX-XX Part Number V4/V6	Hose I.D.				Thread UNF	A mm	B mm	E mm	W mm
	DN	Inch	Size	mm					
KJ7V4-12-10	16	5/8	-10	15.9	1-3/16x12	118	58	21	36
KJ7V4-12-12	20	3/4	-12	19.1	1-3/16x12	128	66	21	36
KJ7V4-16-12	20	3/4	-12	19.1	1-7/16x12	131	70	24	41
KJ7V4-16-16	25	1	-16	25.4	1-7/16x12	152	80	24	41
KJ7V4-20-16	25	1	-16	25.4	1-11/16x12	154	81	26	50
KJ7V4-20-20	32	1-1/4	-20	31.8	1-11/16x12	189	102	30	50
KJ7V6-20-20	32	1-1/4	-20	31.8	1-11/16x12	179	88	33	50
KJ7V6-24-20	32	1-1/4	-20	31.8	2x12	190	99	40	60
KJ7V4-24-24	40	1-1/2	-24	38.1	2x12	218	125	40	60
KJ7V6-24-24	40	1-1/2	-24	38.1	2x12	216	120	40	60

Approved **fitting series** for hose types:

Also available in stainless steel. Details can be found in CAT 4400.1/UK

<b>V4</b>	-10 up to -16	H31	H31TC	H31ST	R42	R42TC	R42ST	-12 up to -20	R35	R35TC	H29	all sizes	H29TC	H29ST	H29RH	
<b>V6</b>	-24 up to -32															
	R35	R35TC	-20 up to -32			R42	R42ST	R42TC								



# J9 Female ORFS – Swivel 90° Elbow – Short Drop

ISO 12151-1 – SWES  
SAE J516 – ORFS 90°

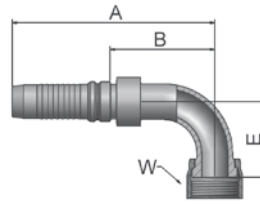

XXXXX-XX-XX Part Number V4/V6	Hose I.D.				Thread UNF	A mm	B mm	E mm	W mm
	DN	Inch	Size	mm					
KJ9V4-10-10	16	5/8	-10	15.9	1x14	107	47	32	30
KJ9V4-12-10	16	5/8	-10	15.9	1-3/16x12	108	48	48	36
KJ9V4-12-12	20	3/4	-12	19.1	1-3/16x12	125	63	48	36
KJ9V4-16-12	20	3/4	-12	19.1	1-7/16x12	125	63	56	41
KJ9V4-16-16	25	1	-16	25.4	1-7/16x12	150	78	56	41
KJ9V4-20-16	25	1	-16	25.4	1-11/16x12	150	77	64	50
KJ9V4-20-20	32	1-1/4	-20	31.8	1-11/16x12	186	99	69	50
KJ9V6-20-20	32	1-1/4	-20	31.8	1-11/16x12	177	86	79	50
KJ9V6-24-20	32	1-1/4	-20	31.8	2x12	177	86	70	60
KJ9V4-24-24	40	1-1/2	-24	38.1	2x12	210	117	82	60
KJ9V6-24-24	40	1-1/2	-24	38.1	2x12	202	106	87	60

# JM ORFS Male

ISO 12151-1-S – SAE J516

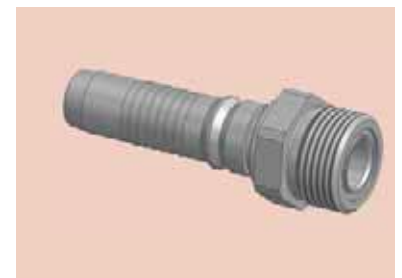
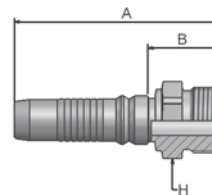

XXXXX-XX-XX Part Number V4/V6	Hose I.D.				Thread UNF	A mm	B mm	H mm
	DN	Inch	Size	mm				
KJMV4-12-12	20	3/4	-12	19.1	1x14	95	33	32
KJMV4-16-12	20	3/4	-12	19.1	1-7/16x12	98	37	41

JM fittings are supplied without O-ring.  
Find O-rings in section E. Special O-rings are available on request.

Approved fitting series for hose types:

Also available in stainless steel. Details can be found in CAT 4400.1/UK

V4	-10 up to -16 H31 H31TC H31ST R42 R42TC R42ST   -12 up to -20 R35 R35TC H29   all sizes H29TC H29ST H29RH
V6	-24 up to -32 R35 R35TC   -20 up to -32 R42 R42ST R42TC

## FG Male French Gas Series Rigid – Straight (24° Cone)

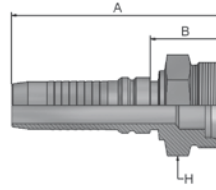

XXXXX-XX-XX Part Number V4/V6	Hose I.D.				Thread metric	Tube O.D. mm	A mm	B mm	H mm
	DN	Inch	Size	mm					
KFGV4-27-12	20	3/4	-12	19.1	M36x1.5	26.75	94	32	36
KFGV4-33-16	25	1	-16	25.4	M45x1.5	33.50	111	39	46

## F4 Female French Gas Series Swivel – Straight (Ball Nose)

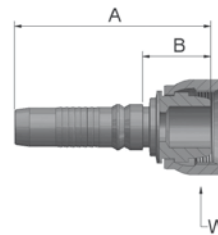

XXXXX-XX-XX Part Number V4/V6	Hose I.D.				Thread metric	Tube O.D. mm	A mm	B mm	W mm
	DN	Inch	Size	mm					
KF4V4-27-12	20	3/4	-12	19.1	M36x1.5	26.75	90	31	46

Approved **fitting series** for hose types:

Also available in stainless steel. Details can be found in CAT 4400.1/UK

<b>V4</b>	-10 up to -16	H31	H31TC	H31ST	R42	R42TC	R42ST	-12 up to -20	R35	R35TC	H29	all sizes	H29TC	H29ST	H29RH
<b>V6</b>	-24 up to -32														
	R35 R35TC   -20 up to -32														
	R42 R42ST R42TC														

## 8A Flange – Straight

8000 psi

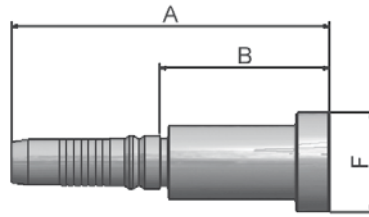

XXXXX-XX-XX Part Number V4	Hose I.D.				Flange	A mm	B mm	F mm
	DN	Inch	Size	mm				
K8AV4-12-10	16	5/8	-10	15.9	3/4	130	71	41
K8AV4-12-12	20	3/4	-12	19.1	3/4	132	71	41
K8AV4-16-12	20	3/4	-12	19.1	1	143	82	48
K8AV4-16-16	25	1	-16	25.4	1	148	75	48
K8AVB-16-16	25	1	-16	25.4	1	148	71	48
K8AV4-20-16	25	1	-16	25.4	1-1/4	111	39	54
K8AVB-20-16	25	1	-16	25.4	1-1/4	111	39	54
K8AV6-20-20	32	1-1/4	-20	31.8	1-1/4	111	39	54

## 8F Flange – 45° Elbow

8000 psi

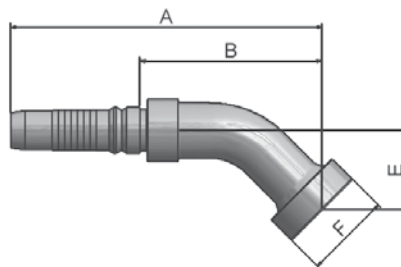

XXXXX-XX-XX Part Number V4	Hose I.D.				Flange	A mm	B mm	E mm	F mm
	DN	Inch	Size	mm					
K8FV4-12-10	16	5/8	-10	15.9	3/4	123	64	26	41
K8FV4-12-12	20	3/4	-12	19.1	3/4	138	76	26	41
K8FV4-16-12	20	3/4	-12	19.1	1	143	81	32	48
K8FV4-16-16	25	1	-16	25.4	1	178	105	35	48
K8FVB-16-16	25	1	-16	25.4	1	178	105	35	48
K8FV4-20-16	25	1	-16	25.4	1-1/4	178	105	35	54
K8FVB-20-16	25	1	-16	25.4	1-1/4	178	105	35	54
K8FV6-20-20	32	1-1/4	-20	31.8	1-1/4	194	103	38	54

Approved **fitting series** for hose types:

<b>V4</b>	R50TC-10   R50TC-12   R50TC-16-SP4
<b>VB</b>	R50TC-16-SP6
<b>V6</b>	R50TC-20

# 8N Flange – 90° Elbow

8000 psi

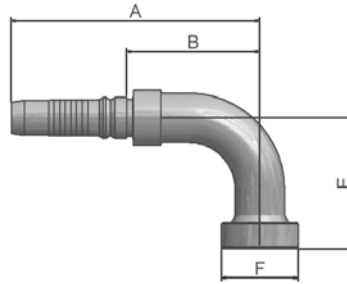

XXXXX-XX-XX Part Number V4	Hose I.D.				Flange	A mm	B mm	E mm	F mm
	DN	Inch	Size	mm					
	K8NV4-12-10	16	5/8	-10	15.9	3/4	111	51	58
K8NV4-12-12	20	3/4	-12	19.1	3/4	133	71	70	41
K8NV4-16-12	20	3/4	-12	19.1	1	133	71	70	48
K8NV4-16-16	25	1	-16	25.4	1	170	97	75	48
K8NVB-16-16	25	1	-16	25.4	1	170	97	75	48
K8NV4-20-16	25	1	-16	25.4	1-1/4	170	97	90	54
K8NVB-20-16	25	1	-16	25.4	1-1/4	170	97	90	54
K8NV6-20-20	32	1-1/4	-20	31.8	1-1/4	182	91	90	54

Approved **fitting series** for hose types:

<b>V4</b>	R50TC-10   R50TC-12   R50TC-16-SP4
<b>VB</b>	R50TC-16-SP6
<b>V6</b>	R50TC-20

## V6 Interlock In-/Outside Skive

6 Wire Hoses



Only for use with adjustable crimpers.  
Minimum of 340 tons crimping force required.

XXXXX-XX-XX Part Number	Hose I.D.				B mm
	DN	Inch	Size	mm	
100V6-40	65	2-1/2	-40	63.5	134

## X5 Flange - Straight

Full flange system for Code 61 or Code 62

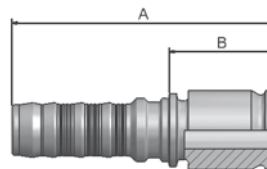

XXXXX-XX-XX Part Number V6	Hose I.D.				Flange	A mm	B mm
	DN	Inch	Size	mm			
KX5V6-40-40	65	2-1/2	-40	63.5	2-1/2	233	98

## A0 Super Steck0® fitting

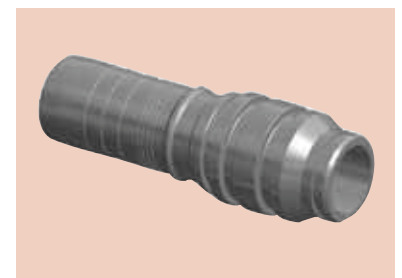
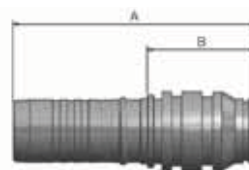

XXXXX-XX-XX Part Number V6	Hose I.D.				A mm	B mm
	DN	Inch	Size	mm		
KA0V6-40-40	65	2-1/2	-40	63.5	245	110

Approved **fitting series** for hose types:







aerospace  
climate control  
electromechanical  
filtration  
fluid & gas handling  
hydraulics  
pneumatics  
process control  
sealing & shielding



# Hydraulic Hoses, Fittings and Equipment

Machines, Tooling, Accessories



ENGINEERING YOUR SUCCESS.

# Hydraulic Hose Assembly Workshop Equipment

– meeting the demands of professional hose assembly manufacture

Hose assemblies must be manufactured in conformity with all the relevant EN/ISO standards and with the requirements of various work safety and trade associations.

Hose Products Division Europe has selected and developed a complete range of machines and tooling to ensure effective and safe production of hose assemblies. This can be achieved only when equipment designed for the purpose is used.

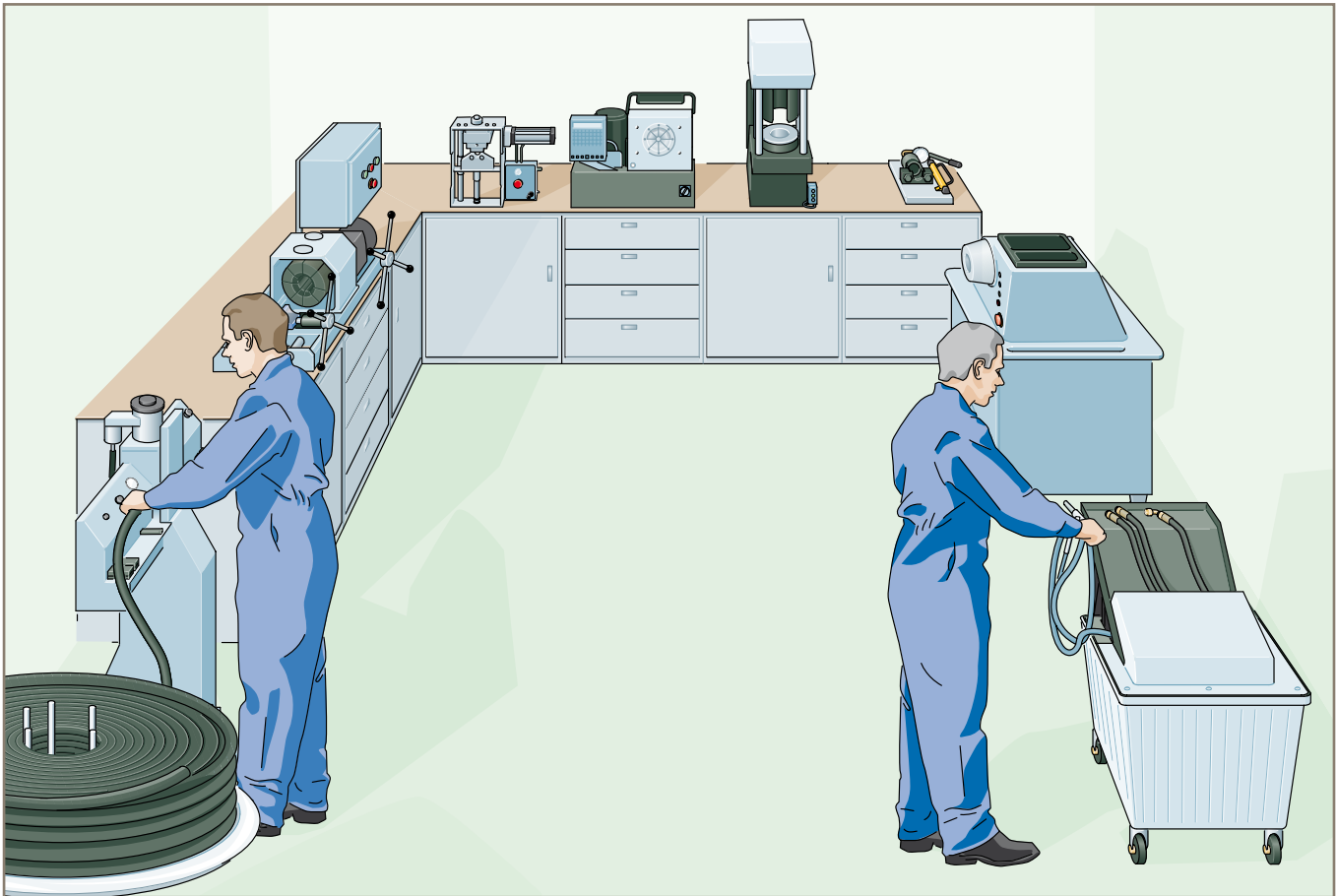

The programme includes the right tools for cutting hoses and for the crimping, marking and cleaning of hose assemblies; also, last but not least, appropriate hose assembly testing equipment, all of which allow production of ready-to-install Parkrimp No-Skive and ParLock hose assemblies.



# Hydraulic Hose Assembly Workshop Equipment



Hose Cut-Off Machine  
TH 3-14



Hose Cut-Off Machine TH 3-2

The Parker range of Parkrimp machines and crimping machine technology are recognised industry-wide as the easiest and most accurate crimping system available.



Hose Assembly  
Test Bench TH5-3



Hose Reel TH7-12



Cleaning System  
TH6-6

# Parkrimp® *No-Skive*

The system for fast and leak-free assemblies

Hose fittings have an impact on the overall efficiency and safety of a hydraulic system.

The No-Skive concept was launched by Parker Hannifin some 30 years ago but

continuous development and the use of modern materials and production techniques have resulted in a state-of-the-art hose to fitting connection. Much easier handling and a high level of safety

are available with No-Skive crimp fittings. Parker offers No-Skive fittings in one and two pieces as part of a package consisting of quality hose, No-Skive fittings, hose crimpers and tooling.

## Parkrimp *No-Skive* one-piece fittings

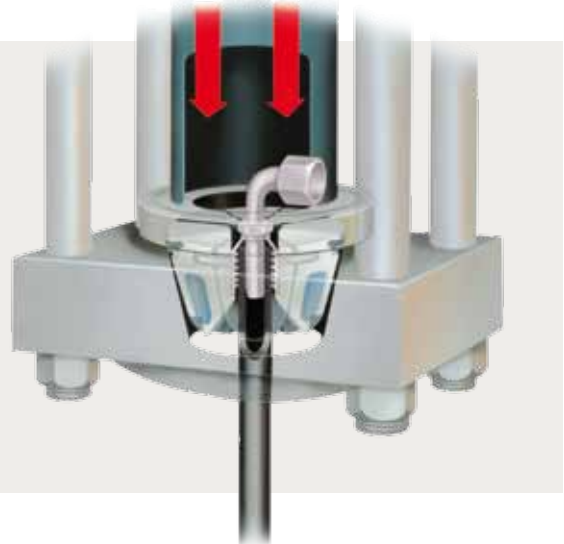

### Parkrimp® No-Skive

- No skiving tool needed
- No need to remove the cover
- Crimps one-piece fittings
- Parkalign positions the fittings in the die perfectly every time
- Quick and easy: no gauges to set on the machine
- Portable machines for field repair
- Meets EN safety regulations

## Modular Design with all the familiar Parkrimp System

Parker's Hose Products Division Europe introduces two new Parkrimp-style modular crimpers – KarryKrimp 1 and the KarryKrimp 2. The new modular design enables the customer to

choose between the portability that Parker KarryKrimp crimpers have always offered, and the new option to make these same crimpers bench mounted units. The modular design gives users

the flexibility of a portable crimper with the advantage of increased productivity when connected to the stationary power unit.

### Modular Parkrimp crimpers for *No-Skive* one-piece fittings



KarryKrimp® 1

KarryKrimp® 1  
(bench mounted unit)

KarryKrimp® 2

KarryKrimp® 2  
(bench mounted unit)

# ParLock Hose and Fittings

The high-performance skiving system

Certain customers and applications stipulate the usage of multi-spiral hose assemblies with external/internal skive-type fittings. With the ParLock hose and fitting range, Parker meets this demanding market requirement.

Parker adjustable crimpers for two-piece fittings ensure precise, leak-free and tear-proof assembly of hose and fitting.

- High flex-impulse applications
- High vibration applications

- The ParLock design is approved by the German Accident Prevention & Insurance Association (Berufsgenossenschaft) conforming to EN 201 (approved for injection-moulding machine applications)

## ParLock two-piece skive fittings



Hose skiving machine TH2-13-3PH

## The ParLock System

- A full range of multi-spiral hoses to ISO 3862 (4SP to R15)
- Field-tested, proven reliability
- Hose and fitting combinations giving performance that exceeds ISO/EN requirements
- Approved hose and fitting compatibility "one manufacturer, one source"

## Adjustable crimpers for two-piece ParLock skive fittings



TH8E-530

TH8E-380-BM

TH8-800-BM

# Hose Whip Restraint

## Safety Restraining System for Pressure Hoses



- Prevents whipping of a pressurized hose in the event of the hose separating from its fitting
- The system consists of two parts – a hose collar and a cable assembly



Parker's Hose Whip Restraint System is designed to prevent whipping of a pressurized hose in the event of the hose separating from its fitting. The Hose Whip Restraint System provides an additional level of safety and helps prevent damage to nearby equipment or injury to operators near the failed hose by limiting the whip or travel of the pressurized hose after it breaks free from its hose fitting. Serious damage or injury can occur from whipping hoses, especially at higher pressures.

The system consists of two parts – a hose collar and a cable assembly. The hose collar (WRCxx) is selected based on the outside diameter of the hose, and the cable assembly is selected based on the type of hose connection. Two types of cable assemblies are available – one for flange-type connections (WRFxxx), and the other for port adapters (WRAxxx).

The Hose Whip Restraint is not to be used in place of proper hose crimping procedures. Exceeding the maximum operating pressure of the hose jeopardizes the proper operation of the Hose Whip Restraint System.

### Hose collars

for Hose Whip Restraint System

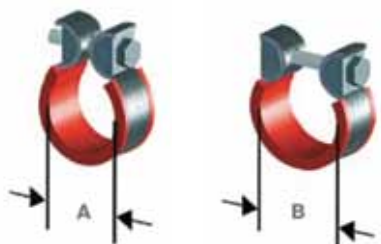

### Cable Assemblies

for hoses attached with port adapters



### Cable Assemblies

for hoses using flange-style connections (code 61 and code 62 flanges)



For more information about hose whip restraint please refer to page Eb-18

# Machines, Tooling, Accessories

## Machines

Parkrimp® Crimping Presses	Ea-1 – Ea-4
Accessories for Parkrimp® Crimping Presses	Ea-5
Parkrimp® Die Sets	Ea-6
Hose Cutting Machines	Ea-7 – Ea-13
Marking Machines	Ea-14 – Ea-15
Cleaning Systems	Ea-16 – Ea-19
Hose Assembly Test Bench	Ea-20
Hose Reels	Ea-21 – Ea-22
Adjustable Crimping Presses	Ea-23 – Ea-25
Hose Skiving Machines	Ea-26 – Ea-28
Skiving tools for Hose Skiving Machines	Ea-29

## Accessories

Flange Half	Eb-1
Full Flange System	Eb-2
Banjo Bolt	Eb-3
O-Rings	Eb-4 – Eb-5
Worm Drive Hose Clamps	Eb-6 – Eb-7
Hose Protection	Eb-8 – Eb-17
Hose Whip Restraint	Eb-18
Containment Grips	Eb-19
Thread Identification Kit	Eb-19
Parker „Hoze-Oil“	Eb-20
OilOn	Eb-20
Push-Lok® Assembly Oil	Eb-20
Push-Lok® Assembly Tool	Eb-20

## Assembly Instructions

KarryKrimp® 1 (Parkrimp® 1) / KarryKrimp® 2 (PHastkrimp®)	Ec-1
Parkrimp® 2	Ec-2

## Crimp Charts

KarryKrimp® 1 (Parkrimp® 1)	Ed-1 – Ed-3
KarryKrimp® 2 (PHastkrimp®)	Ed-4 – Ed-7
Parkrimp® 2	Ed-8 – Ed-11
Adjustable Crimper	Ed-12 – Ed-13



## KarryKrimp® 1

Modular portable crimper  
for braided hoses

- Crimps
  - 1 and 2 steel wire or textile braided hoses size -4 up to size -20
- Available in modular design with all Parkrimp system advantages
- The same unit offers portability and bench mountability
- Easily portable for outside work
- Used for service with hand pump or airhydraulic and electrical pump
- Portable, compact rugged design
- Pivoting pusher design for easy die change out
- Increased height enables longer bent tube fittings to be crimped

### Primary Applications

Small workshops, repair shops, mobile service vehicles

### Fittings Series

**26, 46, 48**



### Restrictions

Not suitable for multispiral hoses, 2-piece fittings, stainless steel fittings and serial production of hose assemblies in size -12 and above.

### Technical / Order Data

<b>KarryKrimp 1</b>	Dimensions	H 760 x W335 x D 330 mm
	Weight	28 kg
	<b>Part Number</b>	<b>82CE-061L</b>

### Included standard equipment

<i>Crimp head</i>		<b>Part Number</b>	<b>82CE-CHD</b>
<i>Stand assembly</i>		<b>Part Number</b>	<b>85C-STD</b>
<i>Hose assembly</i>		<b>Part Number</b>	<b>85CE-00L</b>
<i>Die rings</i>	silver	<b>Part Number</b>	<b>82C-R01</b>
	black	<b>Part Number</b>	<b>82C-R02</b>

Accessories see page **Ea-5**

## KarryKrimp® 2

Modular portable crimper  
for braided and multispiral hoses

- Crimps
  - 1 and 2 steel wire or textile braided hoses up to size -20
  - 3 steel wire braided hoses up to size -16
  - 4 layer multispiral hoses up to size -16
  - compact spiral hoses up to size -12
- Available in modular design with all Parkrimp system advantages
- The same unit offers portability and bench mountability
- Easily portable for outside work
- Used for service with hand pump, airhydraulic or electrical pump
- Portable, compact rugged design
- Pivoting pusher design for easy die change out



### Primary Applications

Small workshops, repair shops, mobile service vehicles.  
Crimps both steel and stainless steel fittings.

### Restrictions

Not suitable for 2-piece fittings.

### Fittings Series

**26, 46, 48, 70, 71, 73, 77, 78**

### Technical / Order Data

KarryKrimp 2	Dimensions	H 805 x W 340 x D 350 mm
	Weight	46 kg
	Part Number	85CE-061L

### Included standard equipment

<i>Crimp head</i>	Part Number	85CE-CHD
<i>Stand assembly</i>	Part Number	85C-STD
<i>Hose assembly</i>	Part Number	85CE-00L
<i>Die rings</i>	silver	Part Number 85C-R01
	black	Part Number 85C-R02

Accessories see page **Ea-5**



## KarryKrimp®

Modular bench mounted crimpers for braided and multispiral hoses

- A single crimping unit can be either portable or bench mounted
- Faster cycle times on bench mounted units
- Increased height enables longer bent tube fittings to be crimped
- Cylinder maintenance on the Karrykrimp 2 is now possible

**New**



## Modular Design with all the familiar Parkrimp System

Parker's Hose Products Division Europe introduces two new Parkrimp-style modular crimpers – KarryKrimp 1 and the KarryKrimp 2. The new modular design enables the customer to choose between the portability that Parker KarryKrimp crimpers have always offered, and the new option to make these same crimpers bench mounted units.

The modular design gives users the flexibility of a portable crimper with the advantage of increased productivity when connected to the stationary power unit 85CE-1PH.

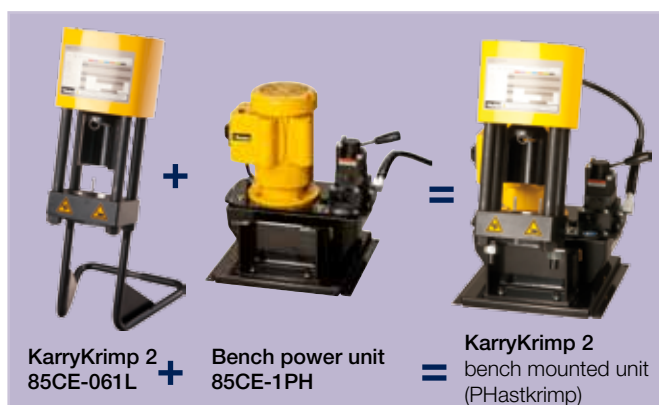
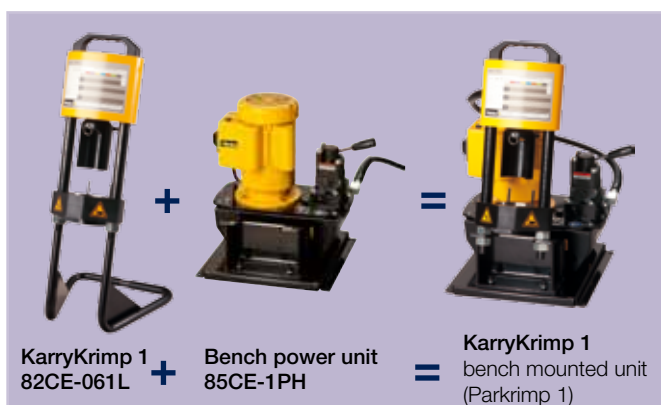

### Technical / Order Data

Bench power unit  
85CE-1PH



Working pressure	70 MPa
Dimensions	L 500 x W 450 x H 475
Weight	59 kg
Usable oil capacity	8000 ccm
Electrical power	230 V / 50/60 Hz / 10 A
<b>Part Number</b>	<b>85CE-1PH</b>

## Parkrimp® 2 Crimping Press 83CE-083U

Bench-mounted crimper for all Parkrimp *No-Skive* hose types from size -4 up to size -32, including 4 and 6 layer multispiral hoses

- Crimps
  - 1 and 2 steel wire or textile braided hoses up to size -32
  - 3 steel wire braided compact up to size -16
  - 4 and 6 layer multispiral hoses up to size -32
  - compact spiral hoses up to size -16
- Used for service with 400 V hydraulic power unit





### Technical / Order Data

**Parkrimp 2** with power unit, bench-mounted, but without die sets, connector plug and oil

Electrical power	400 V / 4.4 kW / 8.9 A / 50 Hz	
Dimensions	H 1170 x W 530 x D 985 mm	
Weight	without packaging	370 kg
	with packaging	430 kg
<b>Part Number</b>	<b>83CE-083U</b>	
<b>Adaptor bowl</b>	<b>Part Number</b>	<b>83C-0CB</b>
<b>Die ring</b>	<b>Part Number</b>	<b>83C-R02</b>

## Accessories for KarryKrimp® 1 and KarryKrimp® 2

For use with Karrykrimp 1 crimping press

Hand pump 82C-2HP		Working pressure	max. 70 MPa
		Dimensions	L 530 x W 121 x H 178 mm
		Weight	4.1 kg
		Usable oil capacity	900 ccm
		Lever force	42 kg
		<b>Part Number</b>	<b>82C-2HP</b>
Air hydraulic pump 82CE-0AP		Working pressure	max. 70 MPa
		Dimensions	L 395 x W 148 x H 145 mm
		Weight	5.5 kg
		Usable oil capacity	590 ccm
		Connection	air 1/4-18 NPTF thread
		<b>Part Number</b>	<b>82CE-0AP</b>

For use with KarryKrimp 1 and KarryKrimp 2 crimping presses

Hand pump 85CE-0HP		Working pressure	max. 70 MPa
		Dimensions	L 560 x W 150 x H 180 mm
		Weight	10.7 kg
		Usable oil capacity	2200 ccm
		Lever force	35 kg
		<b>Part Number</b>	<b>85CE-0HP</b>
Turbo air pump 85C-0AP		Working pressure	70 MPa
		Dimensions	L 350 x W 170 x H 210 mm
		Weight	8.2 kg
		Usable oil capacity	2080 ccm
		Connection	air 1/4-18 NPTF thread
		<b>Part Number</b>	<b>85C-0AP</b>
Power pump 82CE-0EP		Working pressure	70 MPa with 3/2 hand valve
		Dimensions	L 244 x W 244 x H 362 mm
		Weight	10.0 kg
		Usable oil capacity	1900 ccm
		Connection	230 V / 50/60 Hz / 10 A
		<b>Part Number</b>	<b>82CE-0EP</b>
<b>New</b> Bench power unit 85CE-1PH		Working pressure	70 MPa
		Dimensions	L 500 x W 450 x H 475
		Weight	59 kg
		Usable oil capacity	8000 ccm
		Electrical power	230 V / 50/60 Hz / 10 A
		<b>Part Number</b>	<b>85CE-1PH</b>
Hose Assembly 85C-00L Hose assembly to connect pump to the press		Working pressure	max. 70 MPa
		Length	1830 mm
		Port size	3/8-18 NPT male, coupling 3/8"
		<b>Part Number</b>	<b>82C-00L</b>

## Parkrimp® Die Sets

Parker`s Colour-Coded Die Sets

- Chain link keeps segments together
- No loose parts to mismatch or misplace
- The crimp die provides 360-degree gripping power for greater impulse life



**Note:** \*Please consult the pages **Ec** for assembly instructions.  
Die sets with the "H" suffix are used for jump sizes and certain metric fittings to permit insertion and removal of fittings. Die sets 80C-XX 8 segments are chained together. Die sets 83C-XX consist of two chained halves. Exceptions 83C-D06, -D08, -D10, -D12, -D16

Hose I.D. size	DN	Die sets	Part Number								
			26 series	46 series	48 series	70 series	71 series	73/78/79 series	76 series	77 series	S6 series
-4	6	red	80C-E04	80C-B04	80C-C04						
-5	8	violet	80C-E05	80C-B05	80C-C05						
-6	10	yellow	80C-E06	80C-B06	80C-C06	83C-D06	83C-D06				
-8	12	blue	80C-E08	80C-B08	80C-C08	83C-D08	83C-D08			80C-CS08	
-10	16	orange	80C-E10	80C-B10	80C-C10	83C-D10	83C-D10			80C-CS10	
-12	20	green	80C-E12	80C-B12	80C-C12	83C-D12	83C-D12	83C-L12 or 80C-L12	83C-U12	80C-CS12	
-16	25	black	80C-E16	80C-B16	80C-C16	83C-D16 or 83C-D16H	83C-D16 or 83C-D16H	83C-L16 or 80C-L16	83C-U16	83C-CS16	
-20	32	white	83C-E20	80C-B20	80C-C20 or 83C-C20H*		83C-D20 or 83C-D20H*	83C-L20		83C-CS20	
-24	40	red	83C-E24		83C-C24		83C-D24	83C-L24			
-32	50	green	83C-E32		83C-C32		83C-D32	83C-L32			83C-L32

# Hose Cutting Machine EM 10.P

- Cuts
  - 1 steel wire or textile braided hoses up to size -16
  - 2 steel wire braided hoses up to size -12
- Can be used on a workbench or in a vice bench
- Cutting blade covered during use
- Equipped with an electrical safety switch



## Primary Applications

Repair shops or mobile service vehicles, preferably in combination with KarryKrimp 1

## Restrictions

Not suitable for multispiral hoses or large bore industrial hoses.

## Technical / Order Data

### Hose Cutting Machine EM 10.P

with cutting blade, smooth TM 160 x 2,5 x 20

Electric motor	circular saw motor 230 V
Electric power	50/60 Hz / 1200 W / 6100 rpm
Electrical insulation	according VDE KI.II 0740
Radioshielding	according VDE 0875
Cutting blade	160 x 2.5 x 20 mm (HSS)
Dimensions	L 360 x W 340 x H 310 mm
Weight	8 kg
<b>Part Number</b>	<b>EM 10.P</b>
<b>Part Number</b>	<b>TM 160 x 2,5 x 20</b>

Cutting blade, smooth

## Hose Cutting Machine TH 3-2-12VDC

- Cuts
  - 1 and 2 steel wire or textile braided hoses up to size -20
  - 4 steel wire multispiral hoses up to size -16
- For mobile service vehicles with 12 V connection



### Primary Applications

Mobile service vehicles

### Restrictions

Not suitable for large bore hoses.

### Technical / Order Data

<b>Hose Cutting Machine TH 3-2-12VDC</b> with cutting blade, serrated	Electric motor	12 V / 2.4 kW
	Cutting blade	250 x 2 x 40 mm
	Dimensions	W 567 x D 470 x H 365 mm
	Weight	30 kg
	<b>Part Number</b>	<b>TH3-2-12VDC</b>
<b>Cutting blade, serrated 250 x 2 x 40 mm</b>	<b>Part Number</b>	<b>TM250x2x40Z</b>

# Hose Cutting Machine TH 3-2

- Cuts
  - 1 and 2 steel wire or textile braided hoses up to size -32
  - 4 steel wire multispiral hoses up to size -20
- Cutting blade covered during use
- Motor with surface brake and thermo-protection



## Primary Applications

Service in hose workshops and for small series production

## Restrictions

Not suitable for 6 layer multispiral hoses.

## Technical / Order Data

<b>Hose Cutting Machine TH3-2</b> with cutting blade, smooth T891179	Electrical power	400 V / 3.8 kW / 50 Hz
	Exhaust system Ø	50 mm
	Cutting blade	275 x 3 x 30 mm
	Dimensions	L 540 x W 430 x H 300 mm
		with hand lever H 750 mm
	Weight	49 kg
	<b>Part Number</b>	<b>TH3-2</b>
<b>Cutting blade, smooth 275 x 3 x 30 mm</b>	<b>Part Number</b>	<b>T891179</b>
<b>Cutting blade, serrated 275 x 3 x 30 mm</b>	<b>Part Number</b>	<b>T906202</b>

## Hose Cutting Machine TH 3-3

- Cuts
  - 1 and 2 steel wire or textile braided hoses up to size -32
  - 4 steel wire multispiral hoses up to size -32
  - 6 steel wire multispiral hoses up to size -20
- Cutting blade covered during use
- Motor with surface brake and thermo protection



### Primary Applications

Service in hose workshops and for small series production

### Restrictions

Cutting 6 layer multispiral hoses will reduce the service life of the blade.

### Technical / Order Data

<b>Hose Cutting Machine TH3-3</b> with cutting blade, smooth T891180	Electrical power	400 V / 4.4 kW / 50 Hz
	Exhaust system Ø	80 mm
	Cutting blade	350 x 3 x 30 mm
	Dimensions	L 650 x W 550 x H 370 mm with hand lever H 1050 mm
	Weight	75 kg
	<b>Part Number</b>	<b>TH3-3</b>
<b>Cutting blade, smooth 350 x 3 x 30 mm</b>	<b>Part Number</b>	<b>T891180</b>
<b>Cutting blade, serrated 350 x 3 x 30 mm</b>	<b>Part Number</b>	<b>T905871</b>



## Hose Cutting Machine TH 3-13

- 2 motor alternatives: 12 Volt or 400 Volt
- 400 V machine cuts
  - 1 and 2 steel wire or textile braided hoses up to size -32
  - 4 steel wire multispiral hoses up to size -20
- 12 V machine cuts
  - 1 and 2 steel wire or textile braided hoses up to size -20
  - 4 steel wire multispiral hoses up to size -12
- Robust construction, highly reliable and easily to operate
- Smoke evacuation connection (prepared)

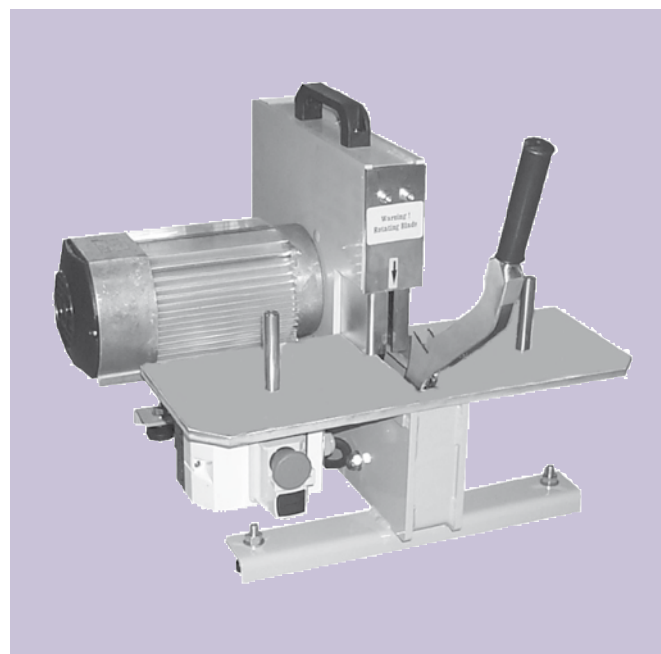

### Primary Applications

Smaller workshops and mobile service vehicles

### Restrictions

12 Volt version, please note the care specification.

### Technical / Order Data

<b>Hose Cutting Machine TH3-13</b>	Max. hose diameter	80 mm
	Exhaust system Ø	63 mm
	Speed	2880 rpm
	Cutting blade	300 x 3 x 50 mm
	Dimensions	L 450 x W 400 x H 430 mm
	Weight	45 kg
<b>Hose Cutting Machine TH3-13 / 3-phase, 400 Volt</b>	Electrical power	400 V / 3.0 kW / 16 A / 50 Hz
	<b>Part Number</b>	<b>TH3-13-3PH</b>
<b>Hose Cutting Machine TH3-13 / 12 Volt</b>	Electrical power	12 V / 1.1 kW
	<b>Part Number</b>	<b>TH3-13-12V</b>
<b>Cutting blade, smooth 300 x 3 x 50 mm</b>	<b>Part Number</b>	<b>TH3-13-BS</b>
<b>Cutting blade, serrated 300 x 3 x 50 mm</b>	<b>Part Number</b>	<b>TH3-13-BT</b>

## Hose Cutting Machine TH 3-14

- Cuts
  - 1 and 2 steel wire or textile braided hoses up to size -32
  - 4 steel wire multispiral hoses up to size -32
  - 6 steel wire multispiral hoses up to size -20
- Very safe operation
- “Open throat” hatch for inserting the hose from the front
- Pre-selection of three different cutting speeds to avoid overheating of the cutting blade
- Variable cutting stroke



### Primary Applications

Service and series production at hose workshops for multispiral hoses and large dimensions

### Restrictions

Not recommended for constant cutting of large-bore 4- or 6-wire multispiral hoses. Not for shorter than 300 mm hose length.

### Technical / Order Data

#### Hose Cutting Machine TH3-14

3-phase, 400 Volt  
with cutting blade, smooth TH3-14-BS

Electrical power	230/400 V / 5.5 kW / 16 A / 50 Hz
Air pressure	min. 0.6 MPa
Counter	0 - 9999 pcs
Max. hose diameter	80 mm
Exhaust system Ø	100 mm
Speed	2850 rpm
Cutting blade	400 x 4 x 50 mm
Dimensions	L 700 x W 600 x H 1300 mm
Weight	140 kg
<b>Part Number</b>	<b>TH3-14-3PH</b>
<b>Part Number</b>	<b>TH3-14-BS</b>
<b>Part Number</b>	<b>TH3-14-BT</b>

**Cutting blade**, smooth 400 x 4 x 50 mm

**Cutting blade**, serrated 400 x 4 x 50 mm

## Hose Cutting Machine TH 3-15

- Cuts
  - all industrial hose types up to 75 mm O.D.
  - 1, 2 and 3 steel wire or textile braided hoses up to size -40
  - 4/6 steel wire multispiral hoses up to size -32
- Extremely strong hydraulic and pneumatic operation for heavy duty series production
- “Open throat” hatch for inserting from the front
- Pneumatic hose pre-bending system (3 different cutting strokes)
- Motor controlled cutting blade brake
- Variable cutting speed control to avoid overheating of the blade

### Primary Applications

Service and series production at workshops.

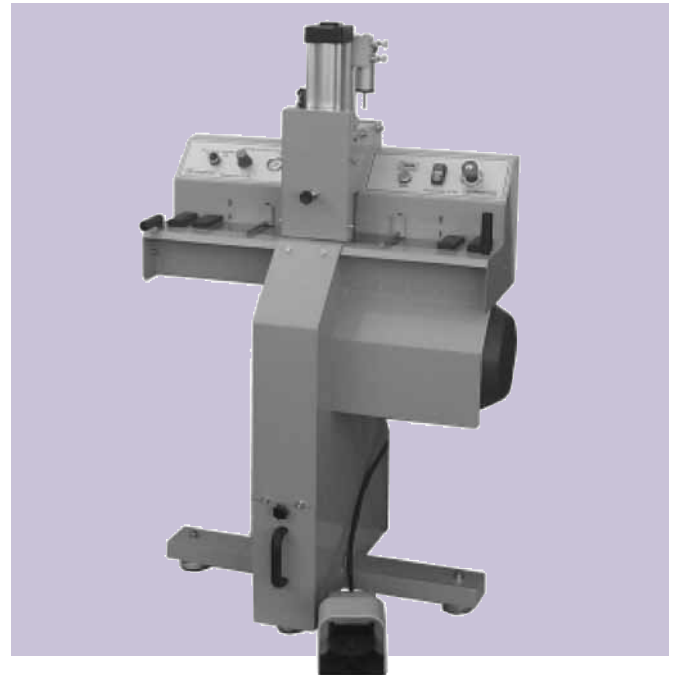

### Restrictions

Not for shorter than 300 mm hose length.

### Technical / Order Data

#### Hose Cutting Machine TH3-15 3-phase, 400 Volt

Electrical power	230/400 V / 7.5 kW / 25 A / 50 Hz
Air pressure	min. 0.6 MPa
Counter	0 - 9999 pcs
Max. hose diameter	75 mm
Exhaust system Ø	100 mm
Speed	2850 rpm
Cutting blade	520 x 4 x 38 / 50 mm
Dimensions	L 900 x W 645 x H 1500 mm
Weight	210 kg
<b>Part Number</b>	<b>TH3-15-3PH</b>
<b>Part Number</b>	<b>TH3-15-BS</b>
<b>Part Number</b>	<b>TH3-15-BTF</b>
<b>Part Number</b>	<b>TH3-15-BTS</b>
<b>Part Number</b>	<b>TH3-15-BAR</b>

<b>Cutting blade</b> , smooth 520 x 4 x 38 mm
<b>Cutting blade</b> , serrated 520 x 4 x 38 mm
<b>Cutting blade</b> , serrated 520 x 4 x 50 mm
<b>Adapter ring</b> 50 x 38 mm

## Marking Machines TH 4-7, TH 4-8

- Manually or pneumatically driven
- Suitable for marking all 1- and 2-piece fittings series up to size -32

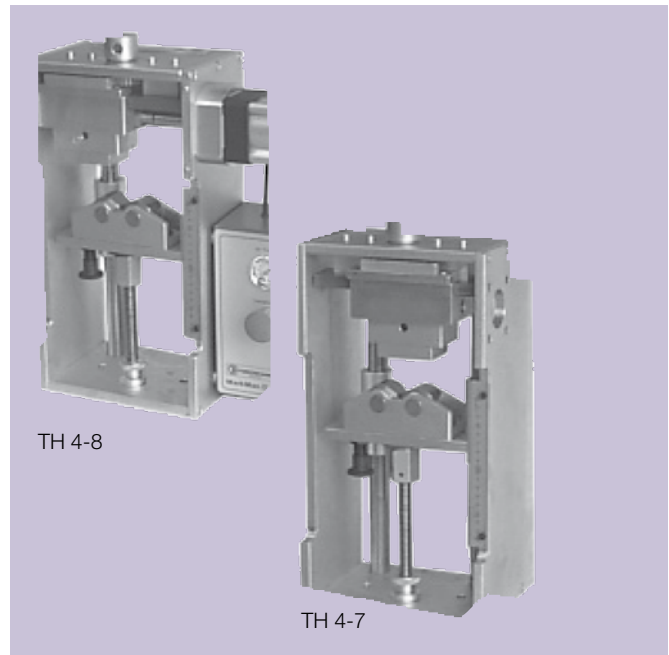

### Primary Applications

Smaller workshops and mobile service vehicles

### Technical / Order Data

<b>Marking Machine TH 4-8</b> manual excl. QC-adapter, type case and type holder	Colour	zinc plated
	Dimensions	L 500 x W 200 x H 500 mm
	Weight	28 kg
	<b>Part Number</b>	<b>TH4-8</b>
<b>Marking Machine TH 4-7</b> pneumatic excl. QC-adapter, type case and type holder	Colour	zinc plated
	Air pressure	min. 0.6 MPa
	Dimensions	L 500 x W 380 x H 500 mm
	Weight	35 kg
<b>Type case</b> 3 mm	<b>Part Number</b>	<b>TH4-9</b>
<b>Type print holder</b> 2 lines	<b>Part Number</b>	<b>TH4-9-1</b>
<b>QC-adapter</b> for type print holder	<b>Part Number</b>	<b>TH4-10</b>

Type holder  
2 lines

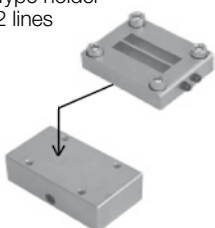

QC-adapter



Type case

#### Type case TH 4-9 content

AAABBCCDDEEEFFGGHHIIJJKK  
 LLLMMNNNOOOPPQQRRRSSSTT  
 UUUUVWXYZ//...,11112222333344  
 44556667778889990000 and 20 pcs of blanks  
 + mirror

## Hand Marking Tools TH 4-4 U, TH 4E-11

- Hand marking tool for marking the crimp shells of 1- and 2-piece fittings up to size -32
- Permanent and easy marking in hose assembling workshops
- Type holder with two lines makes it possible to print additional information on the shell or fittings

### TH 4E-11

- The cost efficient alternative



### Primary Applications

Workshops and mobile service vehicles

### Technical / Order Data

<b>Hand Marking Tool TH 4-4 U</b> including type case and quick-change stamping tool	Marking area	Ø O.D. 11.5 mm - 100 mm
	Dimensions	L 250 x W 340 x H 450 mm
	Type holder	2 lines
	Weight	35 kg
	<b>Part Number</b>	<b>TH4-4U</b>
<b>Type case for TH 4-4 U</b>	<b>Part Number</b>	<b>UPTS 100</b>
<b>Quick-change stamping tool for TH 4-4 U single line</b>	<b>Part Number</b>	<b>UPTH-11b-PW3</b>
<b>Type holder for TH 4-4 U 2 lines</b>	<b>Part Number</b>	<b>UPTH-22b</b>
<b>Hand Marking Tool TH 4E-11</b> including type case and type holder	Marking area	Ø O.D. 8 mm - 80 mm
	Dimensions	L 285 x W 265 x H 410 mm
	Type holder	1 line
	Weight	12 kg
	<b>Part Number</b>	<b>TH4E-11</b>
<b>Type case for TH 4E-11</b>	<b>Part Number</b>	<b>TH4E-11-TC</b>
<b>Type holder for TH 4E-11</b>	<b>Part Number</b>	<b>TH4E-11-TH</b>



Stamping tool  
UPTH-11b-PW3

#### Type case UPTS 100 content

Letters: 1x P, 1x N, 3x letters empty  
Numbers: 6 x 1; 5 x 2,3,4,5; 4 x 6; 3 x 7,8,9; 4 x 0  
Neutral: 1x 15 mm, 1x 30 mm + brush, tweezers, key

#### Type case TH4E-11-TC content

Letters: 1x P, 1x N, 3x letters empty  
Numbers: 6 x 1; 5 x 2,3,4,5; 4 x 6; 3 x 7,8,9; 4 x 0  
Neutral: 1x 15 mm, 1x 30 mm + brush, tweezers, key

## Cleaning System TH 6-6

- Cleaning device for hose and hose assemblies for hoses up to size -20
- Assemblies flushed with fluid and blown out with air
- Defined cleanliness levels can be achieved
- Air connection min. 0.7 MPa required

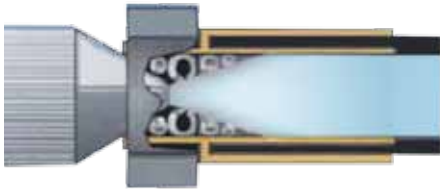

### Technical / Order Data

	Air pressure	min. 0.7 MPa
	Flow	8 l/min
	Air consumption	max. 100 NI/min
	Length	(depending on I.D.) max. 2.5 m
	Dimensions	L 960 x W 435 x H 940 mm
	Weight	55 kg
	with cleaning fluid	93 kg
<b>Cleaning Machine TH 6-6</b>	<b>Part Number</b>	<b>TH6-6</b>
<b>Filter set without cartridges</b>	<b>Part Number</b>	<b>H899959</b>
<b>Filter cartridges 5 µm</b>	<b>Part Number</b>	<b>600.4</b>
<b>Neutral cleaning fluid additive (30 litre drum)</b>	<b>Part Number</b>	<b>H899771</b>

## Cleaning System TH 6-7

- Quick and simple system using compressed air to clean hoses
- Delivered with two plastic nozzles for hoses from size -4 up to -32.

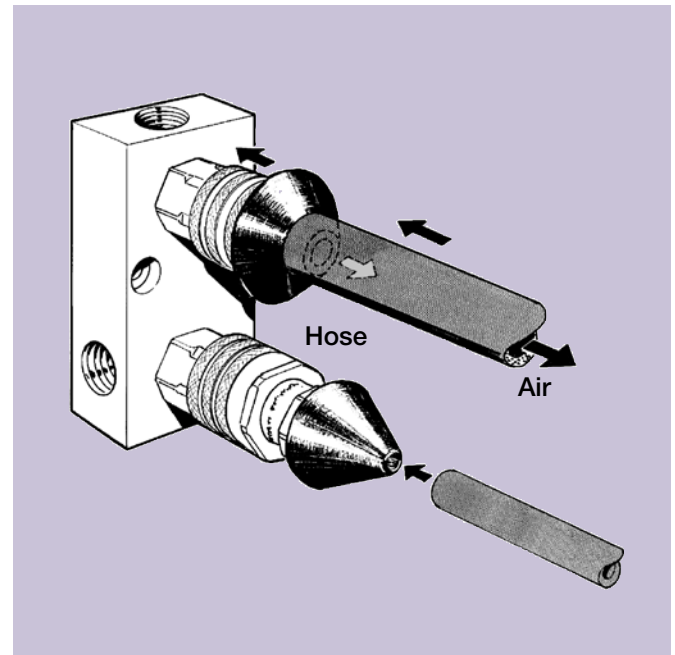

### Application

The hose is pressed against the nozzle and thereby opens a valve to allow the compressed air to blow through the hose and blow out loose particles.

### Technical / Order Data

<b>Cleaning System TH 6-7</b> with two plastic nozzles in 30 and 55 mm	Air pressure	min. 0.6 MPa
	Air connection	1/2" BSP
	Dimensions	L 120 x W 50 x H 100 mm
	Weight	0.3 kg
	<b>Part Number</b>	<b>TH6-7</b>
<b>Nozzle 30 mm</b>	<b>Part Number</b>	<b>TH6-7-30</b>
<b>Nozzle 55 mm</b>	<b>Part Number</b>	<b>TH6-7-55</b>

## Ultra Clean Kit TH 6-10-EL-7

Removes contaminants from inside hose assemblies

- Cleaning size -4 up to size -20 hose
- Reduces downtime and risk of hose failure
- Has a quarter-turn locking ring for easy nozzle change and projectile loading
- Durable brass and aluminium internals, strong plastic handle, and anodized aluminium firing head and locking ring



Economy Kit  
 TH6-10-EL-7

### Primary Applications

Workshops and mobile service vehicles

### Restrictions

5 micron filter and regulator with gauge are strongly suggested

### Technical / Order Data

**Ultra Clean Kit TH 6-10-EL-7** with case, launcher in size -20, nozzles in size -4, -6, -8, -10, -12, -16 and -20 (1 each)

Air pressure	min. 0.55 MPa max. 0.75 MPa
Air connection	1/2" I.D. air hose
Dimensions	L 407 x W 134 x H 343 mm
Weight	4 kg
<b>Part Number</b>	<b>TH6-10-EL-7</b>

**Nozzles and Projectiles** for Ultra Clean Kit TH6-10-EL-7

Hose Size	Nozzle Part Number	Projectile Part Number
-4	<b>TH6-10-H06</b>	<b>TH6-10-P10</b>
-5	<b>TH6-10-H08</b>	<b>TH6-10-P12</b>
-6	<b>TH6-10-H10</b>	<b>TH6-10-P14</b>
-8	<b>TH6-10-H13</b>	<b>TH6-10-P18</b>
-10	<b>TH6-10-H16</b>	<b>TH6-10-P22</b>
-12	<b>TH6-10-H19</b>	<b>TH6-10-P26</b>
-16	<b>TH6-10-H25</b>	<b>TH6-10-P33</b>
-20	<b>TH6-10-H32</b>	<b>TH6-10-P40</b>



## Ultra Clean Kit TH 6-10-HL-9-2

Removes contaminants from inside hose assemblies

- Cleaning size -4 up to size -32 hose
- Reduces downtime and risk of hose failure
- Full-flow quick release coupling and unique 360° rotary plug for proper air flow and non-fatigue operator use
- Aluminium, fully anodized for harsh environments and heavy use
- Unique safety release bar that locks the faceplate into a closed position for firing Ultra Clean projectiles



### Primary Applications

Workshops and mobile service vehicles

### Restrictions

5 micron filter and regulator with gauge are strongly suggested

### Technical / Order Data

**Ultra Clean Kit TH 6-10-HL-9-2** with case, launcher in size -32, nozzles in size -4, -6, -8, -10, -12, -16, -20, -24 and -32 (1 each)

Air pressure	min. 0.55 MPa max. 0.75 MPa
Air connection	1/2" I.D. air hose
Dimensions	L 407 x W 134 x H 343 mm
Weight	5 kg
<b>Part Number</b>	<b>TH6-10-HL-9-2</b>

**Nozzles and Projectiles** for Ultra Clean Kit TH6-10-HL-9-2

Hose Size	Nozzle Part Number	Projectile Part Number
-4	<b>TH6-10-H06</b>	<b>TH6-10-P10</b>
-5	<b>TH6-10-H08</b>	<b>TH6-10-P12</b>
-6	<b>TH6-10-H10</b>	<b>TH6-10-P14</b>
-8	<b>TH6-10-H13</b>	<b>TH6-10-P18</b>
-10	<b>TH6-10-H16</b>	<b>TH6-10-P22</b>
-12	<b>TH6-10-H19</b>	<b>TH6-10-P26</b>
-16	<b>TH6-10-H25</b>	<b>TH6-10-P33</b>
-20	<b>TH6-10-H32</b>	<b>TH6-10-P40</b>
-24	<b>TH6-10-H38</b>	<b>TH6-10-P50</b>
-32	<b>TH6-10-H50</b>	<b>TH6-10-P60</b>

## Hose Assembly Test Bench TH 5-3

Pressure test bench up to 145.0 MPa

- Totally sealed test chamber
- Safety interlock – pressure automatically decreases within 1/10 sec. when the test chamber is opened
- Rapid fill and automatic air bleeding of the test piece
- Weight-compensated protection cover with safety windows
- Bio-degradable water-oil emulsion as test medium
- Simple operation



### Primary Applications

Service and series production in workshops. The hose assembly test bench makes the efficient and safe final inspection of hose assemblies practical and fast. Static pressure testing of other hydraulic components is also possible.

### Restrictions

This test bench is not designed for burst pressure testing. Due to the limited flexibility of large bore multispiral hoses it is not ideal for size -24 and size -32 pressure testing.

### Technical / Order Data

#### Hose Assembly Test Bench TH 5-3 incl. HD adapter set

Test pressure	12.0 - 145.0 MPa	
Drive	intensifier	
Compressed air rating	0.7 MPa, 20 NI/min	
Pressure regulator	manual	
Test medium	water-oil emulsion	
Safety control unit	yes	
Tank capacity	100 l	
Colour	black / silver	
Dimensions	L 2210 x W 840 x H 1260 mm	
Weight	empty	210 kg
	with medium	310 kg
Accessories	filter 100 µm, air service unit	
<b>Part Number</b>	<b>TH5-3</b>	

#### Hose Assembly Test Bench TH 5-3 with result recording unit

**Part Number** TH5-3-BM

#### HD adapter set

**Part Number** 405.906

#### Corrosion protection, 10 l

**Part Number** H899770

## Hose Reel TH 7-12

- Seven-stage reel for hoses size -4 to -20
- Every stage (except bottom stage) can be swung out horizontally so that new rolls can easily be inserted

### Technical / Order Data

#### Hose Reel TH 7-12

for service and series production in workshops



Reel dimensions	
Int. Ø min. / max.	250 mm / 1010 mm
Height max.	300 mm
Max. load per reel	80 kg
Colour	zinc plated
Dimensions	L 1270 x W 1000 x H 2230 mm
Weight	148 kg
<b>Part Number</b>	<b>TH7-12</b>

## Hose Reel TH 7-13

- One-stage reel for hoses size -4 to -32
- Table adjustable to fit the center of the coil

### Technical / Order Data

#### Hose Reel TH 7-13

for service and series production in workshops

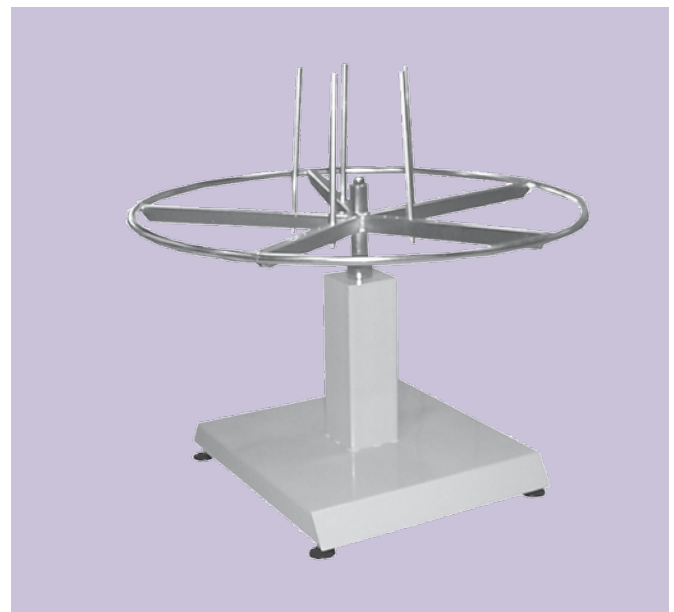

Reel dimensions	
Int. Ø min. / max.	adjustable 150 - 500 mm
Max. load of reel	500 kg
Colour	zinc plated / grey
Dimensions	L 1200 x W 1200 x H 830 mm
Weight	40 kg
<b>Part Number</b>	<b>TH7-13</b>

## Hose Reel TH 7-14

Horizontal motorized reel

- Motorized reel for hoses size -4 to -32
- Variable speed control in both directions
- Ideal for cutting long lengths where coiling is necessary

Technical / Order Data

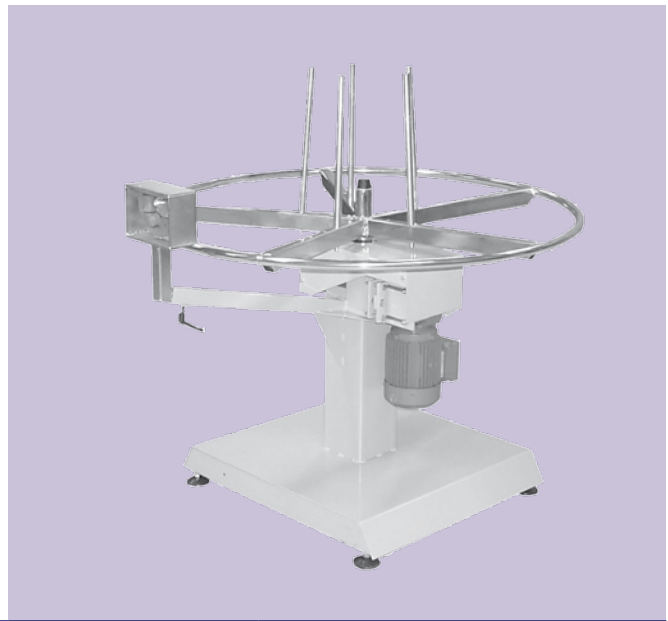

**Hose Reel TH 7-14**  
for service and series production in workshops

Reel dimensions	
Int. Ø min. / max.	adjustable 150 - 500 mm
Max. load of reel	500 kg
Electric power	230 V / 10 A / 50 Hz
Colour	zinc plated / light grey
Dimensions	W 1200 x H 830 mm
Weight	65 kg
<b>Part Number</b>	<b>TH7-14</b>

## Hose Reel TH 7-15

Vertical motorized reel

- Motorized reel for hoses size -4 to -20
- Variable speed control in both directions
- Ideal for cutting long lengths where coiling is necessary
- Very easy to unload

Technical / Order Data

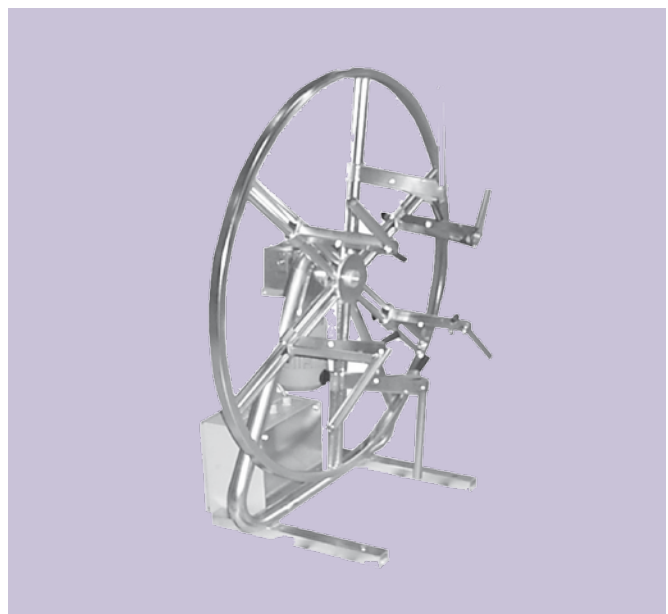

**Hose Reel TH 7-15**  
for service and series production in workshops

Reel dimensions	
Int. Ø min. / max.	adjustable 250 - 800 mm
Max. load of reel	100 kg
Electric power	230 V / 10 A / 50 Hz
Colour	zinc plated
Dimensions	W 600 x H 1400 mm
Weight	75 kg
<b>Part Number</b>	<b>TH7-15</b>

## Crimping Press TH 8E-530, TH 8E-535-BM

- Strong crimping machine for all Parker *No-Sliver* hose up to size-32
- Easy installation on the workbench in the workshop area or in the van
- For die sets series 239L and 266 (adapter die set PB266.239L required)

### Primary Applications

Hose assembly workshops with small series production and services at certified distributors, ParkerStores and hose workshops in the maintenance areas at OEM customers



### Restrictions

Not for ParLock hose fittings in size -20, -24 and -32 (fittings series V4 and V6).

<b>All TH 8E-530 and TH 8E-535</b> with	Crimp force	200 t
	Crimp range	94 mm
– adapter die set PB266.239L	Noise level	69 dBA
– die set packet (14 mm – 74 mm) PBSET-TH8E-53X	Colour	black/silver
– quick change tool QDC239.3	Electrical power	400 V / 50 Hz / 3 PH / 4 kW
	Control system	micrometer
<b>TH 8E-530</b>	Dimensions	L 700 x W 600 x H 735 mm
	Oil quantity	50 l
	Weight	248 kg
	<b>Part Number</b>	<b>TH8E-530</b>
	Electrical power	400 V / 50 Hz / 3 PH / 4 kW
<b>TH 8E-530-BM</b>	Control system	B-Touch
	Dimensions	L 700 x W 600 x H 735 mm
	Oil quantity	50 l
	Weight	255 kg
	<b>Part Number</b>	<b>TH8E-530-BM</b>
<b>TH 8E-530-12VDC</b>	Electrical power	12 V DC
	Control system	micrometer
	<b>Part Number</b>	<b>TH8E-530-12VDC</b>
	Electrical power	400 V / 50 Hz / 3 PH / 5.5 kW
<b>TH 8E-535-BM</b>	Control system	B-Touch
	Dimensions	L 690 x W 600 x H 1053 mm
	Oil quantity	55 l
	Weight	375 kg
	<b>Part Number</b>	<b>TH8E-535-BM</b>
<b>Adapter die set</b>	<b>Part Number</b>	<b>PB266.239L</b>
<b>Die rack</b>	<b>Part Number</b>	<b>QDS239S</b>
<b>Die set packet, diameter from 14 – 74 mm</b>	<b>Part Number</b>	<b>PBSET-TH8E-53X</b>
<b>Quick change tool</b>	<b>Part Number</b>	<b>QDC239.3</b>

## Crimping Press TH 8-800-BM

- Suitable for all the Parker *No-Skive* fittings up to size -32 and industrial hose types up to 4"
- Hydraulic hose SAE 100 R13 and SAE 100 R15 up to size -32 with Parker-No Skive fittings
- ParLock hose fittings V4 and V6 series up to size -20 (DN 32 for SAE 100R15)
- Adjustable crimper electronic system B and 3 different crimp programs, manual opening and closing, semi-automatic opening and closing with foot switch or depth stop
- It is possible to crimp small diameters with an adapter die set



### Primary Applications

Hose assembly workshops with small series production and services at certified distributors, ParkerStores and hose workshops in the maintenance areas at OEM customers

### Restrictions

Not for ParLock hose fittings in size -24 and size-32 (fittings series V4 and V6).

There could be interference with long drop elbow fittings.

### Technical / Order Data

#### Crimping Press TH 8-800-BM with

- adapter die set PB237.239.2L2
- quick change tool QDC239.3
- die set packet (12 mm – 74 mm) PBSET-TH8-800

Attention: Delivery without oil or connecting plug

Electrical power	400 V / 50 Hz / 3 PH / 4 kW
Crimp force	220 t
Control system	B-Touch
Crimp range	139 mm
Noise level	69 dB (A)
Colour	black/silver
Dimensions	L 690 x W 600 x H 1400 mm
Oil tank capacity	55 l
Weight	without oil 390 kg with oil 445 kg

<b>Adapter die set</b>	<b>Part Number</b>	<b>TH8-800-BM</b>
<b>Depth stop</b>	<b>Part Number</b>	<b>PB237.239.2L2</b>
<b>Die rack</b>	<b>Part Number</b>	<b>TA800/A</b>
<b>Die set packet, diameter from 12 – 74 mm</b>	<b>Part Number</b>	<b>QDS239S</b>
<b>Foot switch</b>	<b>Part Number</b>	<b>PBSET-TH8-800</b>
<b>Mirror set</b>	<b>Part Number</b>	<b>FU-HMX</b>
<b>Quick change tool</b>	<b>Part Number</b>	<b>SHS-800</b>
		<b>QDC239.3</b>

## Heavy-Duty Crimping Press TH 8E-380-BM

- Heavy-duty crimper for crimping all Parker/ParLock hose types up to 4 or 6 spiral steel wire layers (DIN 4SP/4SH, SAE 100 R13 and SAE 100R15) up to size -32
- Crimps all Parker industrial hose types up to 4" (DN 100)



### Primary Applications

Heavy-duty crimper for crimping multispiral hoses in workshops for series production.  
Suitable for all standard Parker hoses.

### Restrictions

Special hose fittings with 2 elbows in extremely long version.

### Technical / Order Data

#### Heavy-Duty Crimping Press TH 8E-380-BM with

- adapter die set PB237.239.2L2
- quick change tool QDC239.3
- die set packet (14 - 78 mm) PBSET-TH8E-380

For V4 and V6 fittings above size -16 long die sets are required (e.g. PB 237L-57)

Attention: Delivery without oil and without connecting plug

Electrical power	3 PH / 400 V / 50 Hz / 5.5 kW
Crimp force	340 t
Control system	B-Touch
Crimp range	161 mm
Open / Close speed	23 mm/s
Noise level	69 dB (A)
Dimensions	L 1600 x W 600 x H 1600 mm
Weight	without oil 750 kg with oil 840 kg

<b>Part Number</b>	<b>TH8E-380-BM</b>
<b>Depth stop</b>	<b>Part Number TA380/A</b>
<b>Adapter die set</b>	<b>Part Number PB237.239.2L2</b>
<b>Die rack</b>	<b>Part Number QDS239S</b>
<b>Die set packet, diameter from 14 – 78 mm</b>	<b>Part Number PBSET-TH8E-380</b>
<b>Die set packet, diameter from 84 – 131 mm</b>	<b>Part Number PBSET-237L-IH</b>
<b>Foot switch</b>	<b>Part Number FU-HMX</b>
<b>Mirror set</b>	<b>Part Number SHS310/370</b>
<b>Quick change tool</b>	<b>Part Number QDC239.3</b>
<b>Workplace lamp</b>	<b>Part Number TH8-LUS</b>

# Hose Skiving Machine TH 2-9

- For efficient skiving of hydraulic hoses (external and internal) from dimensions size -4 up to -32
- The machine is easily controlled by a footpedal
- Waste collection bin



## Primary Applications

For small series and service application.

## Restrictions

Not recommended for series production.

## Technical / Order Data

### Hose Skiving Machine TH 2-9 without skiving tools

Hose capacity, external skiving	4 and 6 layer	size -4 up to -32
Hose capacity, internal skiving	4 and 6 layer	size -6 up to -32
Speed	125 rpm	
Colour	light grey	
Dimensions	L 600 x W410 x H 390 mm	
Weight	35 kg	

### Hose Skiving Machine TH 2-9-3PH 3 phases, 400 V

Electrical power	3 PH / 400 V / 50 Hz / 16 A / 0.37 kW	
<b>Part Number</b>	<b>TH2-9-3PH</b>	

### Hose Skiving Machine TH 2-9-1PH 1 phase, 230 V

Electrical power	1 PH / 230 V / 50 Hz / 10 A / 0.37 kW	
<b>Part Number</b>	<b>TH2-9-1PH</b>	

Skiving tools see page **Ea-29**



Internal  
skiving tool



External  
skiving tool  
with one external tool



## Hose Skiving Machine TH 2-10-3PH

- Efficient external and internal skiving
- Semi-automatic electro-pneumatic control-system
- Adjustable pressure and speed
- Automatic self-centering system
- Waste collection bin



### Primary Applications

Mainly for hose assembly workshop production for medium and large series up to size -32.

### Restrictions

Work cycle for internal and external skiving takes place separately, not in one step.

### Technical / Order Data

#### Hose Skiving Machine TH 2-10-3PH without skiving tools

Hose capacity, external skiving	
4 and 6 layer	size -4 up to -32
Hose capacity, internal skiving	
4 and 6 layer	size -6 up to -32
Speed	315 rpm
Air pressure	min. 0.7 MPa
Colour	light grey
Electrical power	3 PH / 400 V / 50 Hz / 16 A / 1.2 kW
Dimensions	L 680 x W1200 x H 1080 mm
Weight	132 kg
<b>Part Number</b>	<b>TH2-10-3PH</b>

Skiving tools see page **Ea-29**



Internal  
skiving tool



External  
skiving tool  
with two external tools

## Twin-Skive Machine TH 2-13-3PH

- Twin-Skive machine for quick internal and external skiving in one operation
- Semi-automatic electro-pneumatic control-system
- Automatic self-centring system
- Adjustable pressure and speed
- Waste collection bin
- Eliminates work-related injuries

### Primary Applications

For hose assembly workshops for series production up to size -32



### Restrictions

Max. hose outside diameter 75 mm for external skiving.

### Technical / Order Data

#### Hose Skiving Machine TH 2-13-3PH without skiving tools

Hose capacity, external skiving	
4 and 6 layer	size -4 up to -32
Hose capacity, internal skiving	
4 and 6 layer	size -6 up to -32
Speed	400 / 315 rpm
Air pressure	min. 0.7 MPa
Colour	light grey
Electrical power	3PH/400V/50Hz/16A/2x0.75 kW
Dimensions	L 680 x W1200 x H 1080 mm
Weight	150 kg
<b>Part Number</b>	<b>TH2-13-3PH</b>

Skiving tools see page **Ea-29**

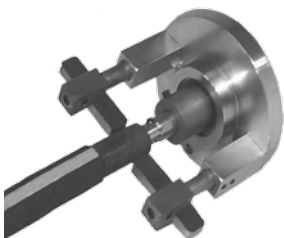

Skiving tool

## Skiving tools for TH 2-9, TH 2-10-3PH and TH 2-13-3PH

Internal skiving tool for TH 2-9 and TH 2-10-3PH

Internal skiving tool TH 2-9 and TH 2-10-3PH	size	Internal skiving tool (without knife)	Internal skiving knife
		Part Number	Part Number
 A: Internal skiving knife	-10	<b>TH2-12NT-10</b>	<b>TH2-12NK-1012</b>
	-12	<b>TH2-12NT-12</b>	
	-16	<b>TH2-12NT-16</b>	<b>TH2-12NK-1620</b>
	-20	<b>TH2-12NT-20</b>	
	-24	<b>TH2-12NT-24</b>	<b>TH2-12NK-2432</b>
	-32	<b>TH2-12NT-32</b>	

External skiving tool for TH 2-9 and TH 2-10-3PH

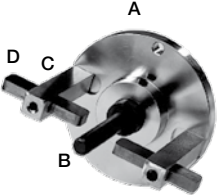
External skiving tool TH 2-9 and TH 2-10-3PH	size	Mandrel Size	External skiving tool (without knife)	Additional arm	External skiving knife
		Part Number	Part Number	Part Number	Part Number
 A: External skiving tool holder B: Mandrel for external skiving C: Holder for skiving tool D: External skiving knife	-4	<b>TH2-11M-4</b>	short arm <b>TH2-11ES</b>	short arm <b>TH2-11ES-1</b> TH2-10-3PH only	<b>TH2-11EK</b>
	-6	<b>TH2-11M-6</b>			
	-8	<b>TH2-11M-8</b>			
	-10	<b>TH2-11M-10</b>			
	-12	<b>TH2-11M-12</b>			
	-16	<b>TH2-11M-16</b>	long arm <b>TH2-11EL</b>	long arm <b>TH2-11EL-1</b> TH2-10-3PH only	
	-20	<b>TH2-11M-20</b>			
	-24	<b>TH2-11M-24</b>			
	-24	<b>TH2-11M-24</b>			
	-32	<b>TH2-11M-32</b>			

Internal and external skiving tool for TH 2-13-3PH

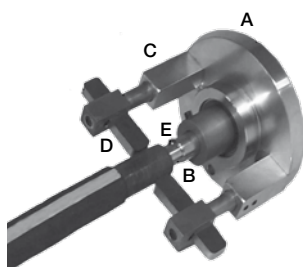

Skiving tool  
 A: Tooling holder complete  
 B: Mandrel for internal skiving  
 C: Holder for external skiving knife  
 D: External skiving knife  
 E: Internal skiving knife

Internal and external skiving tool TH 2-13-3PH	size	Mandrel Size	Internal skiving knife	External skiving toolholder	Additional arm	External skiving knife
		Part Number	Part Number	Part Number	Part Number	Part Number
	-8	<b>TH2-13M-8</b>	<b>TH2-12NK-8</b>	<b>TH2-13ET</b>	short arm <b>TH2-13ES-1</b>	<b>TH2-11EK</b>
	-10	<b>TH2-13M-10</b>	<b>TH2-12NK-1012</b>			
	-12	<b>TH2-13M-12</b>				
	-16	<b>TH2-13M-16</b>	<b>TH2-12NK-1620</b>		long arm <b>TH2-13EL-1</b>	
	-20	<b>TH2-13M-20</b>				
	-24	<b>TH2-13M-24</b>	<b>TH2-12NK-2432</b>			
	-32	<b>TH2-13M-32</b>				



# Flange Half

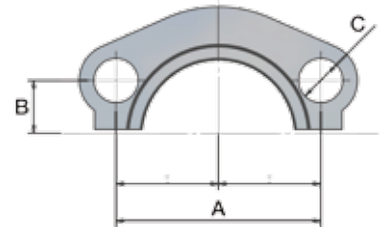



## M1H / 51H – SAE code 61 Flange Half – Standard Series

ISO 6162

Part Number	 Flange			A mm	B mm	C mm	 max. dynamic working pressure	
	DN	Inch	Size				MPa	psi
M1H-8	13	1/2	-8	38.1	8.7	9.0	34.5	5000
M1H-12	19	3/4	-12	47.6	11.1	11.0	34.5	5000
M1H-16	25	1	-16	52.4	13.1	11.0	34.5	5000
51H-20	32	1-1/4	-20	58.7	15.1	12.0	27.5	4000
51H-24	38	1-1/2	-24	69.9	17.9	13.5	21.0	3000
51H-32	51	2	-32	77.7	21.4	13.5	21.0	3000



## 50H – 5000 psi code 61 Flange Half

ISO 6162 (For use with 4A, 4F and 4N flanges)



Part Number	 Flange			A mm	B mm	C mm	 max. dynamic working pressure	
	DN	Inch	Size				MPa	psi
50H-20	32	1-1/4	-20	58.7	15.1	12.0	34.5	5000
50H-24	40	1-1/2	-24	69.9	17.9	13.5	34.5	5000
50H-32	50	2	-32	77.7	21.4	13.5	34.5	5000

## M2H – SAE code 62 Flange Half – Heavy Series

ISO 6162

Part Number	 Flange			A mm	B mm	C mm	 max. dynamic working pressure	
	DN	Inch	Size				MPa	psi
M2H-8	13	1/2	-8	40.5	9.1	9.0	41.0	6000
M2H-12	19	3/4	-12	50.8	11.9	11.0	41.0	6000
M2H-16	25	1	-16	57.2	13.9	13.0	41.0	6000
M2H-20	32	1-1/4	-20	66.6	15.9	15.0	41.0	6000
M2H-24	38	1-1/2	-24	79.2	18.2	17.0	41.0	6000
M2H-32	51	2	-32	96.8	22.2	22.0	41.0	6000

## 8FH – Flange Half 8000 psi

Part Number	 Flange			A mm	B mm	C mm	 max. dynamic working pressure	
	DN	Inch	Size				MPa	psi
8FH-12-SM	20	3/4	-12	50.80	10.90	11.0	56.0	8000
8FH-12	20	3/4	-12	50.80	10.90	10.4	56.0	8000
8FH-16-SM	25	1	-16	57.15	12.95	13.0	56.0	8000
8FH-16	25	1	-16	57.20	13.00	11.9	56.0	8000
8FH-20-SM	32	1-1/4	-20	66.70	15.00	13.0	56.0	8000

On request

Full flanges code 61 and 62, flange kits, flanges for inch bolts



## Full Flange System

Provides full flange mounting option for 3000 psi (Code 61) and 6000 psi (Code 62) ports. System flexibility reduces inventory investment.



Once the hose fitting is crimped to the hose, the flange is placed over the fitting end and then is held in place with the retaining ring. When the flange engages the retaining ring, the flange is held securely and is ready to be bolted to the port. Installation to the port is easy – there is no fumbling with the flange halves, and the flange can be rotated for ease of assembly to the port. The full flange system can be used repeatedly because of its patent-pending attachment system – the flange is not permanently locked onto the fitting.

### Flange System

Code 61 port – all sizes rated for 5000 psi

SAE Flange Size (Inch)	Max. Working Pressure	Flange Part Number	Seal Part Number	Retaining Ring Part Number
3/4	5000	R312-35-CFX	XRG-12	R12X
1	5000	R316-CFX	XRG-16	R16X
1-1/4	5000	R320-12.5-CFX	XRG-20	R20X
1-1/2	5000	R324-CFX	XRG-24	R24X
2	5000	R332-CFX	XRG-32	R32X

Code 62 port – 6000 psi

SAE Flange Size (Inch)	Max. Working Pressure	Flange Part Number	Seal Part Number	Retaining Ring Part Number
3/4	6000	R612-35-CFX	XRG-12	R12X
1	6000	R616-CFX	XRG-16	R16X
1-1/4	6000	R620-CFX	XRG-20	R20X
1-1/2	6000	R624-CFX	XRG-24	R24X
2	6000	R632-CFX	XRG-32	R32X

The stainless steel retaining rings and O-rings are recommended for one-time use.

Details see page **Ab-39**

# Banjo Bolt

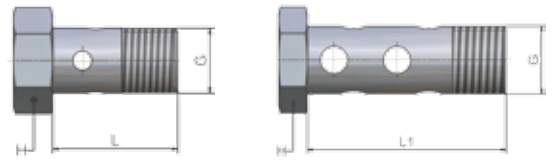

## AM/AR – Banjo Bolt (DIN 7643)

Part Number Single	Part Number Double	I.D. Banjo mm	G Thread metric / Inch	L Single mm	L1 Double mm	H mm
AM3	A2M3	8	M8x1	17	26	12
AM4	A2M4	10	M10x1	19	30	14
AR4		10	1/8	19		14
AM6	A2M6	12	M12x1.5	24	38	17
AM8	A2M8	14	M14x1.5	26	41	19
AR8		14	1/4	26		19
AR-08C		14	1/4	26		19
AM10	A2M10	16	M16x1.5	28	46	22
AR10		17	3/8	29		22
AM13		18	M18x1.5	32		24
AM16		22	M22x1.5	39		27
AR16		22	1/2	39		27
AM20		26	M26x1.5	45		32
AR20		27	3/4	45		32

Material: chromium(VI)-free plated steel

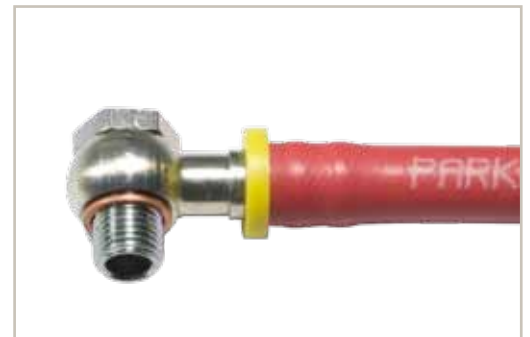

Complete banjo fitting

## 853009 – Copper Ring (Form A DIN 7603)

Part Number	I.D. Banjo mm	G Thread metric / Inch
853009-8	8	M8x1
853009-10	10	M10x1
853009-10	10	1/8
853009-12	12	M12x1.5
853009-14	14	M14x1.5
853009-14	14	1/4
853009-16	16	M16x1.5
853009-17	17	3/8
853009-18	18	M18x1.5
853009-22	22	M22x1.5
853009-21	21	1/2
853009-26	26	M26x1.5

Banjo fitting, bolt, double bolt, copper ring

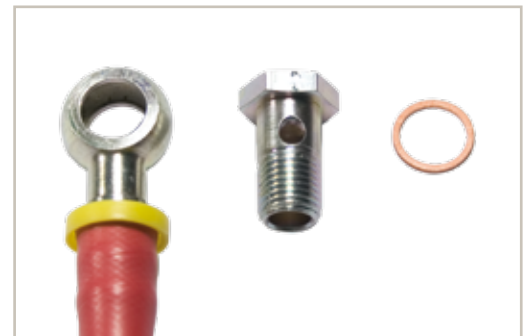

## O-Rings

Fittings are supplied with O-rings made from ozone-resistant Nitrile (NBR) rubber compound suitable for temperatures

from -40 °C up to +120 °C

On request:



Viton® (FPM) compound

from -25 °C up to +200 °C



Ethylene-Propylene (EPDM) compound

from -55 °C up to +150 °C

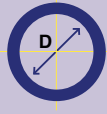

### 711509 – O-rings for SAE fittings (05 end configuration)

Part Number				
	mm	mm	UNF	Size
711509-1	8.92	1.83	7/16x20	-4
711509-2	10.52	1.83	1/2x20	-5
711509-3	11.89	1.98	9/16x18	-6
711509-4	16.36	2.21	3/4x16	-8
711509-5	19.18	2.45	7/8x14	-10
711509-6	23.47	2.95	1-1/16x12	-12
711509-7	29.74	2.95	1-5/16x12	-16
711509-8	37.47	3.00	1-5/8x12	-20

### 2-0 – O-rings for ORFS male (JD and JM end configuration)

Part Number				
	mm	mm	UNF	Size
2-011N552-90	7.65	1.78	9/16x18	-4
2-012N552-90	9.25	1.78	11/16x16	-6
2-014N552-90	12.42	1.78	13/16x16	-8
2-016N552-90	15.60	1.78	1x14	-10
2-018N552-90	18.77	1.78	1-3/16x12	-12
2-021N552-90	23.52	1.78	1-7/16x12	-16
2-025N552-90	29.87	1.78	1-11/16x12	-20
2-029N552-90	37.82	1.78	2x12	-24

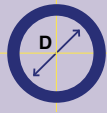

### EARG/VURG/VERG – O-rings for BSP fittings

Part Number				
	mm	mm	BSP	Size
EARG-4	6.0	1.0	1/4x19	-4
C9RG-10	8.5	1.5	3/8x19	-6
VURG-4	12.0	1.5	1/2x14	-8
EARG-10	13.1	1.6	5/8x14	-10
VERG-14	17.0	1.5	3/4x14	-12
VERG-19	21.0	1.5	1x11	-16
EARG-20	29.5	1.5	1-1/4x11	-20



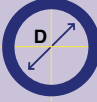

## O-Rings



### 2-2 – O-rings for SAE flanges

Part Number				
	mm	mm	Inch	Size
2-210N552-90	18.64	3.53	1/2	-8
2-214N552-90	24.99	3.53	3/4	-12
2-219N552-90	32.92	3.53	1	-16
2-222N552-90	37.69	3.53	1-1/4	-20
2-225N552-90	47.22	3.53	1-1/2	-24
2-228N552-90	56.74	3.53	2	-32
2-232N552-90	69.44	3.53	2-1/2	-40

### CARG – O-rings for metric 24° female swivel hose-end fittings

Part Number					Tube O.D. mm
	mm	mm	light series metric	heavy series metric	
CARG-6	4.5	1.5	M12x1.5	M14x1.5	6
C9RG-8	6.5	1.5	M14x1.5	M16x1.5	8
C9RG-10	8.5	1.5	M16x1.5	M18x1.5	10
C9RG-12	10.5	1.5	M18x1.5	M20x1.5	12
C9RG-14	12.0	2.0		M22x1.5	14
CARG-15	12.5	2.0	M22x1.5		15
C9RG-16	14.0	2.0		M24x1.5	16
CARG-18	16.0	2.0	M26x1.5		18
C9RG-20	17.0	2.5		M30x2	20
CARG-22	20.0	2.0	M30x2		22
C9RG-25	22.0	2.5		M36x2	25
CARG-28	26.0	2.0	M36x2		28
C9RG-30	27.0	2.5		M42x2	30
CARG-35	32.0	2.5	M45x2		35
C9RG-38	35.0	2.5		M52x2	38
CARG-42	39.0	2.5	M52x2		42

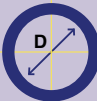
### XARG – Flange “D” rings Caterpillar® style flanges

Part Number				
	mm	mm	Inch	Size
XARG-12	25.4	5.0	3/4	-12
XARG-16	31.9	5.0	1	-16
XARG-20	38.2	5.0	1-1/4	-20
XARG-24	44.7	5.0	1-1/2	-24
XARG-32	63.9	5.0	2	-32

## Worm Drive Hose Clamps

With cross slotted hex head screw (DIN 3017) for all applications

- Bands and housings of AISI 300 series stainless steel
- Unique interlock construction locks directly into band which tightens under tension
- Shouldered hex head, slotted screw  
No spot welds to rupture under stress or corrode
- Rounded band edges
- High efficiency giving high pressure sealing
- Wide clamping range, giving more flexibility to the user



### Miniature Worm Drive Hose Clamps

These small, tough, precision-engineered hose clamps provide:

- Low profile
- Narrow housing
- No protrusions
- Highest sealing
- High working pressure at low torque
- Easy to install in confined areas

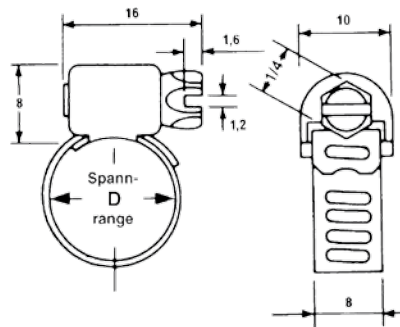

Band width 5/16" - 8 mm

### Miniature Stainless "M" Series

For all clamping applications meeting normal environmental conditions. Hex head screw made of zinc plated carbon steel.

### Miniature Stainless "MS-N" Series

Preferred for those environmental conditions which require the extra protection provided by this 100% stainless steel hose clamp. Hex head screw of AISI 305 series made of stainless steel.

"M" series Part Number	D Stretch area		"MS" series Part Number
	mm	Inch	
M 0200	6 - 16	0.25 - 0.62	MS 0200 N
M 0300	8 - 22	0.30 - 0.87	MS 0300 N
M 0400	16 - 32	0.66 - 1.25	MS 0400 N
M 0500	16 - 38	0.66 - 1.50	MS 0500 N
M 0600	19 - 45	0.66 - 1.75	MS 0600 N
M 0700	25 - 50	1.00 - 2.00	MS 0700 N
M 0800	35 - 60	1.38 - 2.38	MS 0800 N
M 0900	45 - 70	1.75 - 2.75	MS 0900 N
M 1000	58 - 82	2.25 - 3.25	MS 1000 N
M 1100	64 - 90	2.50 - 3.50	MS 1100 N
M 1200	77 - 100	3.00 - 4.00	MS 1200 N

#### For your safety

Hose clamps are intended to ensure the sealing of flexible hoses carrying fluids under pressure; we therefore recommend that you choose the appropriate hose clamp, adhere to the assembly torques indicated and correctly position the hose clamp onto the fitting. Any deformation of the hose requires tightening of the clamp. We disclaim all responsibility for any product failure that might ensue should these recommendations be ignored.

# Worm Drive Hose Clamps

With cross slotted hex head screw (DIN 3017) for all applications

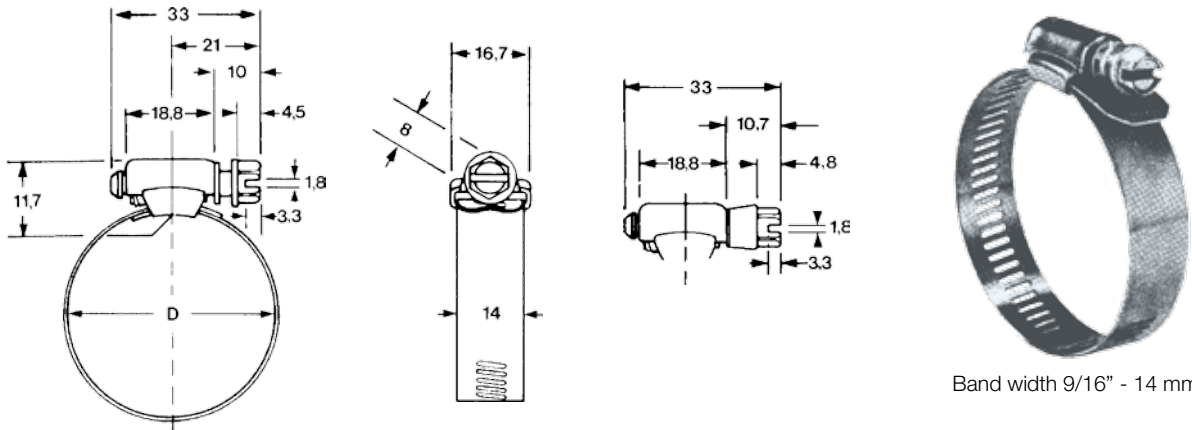

Band width 9/16" - 14 mm

## Standard "S" Series

Band and housing of stainless steel for all clamping applications, meeting normal environmental conditions. Hex head screw made of zinc plated carbon steel.

## Stainless "SS-N" Series

Preferred for those environmental conditions which require the extra protection provided by this 100% stainless steel hose clamp. Hex head screw of AISI 305 series made of stainless steel.

"S" series Part Number	D Stretch area		"SS" series Part Number
	mm	Inch	
S 0600	10 - 22	0.38 - 0.87	SS 0600 N
S 0800	11 - 25	0.44 - 1.00	SS 0800 N
S 1000	13 - 28	0.50 - 1.12	SS 1000 N
S 1040	102 - 178	5.00 - 7.00	SS 1040 N
S 1200	13 - 32	0.50 - 1.25	SS 1200 N
S 1600	19 - 40	0.75 - 1.50	SS 1600 N
S 2000	19 - 44	0.75 - 1.75	SS 2000 N
S 2400	26 - 50	1.00 - 2.00	SS 2400 N
S 2800	34 - 57	1.32 - 2.25	SS 2800 N
S 3200	40 - 64	1.57 - 2.50	SS 3200 N
S 3600	23 - 70	0.88 - 2.75	SS 3600 N
S 4000	29 - 76	1.13 - 3.00	SS 4000 N
S 4400	34 - 82	1.32 - 3.25	SS 4400 N
S 4800	42 - 90	1.63 - 3.50	SS 4800 N
S 5200	48 - 95	1.88 - 3.75	SS 5200 N
S 5600	54 - 100	2.13 - 4.00	SS 5600 N
S 6400	67 - 114	2.63 - 4.50	SS 6400 N
S 7200	80 - 130	3.13 - 5.00	SS 7200 N
S 8000	92 - 140	3.63 - 5.50	SS 8000 N
S 8800	108 - 150	4.25 - 6.00	SS 8800 N
S 9600	121 - 165	4.75 - 6.50	SS 9600 N

### Numerous applications in all fields

Automobile industry, ship building, automation systems, agricultural machinery, packaging machines, machine tools, mechanical handling equipment, welding equipment, construction equipment, petrochemical industry, mining, metallurgy.

## Protected hose assemblies live longer

In places where the hose assembly is exposed to severe mechanical strain, additional hose protectors such as guards, sleeves etc. have proven to be a good solution. The spring guards or armor guards, for example, prevent kinking of the hose and are the ideal protection against extreme abrasion or possible damage from the outside. Before the fitting is crimped to the hose, the guard needs to be pushed onto the hose – so please remember to order the guards together with your order of hose assembly components.

For some applications it is an advantage to bundle hose assemblies with plastic hose protector coils or sleeves so that they make compact units. For this purpose we recommend using PolyGuard protectors, ParKoil hose protectors and Partek Wraps. Partek Wraps hose sleeves are designed for bundling hose assemblies after installation.

Parker offers a broad range of accessories to work smarter, faster and better



### Spring Guard & Armour Guard (SG & AG)

Parker spring guard and armour guard are two products that prolong the life of your hose lines that are exposed to rugged operating conditions. They distribute bending radii to avoid kinking in hose lines and protect hose from abrasion and deep cuts. Guards are constructed of steel wire and plated to resist rust. See page **Eb-9** and **Eb-10**



### PolyGuard & Parkoil (HG & PG)

Protect and bundle your hoses with these spiral guards that minimize kinking and cannot rust. Both the PolyGuard and Parkoil install without removing the hose. See page **Eb-14** and **Eb-15**



### Partek (AS & PS)

Nylon woven protective sleeving gives you tough hose abrasion resistance with two versions of coverage – standard “AS” and a lighter “PS” – both providing protection and bundling capability. See page **Eb-11** and **Eb-12**



### Firesleeve (FS-F)

A flame-resistant sheath that protects your hose from extremely high temperature conditions. See page **Eb-13**



### Partek Wrap (PS-BV)

The need for a protective hose sleeve is not always considered while designing for a hose's application. Many hose assembly installations would benefit from a sleeve, but it is not obvious until all the other hoses and components are in place. Partek Wrap enables the hose sleeve to be installed after the hose assemblies have been positioned and secured in place. The Partek Wrap can be used as extra abrasion protection or to wrap multiple hoses or cables together. See page **Eb-16**

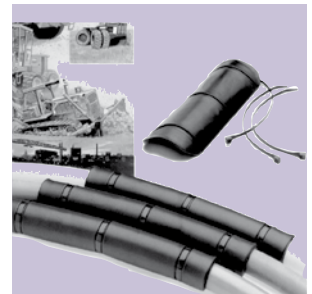

### Hose Shields (HP-B)

Hose protection shields extend hose life by protecting the hose from abrasion that occurs when hose rubs against other hose, metal or concrete. Parker hose shields are resistant to oil, lubricants, gasoline, most solvents and can withstand ambient temperatures from -40 °C to +150 °C. Easily installed and secured by cable ties without disconnecting any hose lines. See page **Eb-17**

## SG – Spring Guard

- Spring Guards protect the hose cover against abrasion and are constructed of steel wire and plated to resist rust.



Hose I.D. Part Number	SG-060	SG-066	SG-072	SG-084	SG-097	SG-106	SG-113	SG-122	SG-131	SG-155	SG-166	SG-182	SG-209	SG-220	SG-232	SG-270	SG-292	SG-369
201, 206, 221FR, 225, 235	-4	-5	-6	-8	-10		-12		-16	-20		-24			-32		-40	-48
213, 285, 293	-4/-5	-6		-8	-10	-12			-16	-20		-24		-32			-40	-48
301SN, 301TC, 302, 304		-4	-5	-6	-8	-10		-12		-16			-20		-24		-32	
351TC, 402, 421RH, 421SN, 422, 424, 426, 436, 441, 441RH, 451TC, 451, 461LT, 462, 463, 471TC, 472TC, 492, 493, 611, 611HT, 681, 681DB, 692	-4	-5	-6	-8	-10		-12			-16		-20	-24			-32		
372, 372RH, 371LT, 701					-6	-8		-10	-12	-16			-20		-24			
601	-4		-5	-6	-8				-12	-16		-20						
774, 721TC, 772LT				-6	-8		-10		-12	-16			-20	-24		-32		
731, 781, 782TC, P35, 791TC, 792TC									-12		-16		-20		-24		-32	
801, 804, 821FR, 831, 836, 837BM	-4/-5		-6	-8	-10		-12		-16									
811, 881, H29, H29ST, H29TC, H29RH									-12	-16		-20		-24		-32		-48
H31, H31ST, H31TC			-4		-6	-8		-10	-12		-16							
R35, R35TC									-12		-16	-20			-24		-32	
R42, R42ST, R42TC								-10	-12		-16		-20		-24		-32	
R50TC								-10	-12		-16		-20					
787TC, 797TC			-6	-8		-10		-12		-16		-20						
412	-4/-6																	
477	-4	-5	-6	-8		-10			-12	-16								

# AG – Armour Guard



- For extreme abrasion or possible damage from the outside, the corrosion-protected steel flat coil sleeve is recommended.

Hose \ I.D. Part Number	mm	AG-060	AG-066	AG-072	AG-084	AG-097	AG-106	AG-113	AG-122	AG-131	AG-155	AG-161	AG-166	AG-182	AG-209	AG-220	AG-232	AG-270	AG-292	AG-319
	15.20	16.75	18.25	21.30	24.60	26.90	28.70	30.95	33.25	39.35	40.85	42.15	46.20	53.05	55.85	58.90	68.55	74.20	81.00	
201, 206, 221FR, 225, 235	-4	-5	-6	-8	-10			-12		-16	-20			-24			-32		-40	
213, 285, 293	-4/-5	-6		-8	-10	-12				-16	-20			-24		-32			-40	
301SN, 301TC, 302, 304		-4	-5	-6	-8	-10			-12		-16				-20		-24		-32	
351TC, 402, 421RH, 421SN, 422, 424, 426, 436, 441, 441RH, 451TC, 451, 461LT, 462, 463, 471TC, 472TC, 492, 493, 611, 611HT, 681, 681DB, 692	-4	-5	-6	-8	-10			-12			-16			-20	-24				-32	
372, 372RH, 371LT, 701						-6	-8		-10	-12	-16				-20		-24			
601	-4		-5	-6	-8					-12	-16			-20						
774, 721TC, 772LT				-6	-8			-10		-12	-16				-20	-24			-32	
731, 781, 782TC, P35, 791TC, 792TC										-12			-16		-20		-24		-32	
801, 804, 821FR, 831, 836, 837BM	-4/-5		-6	-8	-10			-12		-16										
811, 881, H29, H29ST, H29TC, H29RH										-12	-16			-20		-24			-32	-40
H31, H31ST, H31TC			-4		-6	-8		-10	-12			-16								
R35, R35TC										-12		-16		-20			-24		-32	
R42, R42ST, R42TC								-10	-12			-16			-20		-24		-32	
R50TC								-10	-12			-16			-20					
787TC, 797TC			-6	-8		-10		-12			-16			-20						
412	-4/-6																			
477	-4	-5	-6	-8		-10				-12	-16									

## AS – Partek® Nylon Protective Sleeve

Parker's Partek Nylon Protective Sleeving gives you tough hose abrasion protection two ways. First, per the ISO 6945 specification, Partek has a unique tubular weave nylon construction, Partek "AS" is strong enough to withstand greater than 200,000 abrasion cycles without wearing through the fabric at any location. In addition, this weave also gives an exceptionally smooth interior wall, allowing rubber hose to move freely inside the sleeve. This provides easy installation and prevents any internal abrasion problems. Partek sleeving is available in either black or yellow and in sizes to fit most hydraulic hose. Partek, the quick and easy solution to hose protection in high-abrasion areas.



Temperature Range ..... -55 °C up to +120 °C

AS-heavy series (black) Part Number	AS-B-11	AS-B-13	AS-B-13	AS-B-15	AS-B-15	AS-B-17	AS-B-19	AS-B-22	AS-B-27	AS-B-33	-	AS-B-37	AS-B-58	
AS-heavy series (yellow) Part Number	AS-Y-11	AS-Y-13	AS-Y-13	AS-Y-15	AS-Y-15	AS-Y-17	AS-Y-19	AS-Y-22	AS-Y-27	AS-Y-33	AS-Y-35	AS-Y-37	-	
Hose	I.D. mm	17.5	21.8	21.8	26.9	26.9	29.4	32.8	34.5	39.6	44.5	53.8	58.7	90.4
201, 206, 221FR, 225, 235		-4	-5	-6	-8		-10	-12	-16		-20	-24		-48
213, 285, 293		-4	-5	-6	-8	-10	-12		-16		-20	-24		-48
301SN, 301TC, 302, 304, 421WC			-4	-5	-6		-8	-12			-16		-20	
351TC, 402, 421RH, 421SN, 422, 424, 426, 436, 441, 441RH, 451, 451TC, 461LT, 462, 462ST, 463, 471TC, 472TC, 492, 492ST, 493, 611, 611HT, 681, 681DB, 692		-4	-5	-6		-8	-10	-12		-16		-20	-24	
372, 372RH, 701, 371LT						-6	-8	-10	-12		-16		-20	
601			-4	-5	-6		-8	-12			-16		-20	
774, 721TC, 772LT						-6	-8	-10	-12		-16		-20	
731, 774, 781, 782TC, P35, 791TC, 792TC									-12		-16		-20	
801, 804, 821FR, 831, 836, 837BM		-4		-6	-8		-10	-12		-16				
811, 881, H29, H29ST, H29ST, H29RH									-12		-16	-20		-40 -48
H31, H31ST, H31TC			-4	-4	-6	-6	-8	-10	-12		-16			
R35, R35TC										-12	-16	-20		
R42, R42ST, R42TC, R50TC									-10	-12	-16		-20	
787TC, 797TC			-6	-6			-8	-10	-12		-16	-20		
412		-4/-6												
477		-4	-5	-6	-8	-8	-10		-12		-16			

## PS – Partek® Nylon Protective Sleeve

Parker's Partek Nylon Protective Sleeving gives you tough hose abrasion protection two ways. First, per the ISO 6945 specification, Partek has a unique tubular weave nylon construction, Partek "PS" is strong enough to withstand greater than 50,000 abrasion cycles without wearing through the fabric at any location. In addition, this weave also gives an exceptionally smooth interior wall, allowing rubber hose to move freely inside the sleeve. This provides easy installation and prevents any internal abrasion problems. Partek sleeving is available in either black or yellow and in sizes to fit most hydraulic hose. Partek, the quick and easy solution to hose protection in high-abrasion areas.



Temperature Range ..... -55 °C up to +120 °C

PS-standard series (black)	PS-B-13	PS-B-13	PS-B-15	PS-B-15	PS-B-17	PS-B-22	PS-B-22	PS-B-33	PS-B-33	PS-B-35	PS-B-37	PS-B-39	PS-B-45	PS-B-47
Part Number														
I.D. mm	21.3	21.3	25.4	25.4	29.4	34.5	34.5	44.5	44.5	53.8	58.7	65.0	71.4	77.7
<b>Hose</b>														
201, 206, 221FR, 225, 235	-5	-6	-8		-10	-12	-16		-20	-24		-32		-40
213, 285, 293	-5	-6	-8	-10	-12		-16		-20	-24		-32		-40
301SN, 301TC, 302, 304, 421WC	-4	-5	-6		-8	-12			-16		-20	-24	-32	
351TC, 402, 421RH, 421SN, 422, 424, 426, 436, 441, 441RH, 451, 451TC, 461LT, 462, 462ST, 463, 471TC, 472TC, 492, 492ST, 493, 611, 611HT, 681, 681DB, 692	-5	-6		-8	-10	-12		-16		-20	-24		-32	
372, 372RH, 701, 371LT				-6	-8	-10	-12		-16		-20	-24		-32
601	-4	-5	-6		-8	-12			-16		-20	-24	-32	
774, 721TC, 772LT				-6	-8	-10	-12		-16		-20	-24		-32
731, 774, 781, 782TC, P35, 791TC, 792TC							-12		-16		-20	-24		-32
801, 804, 821FR, 831, 836, 837BM		-6	-8		-10	-12		-16						
811, 881, H29, H29ST, H29ST, H29RH							-12		-16	-20		-24	-32	
H31, H31ST, H31TC	-4	-4	-6	-6	-8		-12		-16					
R35, R35TC									-16	-20		-24		-32
R42, R42ST, R42TC							-10	-12	-16		-20	-24		-32
R50TC							-10	-12	-16		-20			
787TC, 797TC	-6	-6			-8		-12		-16	-20				
412														
477	-5	-6	-8	-8	-10		-12		-16					



# FS-F – Fire Sleeves

- Parker Firesleeve is a flame resistant sheath that protects the hose from extreme temperature conditions. Firesleeve easily slides over hoses and readily expands over fitting. When fitting the fire sleeve to hose assemblies with reusable or crimped fittings, a fire sleeve clamp must be used.



- Certification:
  - NF F16-101 (10/88) Classification F1/I2
  - NF F16-102 (04/92) Classification F1/I2
  - STM-S-001 (c) (10/2006)

Temperature Range ..... -73 °C up to +260 °C

Part Number	FS-F-10	FS-F-11	FS-F-12	FS-F-14	FS-F-16	FS-F-18	FS-F-20	FS-F-22	FS-F-24	FS-F-28	FS-F-32	FS-F-38	FS-F-40	FS-F-48	FS-F-60
I.D. mm	14.7	16.5	18.0	21.3	24.4	27.4	30.7	34.0	37.1	43.4	49.8	59.4	62.5	75.2	94.2
<b>Hose</b>															
201, 206, 221FR, 225, 235	-4	-5		-6 -8		-10	-12	-16		-20	-24	-32		-40	-48
213, 285, 293	-4	-5	-6	-8	-10	-12		-16		-20	-24	-32		-40	
301SN, 301TC, 302, 304, 421WC		-4	-5	-6		-8 -10	-12			-16		-20 -24		-32	
351TC, 402, 421RH, 421SN, 422, 424, 426, 436, 441, 441RH, 451, 451TC, 461LT, 462, 462ST, 463, 471TC, 472TC, 492, 492ST, 493, 611, 611HT, 681, 681DB, 692	-3 -4	-5		-6	-8	-10	-12	-14	-16		-20	-24		-32	
601		-4		-5 -6		-8	-10	-12		-16	-20				
372, 372RH, 371LT, 701, 774, 721TC, 772LT					-6	-8	-10	-12		-16		-20 -24		-32	
731, 781, 782TC, P35, 791TC, 792TC							-8	-12		-16		-20	-24	-32	
801, 804, 821FR, 831, 836, 837BM	-4		-6	-8		-10	-12	-16							
811, 881, H29, H29ST, H29TC, H29RH								-12		-16	-20	-24		-32	-40 -48
H31, H31ST, H31TC				-4	-6	-8	-10	-12		-16	-20	-24			
R35, R35TC								-12		-16	-20	-24		-32	
R42, R42ST, R42TC							-10	-12		-16		-20 -24		-32	
R50TC							-10	-12		-16		-20			
787TC, 797TC			-6		-8	-10			-16		-20				
412	-4	-6													
477	-4	-5		-6	-8	-10		-12	-16						

## HG – PolyGuard Hose Protector

Heavy duty polyethylene provides protection in rugged operating conditions  
Great for bundling high-pressure hose lines

- Shields hose from abrasion and cuts
- Easy to install without removing hose lines: no clamps needed
- Minimises risk of kinking
- Resistant to air, water, oil, gasoline, hydraulic fluid and most solvents
- Ideal for bundling plastic tubing or hose lines
- Cannot rust or corrode
- Color: black



**Caution: This material will support combustion**

Temperature Range ..... -17 °C up to +93 °C

Part Number	HG-075	HG-100	HG-125	HG-150	HG-200	HG-350
Hose I.D. mm	19.05	25.40	31.75	38.10	50.80	88.90
201, 206, 213, 221FR, 225, 235, 285, 293	-8/-10	-12	-16	-20/-24	-32/-40	-48
301SN, 301TC, 302, 304	-6/-8	-10/-12		-16/-20	-24/-32	
351TC, 402, 421RH, 421SN, 421WC, 422, 424, 426, 436, 441, 441RH, 451, 451TC, 461LT, 462ST, 462, 463, 471TC, 472TC, 492, 492ST, 493, 611, 611HT, 681, 681DB, 692	-8/-10	-12	-16	-20	-24/-32	
601	-6/-8	-10	-12	-16/-20		
372, 372RH, 371LT, 701, 731, 774, 721TC, 772LT, 781, 782TC, P35, 791TC, 792TC	-6	-8/-10	-12	-16	-20/-24/-32	
731			-12	-16/-20	-24/-32	
477, 801, 804, 821FR, 831, 836, 837BM	-8/-10	-12	-16			
811, 881, H29, H29ST, H29TC, H29RH		-12		-16/-20	-24/-32/-40	-48
R42, R42ST, R42TC	-4/-6/-8	-10/-12	-16	-20	-24	
R50TC		-10/-12	-16	-20		
H31, H31ST, H31TC	-4/-6/-8	-10/-12	-16			
R35, R35TC		-12	-16	-20	-24/-32	
787TC, 797TC		-12	-16		-20	

## PG – ParKoil Hose Protector

Lower-cost protection for applications that call for a tighter bend radius and are less demanding

- Shields hose from abrasion and cuts
- Easy to install without removing hose lines: no clamps needed
- Minimises risk of kinking
- Resistant to air, water, oil, gasoline, hydraulic fluid and most solvents
- Ideal for bundling plastic tubing or hose lines
- Cannot rust or corrode
- Color: black



**Caution: This material will support combustion**  
 Temperature Range ..... -17 °C up to +93 °C

Part Number	PG-038	PG-050	PG-062	PG-075	PG-088	PG-100	PG-119	PG-138	PG-188
Hose I.D. mm	9.65	12.70	15.75	19.05	22.35	25.40	30.25	35.05	47.75
Width of spires	6.35	9.65	9.65	9.65	9.65	15.75	15.75	15.75	15.75
201, 206, 221FR, 225, 235		-4 -5	-6	-8	-10	-12	-16	-20 -24	-32 -40 -48
213, 285, 293	-4	-5	-6 -8	-10	-12		-16	-20 -24	-32 -40 -48
301SN, 301TC, 302, 304		-3 -4	-5	-6	-8	-10 -12		-16	-20 -24 -32
351TC, 402, 421RH, 421SN, 421WC, 422, 424, 426, 436, 441, 441RH, 451, 451TC, 461LT, 462ST, 462, 463, 471TC, 472TC, 492, 492ST, 493, 611, 611HT, 681, 681DB, 692		-4 -5	-6	-8	-10	-12		-16 -20	-24 -32
601		-4		-6	-8	-10	-12	-16	
372, 372RH, 371LT, 701, 731, 774, 721TC, 772LT				-6	-8	-10	-12	-16 -20	-24 -32
H31, H31ST, H31TC				-6	-8	-10	-12	-16	
781, 782TC, P35, 791TC, 792TC, R42, R42ST, R42TC				-4	-6	-8 -10	-12	-16	-20 -24 -32
801, 804, 821FR, 831, 836, 837BM, 477		-4 -5	-6	-8	-10	-12	-16		
811, 881, H29, H29ST, H29TC, H29RH, R35, R35TC							-12	-16 -20	-24 -32
R50C						-10	-12	-16	-20
787TC, 797TC			-6	-8	-10	-12	-16	-20	
412	-4	-6							

## PS – Partek Wrap

Nylon hose sleeve designed for bundling hose assemblies after installation

- Post-assembly installation
- Light weight and high flexibility
- Urethane-coated 1050 ballistic Nylon
- Ambient temperature range of -51 °C to 93 °C
- Fast and easy installation
- Designed for added abrasion resistance or bundling of multiple hoses
- Can be cut to size with household scissors



Part Number	Hose Bundle O.D.		Circumference	Roll Length	Color
	Inch	mm	mm	m	
PS-BV-300	3	76.2	238.8	15.24	black
PS-BV-400	4	101.6	317.5	15.24	black
PS-BV-500	5	127.0	400.0	15.24	black
PS-BV-700	7	177.8	558.8	15.24	black

## WKS – Rubber Hand Grip

For *No-Skive* high pressure water cleaning hoses

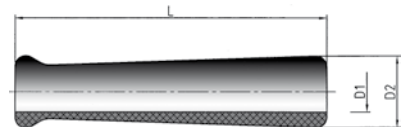

Part Number	Colour	 Hose I.D.				L mm	D1 mm	D2 mm
		DN	Inch	Size	mm			
WKS-4-BLK	black	6	1/4	-4	6.3	120	15.0	24
WKS-4-BLU	blue	6	1/4	-4	6.3	120	15.0	24
WKS-5-BLK	black	8	5/16	-5	7.9	150	17.0	34
WKS-5-BLU	blue	8	5/16	-5	7.9	150	17.0	34
WKS-6-BLK	black	10	3/8	-6	9.5	150	19.5	34
WKS-6-BLU	blue	10	3/8	-6	9.5	150	19.5	34
WKS-8-BLK	black	12	1/2	-8	12.7	150	22.5	34
WKS-8-BLU	blue	12	1/2	-8	12.7	150	22.5	34
WKS-8-GRA	grey	12	1/2	-8	12.7	150	22.5	34

## HP-B – Hose Shield

Hose protection shields extend hose life by protecting the hose from abrasion that occurs when hose rubs against other hose, metal or concrete. Parker hose shields are resistant to oil, lubricants, gasoline, most solvents and can withstand ambient temperatures from -40 °C to +150 °C. Easily installed and secured by cable ties without disconnecting any hose lines.

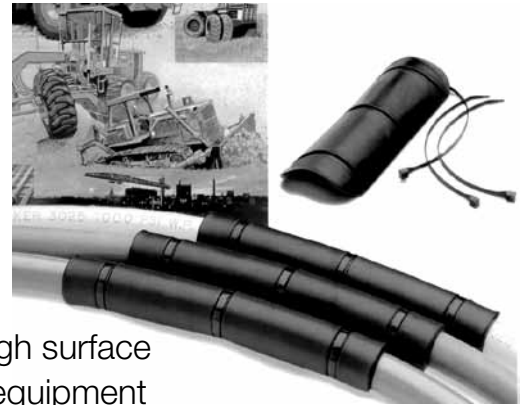

- Use with hose from size -4 up to size -32
- Eliminate hose abrasion on concrete, metal or any rough surface
- Guard against hose deterioration on mobile hydraulic equipment
- Let Parker fill all your hydraulic and pneumatic hose product needs

<b>Hose Shields KIT HP-B-13X18-KIT</b> with – 2 x HP-13 RFL Hose Protectors, length 101 mm (4") – 2 x HP-15 RFL Hose Protectors, length 152 mm (6") – 4 x HP-18 RFL Hose Protectors, length 203 mm (8") – 30 x HT-12 Tie Wraps – 30 x HT-16 Tie Wraps – 15 x HT-22 Tie Wraps	<b>Part Number</b>	<b>HP-B-13X18-KIT</b>
<b>Counter Display HP-B-13-RFL</b> with – 10 x HP-B-13 Hose Protectors, length 101 mm (4") – 30 x HT-12 Tie Wraps	<b>Part Number</b>	<b>HP-B-13-RFL</b>
<b>Counter Display HP-B-15-RFL</b> with – 10 x HP-B-15 Hose Protectors, length 152 mm (6") – 30 x HT-16 Tie Wraps	<b>Part Number</b>	<b>HP-B-15-RFL</b>
<b>Counter Display HP-B-18-RFL</b> with – 5 x HP-B-18 Hose Protectors, length 203 mm (8") – 15 x HT-18 Tie Wraps	<b>Part Number</b>	<b>HP-B-18-RFL</b>
<b>Hose Protector</b> , length 101 mm (4")	<b>Part Number</b>	<b>HP-B-13</b>
<b>Hose Protector</b> , length 152 mm (6")	<b>Part Number</b>	<b>HP-B-15</b>
<b>Hose Protector</b> , length 203 mm (8")	<b>Part Number</b>	<b>HP-B-18</b>

# Hose Whip Restraint

Safety Restraining System for Pressure Hoses

- Prevents whipping of a pressurized hose in the event of the hose separating from its fitting
- The system consists of two parts – a hose collar and a cable assembly



Part Number	A		B	
	Inch	mm	Inch	mm
WRC1212	0.47	12	0.492	12.5
WRC1313	0.51	13	0.531	13.5
WRC1415	0.55	14	0.591	15
WRC1718	0.67	17	0.709	18
WRC1819	0.71	18	0.748	19
WRC2021	0.79	20	0.827	21
WRC2223	0.87	22	0.906	23
WRC2425	0.95	24	0.984	25
WRC2526	0.98	25	1.024	26
WRC2728	1.06	27	1.102	28
WRC2829	1.10	28	1.142	29
WRC3031	1.18	30	1.220	31
WRC3435	1.34	34	1.378	35
WRC3637	1.42	36	1.457	37
WRC3839	1.50	38	1.535	39
WRC4445	1.73	44	1.772	45
WRC4547	1.77	45	1.850	47
WRC4850	1.89	48	1.969	50
WRC5153	2.01	51	2.087	53
WRC5456	2.13	54	2.205	56
WRC6365	2.48	63	2.559	65
WRC6971	2.72	69	2.795	71

## Hose collars

for Hose Whip Restraint System

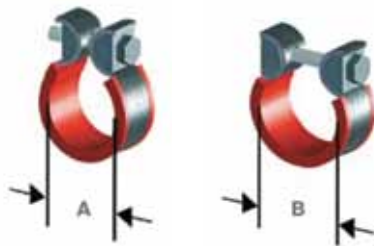

## Cable Assemblies

for hoses attached with port adapters



## Cable Assemblies

for hoses using flange-style connections  
(code 61 and code 62 flanges)

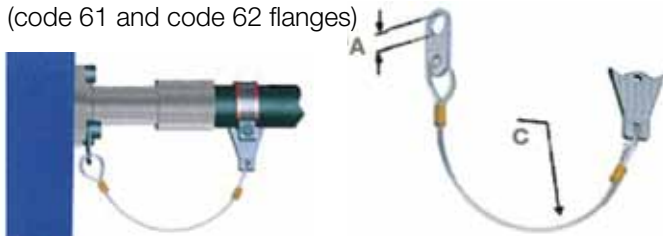



Part Number	A		C	
	Inch	mm	Inch	mm
WRF085	0.33	8.5	17.72	450
WRF105	0.41	10.5	17.72	450
WRF125	0.49	12.5	17.72	450
WRF145	0.57	14.5	17.72	450
WRF165	0.65	16.5	17.72	450
WRF205	0.81	20.5	17.72	450

Part Number	A		C	
	Inch	mm	Inch	mm
WRA145	0.57	14.5	11.81	300
WRA170	0.67	17.0	11.81	300
WRA185	0.73	18.5	11.81	300
WRA205	0.81	20.5	11.81	300
WRA225	0.89	22.5	11.81	300
WRA245	0.96	24.5	11.81	300
WRA265	1.04	26.5	11.81	300
WRA305	1.20	30.5	11.81	300
WRA340	1.34	34.0	17.72	450
WRA365	1.44	36.5	17.72	450
WRA425	1.67	42.5	17.72	450
WRA455	1.79	45.5	17.72	450
WRA490	1.93	49.0	17.72	450
WRA525	2.07	52.5	17.72	450
WRA600	2.36	60.0	17.72	450

## HS – Containment Grips

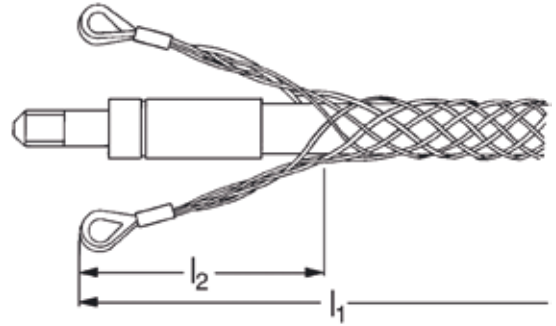
- Material: electrogalvanized steel wire



Part Number	Hose I.D.				Ø mm	Working load kN	Breaking load kN	Total length l1 mm	Length of loops l2 mm
									
	DN	Inch	Size	mm					
HS-03	5	3/16	-3	4.8	9 - 15	3	9	600	200
HS-05	8	5/16	-5	7.9	12 - 20	6	18	600	200
HS-08	12	1/2	-8	12.7	20 - 30	11	33	600	200
HS-12	20	3/4	-12	19.0	30 - 40	11	33	600	200
HS-16	25	1	-16	25.4	40 - 50	16	48	600	200

## Thread Identification Kit

The thread identification tools are useful to help you identify international threads such as:

- European threads  
(Metric, BSPP, BSPT threads) and
- U.S. threads  
(NPT and SAE straight threads UNF)

### Technical / Order Data

**Thread identification kit**  
with thread gauges, a set of callipers,  
thread profiles and instruction booklet



<b>Part Number</b>	English	<b>H905375-GB</b>
<b>Part Number</b>	German	<b>H905375-DE</b>
<b>Part Number</b>	French	<b>H905375-FR</b>

The components of the thread ID Kit are not high-precision gauges but simple instruments for workshop use.

## Parker „Hoze-Oil“

Parker's hose assembly lubricant is pressure and temperature resistant. Simply dip the hose ends into Parker hoze-oil and slightly lubricate the tooling prior to crimping

Volume	1 l
Part Number	Hoze-Oil



## OilOn TH 11-3

Oiling pad for lubrication of fittings

The perfect way to lubricate the fitting, making it easier to insert into the hose. A foam rubber sponge that evenly disperses the oil onto the fitting, in an effective and easy manner.

Material	steel/plastic
Dimensions	L 130 x W 130 x H 70 mm
Part Number	TH11-3

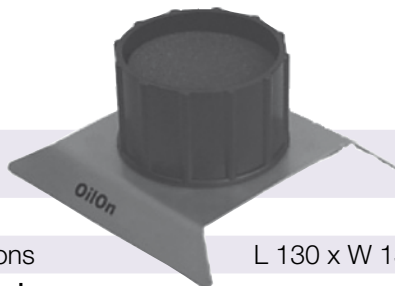

## Push-Lok® Assembly Oil H896137

Water-oil emulsion for easier assembly of Parker Push-Lok® fittings. This product is very useful in combination with 830M, 837BM and 837PU hoses as the Push-Lok® assembly oil is free from wetting disturbing substances, e.g. silicone (Labs-free).

Volume	1 l
Part Number	H896137



## Push-Lok® Assembly Tool

Tool designed for assembly of Push-Lok® fittings and hoses in all sizes. Toggle actions greatly reduce effort necessary to hold hose and press in fitting. Only a few pounds of force is needed on either handle to quickly assemble any size.

Assembly Tool 611050G

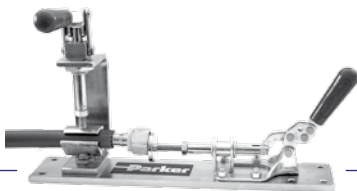

Overall length	320 mm
Weight	2.2 kg
Part Number	611050G

Assembly Tool 611050HV  
"Rigid version"

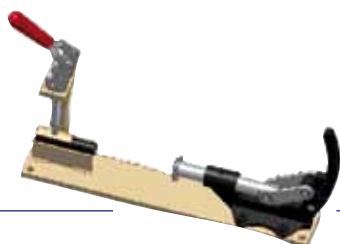

Dimensions	L 500 x W 90 x H 300 mm
Weight	7.5 kg
Part Number	611050HV



# KarryKrimp® 1 (Parkrimp® 1) / KarryKrimp® 2 (PHastkrimp®)

KarryKrimp 1 crimps Parkrimp® fittings 26, 43, 46, 48 series size -4 up to -20

KarryKrimp 2 crimps Parkrimp® fittings 26, 43, 46, 48, 70, 71, 73, 77 and 78 series

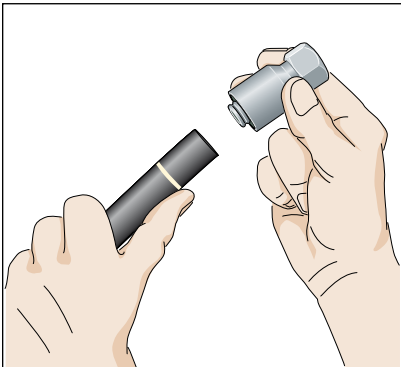

1. Push the hose all the way into the coupling. Place the hose next to the fitting shell and mark the length of the shell onto the hose – (lubricate hose end if necessary) push hose into the fitting until the mark on the hose is even with the end of the shell.

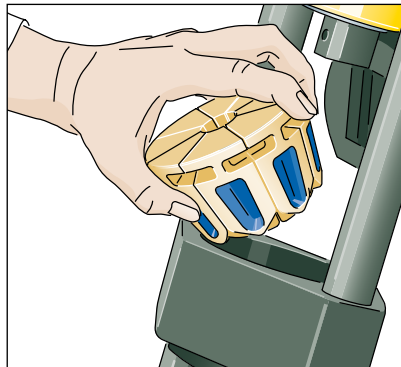

2. Pull pin and drop hinged die-train in place. Pay attention to die segment location.

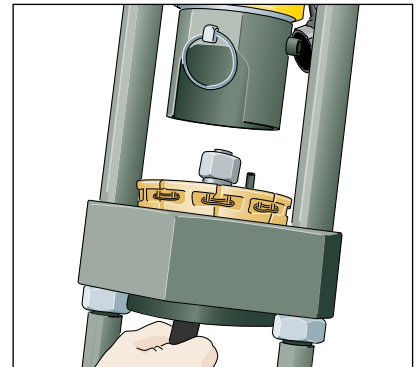

3. Insert fitting into the dies. Release, fitting will self position.



3. (a) Position the fitting on the die step.

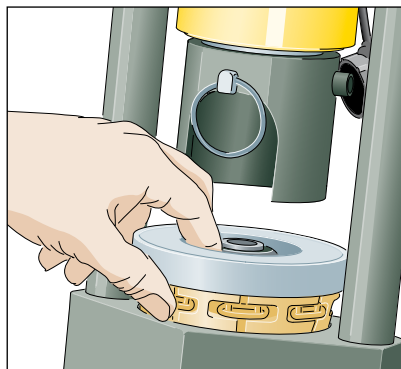

4. Place die ring on top of the dies.

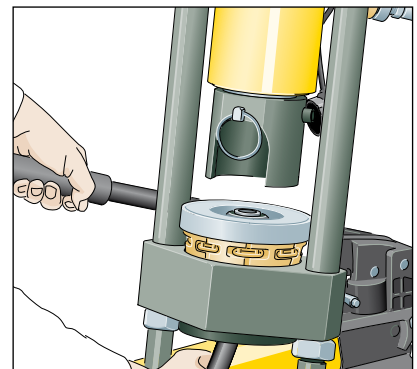

5. Position cylinder and replace pin. Pump until die ring contacts base plate.

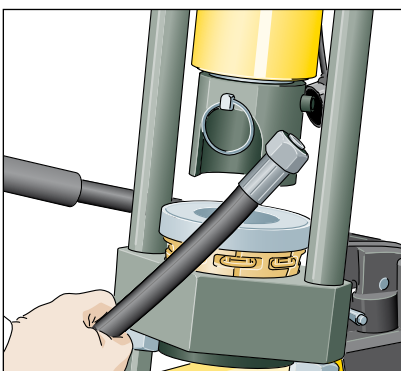

6. Release pressure – remove finished assembly.

# Parkrimp® 2 – 83CE

Parkrimp® fittings 26, 43, 46, 48, 70, 71, 73, 76, 77, 78, 79 and S6 series size -4 up to -32

For one-piece die sets 80C- ... and 83C- ... size -4 to -16



With the pusher in the full up position, lift the back half of the split die ring. Lock it in the up position by pushing the slide pin in (the slide pin is located inside the pusher at the back).

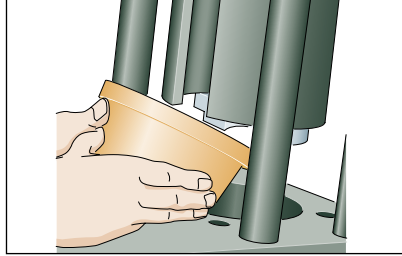

Carefully insert the adapter bowl into the base bowl. The adapter bowl must be tilted toward the back of the crimper during insertion.

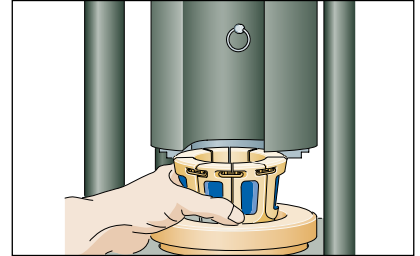

Insert the proper size and series die set into the adapter bowl.  
Note: die sets are colour coded by size and have the fitting series and dash size stamped on the top.  
Pay attention to die segment location.

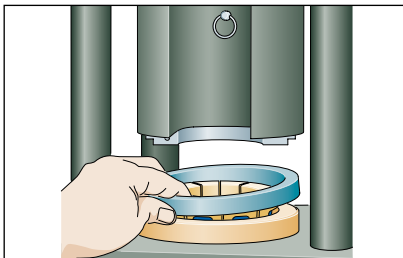

When swaging 43 series fittings on 100R2, 100R3, 100R4 and 100R9 type hose, the black spacer ring must be placed.

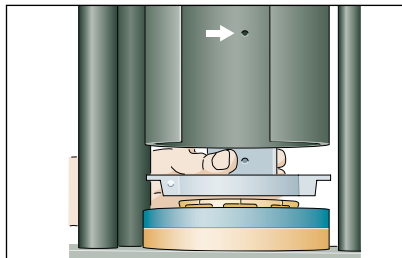

Lower the back half of the split die ring onto the dies by pulling the slide pin forward.

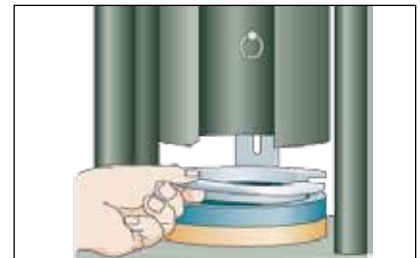

Insert the front half of the split die ring aligning the pin in the half with the hole in the front half.

For two-piece die sets 83C-... size -20 to -32

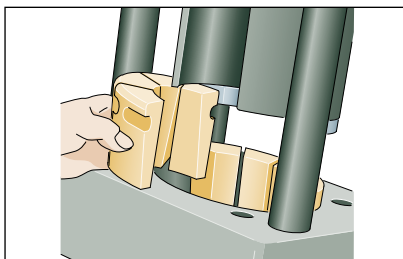

Insert the proper size die set into the die bowl (the die sets are in two halves of four dies each; Place one half in the back and one half in the front to facilitate removal of bent tube fittings).

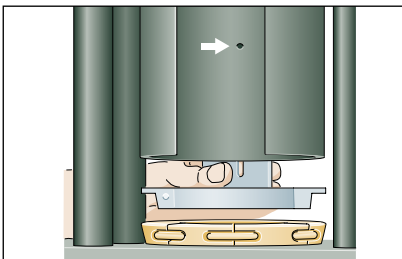

Lower the back half of the split die ring onto the dies by pulling the slide pin forward.

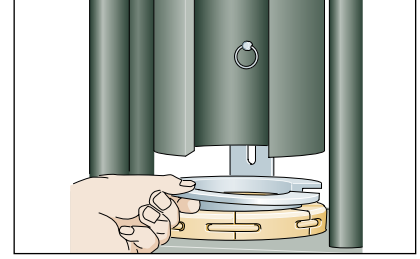

Insert the front half of the split die ring aligning the pin in the half with the hole in the front half.



Parkalign® feature  
Position hose from below in dies.  
Rest bottom of coupling on die step.

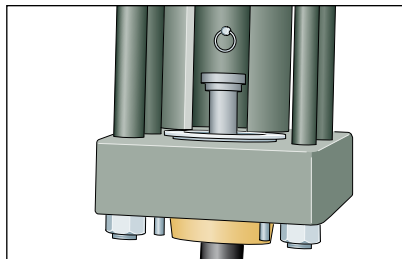

Turn on the pump by pressing the button on the left hand switch box. Lower the pusher by pressing the lower button on the right hand switch box. When the die ring contacts the base plate, the swaging is complete.

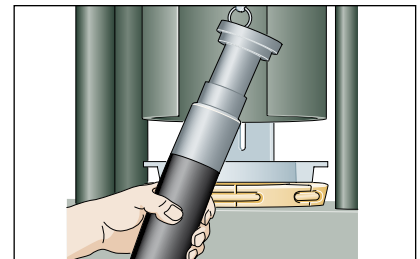

Push the black button at the top of the switch box to open dies and remove the finished assembly.  
You do not have to remove any tooling to remove or insert straight fittings. The front half of the split die ring and the front die train must be removed to insert and remove bent tube fittings.

# KarryKrimp® 1 (Parkrimp® 1)

## 26 Series

Hose I.D.			Hose type	Fitting series	E Insertion length mm	A Length ±0.50 mm	Crimp diameter		Die set	Die ring	
mm	Size	Inch					Ø B ±0.25 mm	Ø C ±0.25 mm		R01 silver	R02 black
5.0	-4	3/16	<b>213-285-293</b>	26	21	12.20	11.95	11.55	<b>80C-E04</b>	X	
5.0	-4	3/16	<b>201-206</b>	26	21	12.20	12.95	12.55	<b>80C-E04</b>		X
6.3	-5	1/4	<b>213</b>	26	21	12.20	13.45	13.10	<b>80C-E05</b>	X	
6.3	-5	1/4	<b>201-206-221FR</b>	26	21	12.20	14.50	14.10	<b>80C-E05</b>		X
8.0	-6	5/16	<b>213-285-293</b>	26	21	12.20	14.85	14.50	<b>80C-E06</b>	X	
8.0	-6	5/16	<b>201-206-221FR</b>	26	21	12.20	15.90	15.50	<b>80C-E06</b>		X
10.0	-8	13/32	<b>213-285-293</b>	26	21	12.20	17.30	16.90	<b>80C-E08</b>	X	
10.0	-8	13/32	<b>201-206-221FR</b>	26	21	12.20	18.30	17.90	<b>80C-E08</b>		X
12.5	-10	1/2	<b>213-285-293</b>	26	22	14.70	20.70	20.30	<b>80C-E10</b>	X	
12.5	-10	1/2	<b>201-206-221FR</b>	26	22	14.70	21.70	21.35	<b>80C-E10</b>		X
16.0	-12	5/8	<b>213-285-293</b>	26	22	14.70	23.50	23.10	<b>80C-E12</b>	X	
16.0	-12	5/8	<b>201-206-221FR</b>	26	22	14.70	24.50	24.15	<b>80C-E12</b>		X
22.0	-16	7/8	<b>213-293</b>	26	25	15.50	30.10	29.70	<b>80C-E16</b>	X	
22.0	-16	7/8	<b>201-206-221FR</b>	26	25	15.50	31.10	30.75	<b>80C-E16</b>		X

KarryKrimp 1 is not suitable for crimping stainless steel fittings.

Dimensions shown may be changed at any time without prior notice. These crimping tables are intended as a guide. Before crimping hoses and fittings it must be ensured that you have the most recent crimping dimensions. Please contact your local Parker sales office or [HPDE\\_Helpdesk@parker.com](mailto:HPDE_Helpdesk@parker.com)  
Crimp Charts Status: 2011-05-17

# KarryKrimp® 1 (Parkrimp® 1)

## 46 Series

Hose I.D.				Hose type	Fitting series	Die set	Die ring		Insert depth	Crimp diameter	
DN	Inch	Size	mm				R01 silver	R02 black		mm	mm
6	1/4	-4	6.3	492-492ST-692	46	80C-B04	X		23	14.35	14.85
6	1/4	-4	6.3	441-441RH-461LT-462-462ST	46	80C-B04		X	23	15.35	15.85
8	5/16	-5	7.9	492-492ST-692	46	80C-B05	X		23	16.15	16.65
8	5/16	-5	7.9	441-441RH-461LT-462-462ST-463	46	80C-B05		X	23	17.15	17.65
10	3/8	-6	9.5	492-492ST-692	46	80C-B06	X		22	19.30	19.80
10	3/8	-6	9.5	441-441RH-461LT-462-462ST-463	46	80C-B06		X	22	20.35	20.85
12	1/2	-8	12.7	492-492ST	46	80C-B08	X		24	22.35	22.85
12	1/2	-8	12.7	441-441RH-461LT-462-462ST-463-692	46	80C-B08		X	24	23.35	23.85
16	5/8	-10	15.9	492-492ST	46	80C-B10	X		25	25.65	26.15
16	5/8	-10	15.9	441-441RH-461LT-462-462ST-692	46	80C-B10		X	25	26.65	27.15
20	3/4	-12	19.1	492-492ST	46	80C-B12	X		25	29.45	29.95
20	3/4	-12	19.1	441-441RH-461LT-462-462ST	46	80C-B12		X	25	30.50	31.00
25	1	-16	25.4	492-492ST	46	80C-B16	X		29	37.10	37.60
25	1	-16	25.4	441-441RH-461LT-462-462ST	46	80C-B16		X	29	38.10	38.60
32	1-1/4	-20	31.8	492-492ST	46	80C-B20	X		35	43.95	44.45
32	1-1/4	-20	31.8	461LT-462-462ST	46	80C-B20		X	35	44.95	45.45

KarryKrimp 1 is not suitable for crimping stainless steel fittings.

Dimensions shown may be changed at any time without prior notice. These crimping tables are intended as a guide. Before crimping hoses and fittings it must be ensured that you have the most recent crimping dimensions. Please contact your local Parker sales office or [HPDE\\_Helpdesk@parker.com](mailto:HPDE_Helpdesk@parker.com)  
Crimp Charts Status: 2011-05-17

# KarryKrimp® 1 (Parkrimp® 1)

## 48 Series

Hose I.D.				Hose type	Fitting series	Die set	Die ring		Insert depth	Crimp diameter	
DN	Inch	Size	mm				R01 silver	R02 black		mm	mm
6	1/4	-4	6.3	421SN-422-441-441RH-451TC-461LT-462-462ST-471TC-472TC-477-493	48	80C-C04	X		22	16.40	16.90
6	1/4	-4	6.3	301SN-302-304-421WC-601	48	80C-C04		X	22	17.40	17.90
8	5/16	-5	7.9	421SN-422-441-441RH-461LT-462-462ST-471TC-472TC-477-493	48	80C-C05	X		24	18.05	18.55
8	5/16	-5	7.9	301SN-302	48	80C-C05		X	24	19.05	19.55
10	3/8	-6	9.5	421SN-422-436-441-441RH-451TC-461LT-462-462ST-471TC-472TC-477-493	48	80C-C06	X		22	20.35	20.85
10	3/8	-6	9.5	301SN-302	48	80C-C06		X	22	21.35	21.85
12	1/2	-8	12.7	421SN-422-426-436-441-441RH-451TC-461LT-462-462ST-471TC-472TC-477-493	48	80C-C08	X		24	23.35	23.85
12	1/2	-8	12.7	301SN-302	48	80C-C08		X	24	24.40	24.90
16	5/8	-10	15.9	421SN-422-426-436-441-441RH-451TC-461LT-462-462ST-471TC-472TC-477	48	80C-C10	X		25	26.65	27.15
16	5/8	-10	15.9	301SN-302	48	80C-C10		X	25	27.70	28.20
20	3/4	-12	19.1	421SN-422-426-436-441-441RH-451TC-461LT-462-462ST-471TC-472TC-477	48	80C-C12	X		25	30.50	31.00
20	3/4	-12	19.1	301SN-302	48	80C-C12		X	25	31.50	32.00
25	1	-16	25.4	421SN-422-426-436-441-441RH-451TC-461LT-462-462ST-471TC-472TC-477	48	80C-C16	X		30	38.10	38.60
25	1	-16	25.4	301SN-302	48	80C-C16		X	30	39.05	39.55
32	1-1/4	-20	31.8	421RH-421SN-422-426-472TC	48	80C-C20	X		46	50.05	50.55
32	1-1/4	-20	31.8	301SN-302-304-811-881	48	80C-C20		X	46	51.05	51.55

KarryKrimp 1 is not suitable for crimping stainless steel fittings.

Dimensions shown may be changed at any time without prior notice. These crimping tables are intended as a guide. Before crimping hoses and fittings it must be ensured that you have the most recent crimping dimensions. Please contact your local Parker sales office or [HPDE\\_Helpdesk@parker.com](mailto:HPDE_Helpdesk@parker.com)  
Crimp Charts Status: 2011-05-17

# KarryKrimp® 2 (PHastkrimp®)

## 26 Series

Hose I.D.			Hose type	Fitting series	E Insertion length mm	A Length ±0.50 mm	Crimp diameter		Die set	Die ring	
mm	Size	Inch					Ø B ±0.25 mm	Ø C ±0.25 mm		R01 silver	R02 black
5.0	-4	3/16	<b>213-285-293</b>	26	21	12.20	11.95	11.55	<b>80C-E04</b>	X	
5.0	-4	3/16	<b>201-206</b>	26	21	12.20	12.95	12.55	<b>80C-E04</b>		X
6.3	-5	1/4	<b>213</b>	26	21	12.20	13.45	13.10	<b>80C-E05</b>	X	
6.3	-5	1/4	<b>201-206-221FR</b>	26	21	12.20	14.50	14.10	<b>80C-E05</b>		X
8.0	-6	5/16	<b>213-285-293</b>	26	21	12.20	14.85	14.50	<b>80C-E06</b>	X	
8.0	-6	5/16	<b>201-206-221FR</b>	26	21	12.20	15.90	15.50	<b>80C-E06</b>		X
10.0	-8	13/32	<b>213-285-293</b>	26	21	12.20	17.30	16.90	<b>80C-E08</b>	X	
10.0	-8	13/32	<b>201-206-221FR</b>	26	21	12.20	18.30	17.90	<b>80C-E08</b>		X
12.5	-10	1/2	<b>213-285-293</b>	26	22	14.70	20.70	20.30	<b>80C-E10</b>	X	
12.5	-10	1/2	<b>201-206-221FR</b>	26	22	14.70	21.70	21.35	<b>80C-E10</b>		X
16.0	-12	5/8	<b>213-285-293</b>	26	22	14.70	23.50	23.10	<b>80C-E12</b>	X	
16.0	-12	5/8	<b>201-206-221FR</b>	26	22	14.70	24.50	24.15	<b>80C-E12</b>		X
22.0	-16	7/8	<b>213-293</b>	26	25	15.50	30.10	29.70	<b>80C-E16</b>	X	
22.0	-16	7/8	<b>201-206-221FR</b>	26	25	15.50	31.10	30.75	<b>80C-E16</b>		X

Dimensions shown may be changed at any time without prior notice. These crimping tables are intended as a guide. Before crimping hoses and fittings it must be ensured that you have the most recent crimping dimensions. Please contact your local Parker sales office or [HPDE\\_Helpdesk@parker.com](mailto:HPDE_Helpdesk@parker.com)  
Crimp Charts Status: 2011-05-17

# KarryKrimp® 2 (PHastkrimp®)

## 46 Series

Hose I.D.				Hose type	Fitting series	Die set	Die ring		Insert depth	Crimp diameter	
DN	Inch	Size	mm				R01 silver	R02 black		mm	mm
6	1/4	-4	6.3	492-492ST-692	46	80C-B04	X		23	14.35	14.85
6	1/4	-4	6.3	441-441RH-461LT-462-462ST	46	80C-B04		X	23	15.35	15.85
8	5/16	-5	7.9	492-492ST-692	46	80C-B05	X		23	16.15	16.65
8	5/16	-5	7.9	441-441RH-461LT-462-462ST-463	46	80C-B05		X	23	17.15	17.65
10	3/8	-6	9.5	492-492ST-692	46	80C-B06	X		22	19.30	19.80
10	3/8	-6	9.5	441-441RH-461LT-462-462ST-463	46	80C-B06		X	22	20.35	20.85
12	1/2	-8	12.7	492-492ST	46	80C-B08	X		24	22.35	22.85
12	1/2	-8	12.7	441-441RH-461LT-462-462ST-463-692	46	80C-B08		X	24	23.35	23.85
16	5/8	-10	15.9	492-492ST	46	80C-B10	X		25	25.65	26.15
16	5/8	-10	15.9	441-441RH-461LT-462-462ST-692	46	80C-B10		X	25	26.65	27.15
20	3/4	-12	19.1	492-492ST	46	80C-B12	X		25	29.45	29.95
20	3/4	-12	19.1	441-441RH-461LT-462-462ST	46	80C-B12		X	25	30.50	31.00
25	1	-16	25.4	492-492ST	46	80C-B16	X		29	37.10	37.60
25	1	-16	25.4	441-441RH-461LT-462-462ST	46	80C-B16		X	29	38.10	38.60
32	1-1/4	-20	31.8	492-492ST	46	80C-B20	X		35	43.95	44.45
32	1-1/4	-20	31.8	461LT-462-462ST	46	80C-B20		X	35	44.95	45.45

Dimensions shown may be changed at any time without prior notice. These crimping tables are intended as a guide. Before crimping hoses and fittings it must be ensured that you have the most recent crimping dimensions. Please contact your local Parker sales office or [HPDE\\_Helpdesk@parker.com](mailto:HPDE_Helpdesk@parker.com)  
Crimp Charts Status: 2011-05-17

# KarryKrimp® 2 (PHastkrimp®)

## 48 Series

Hose I.D.				Hose type	Fitting series	Die set	Die ring		Insert depth	Crimp diameter	
DN	Inch	Size	mm				R01 silver	R02 black		mm	mm
6	1/4	-4	6.3	421SN-422-441-441RH-451TC-461LT-462-462ST-471TC-472TC-477-493	48	80C-C04	X		22	16.40	16.90
6	1/4	-4	6.3	301SN-302-304-421WC-601	48	80C-C04		X	22	17.40	17.90
8	5/16	-5	7.9	421SN-422-441-441RH-461LT-462-462ST-471TC-472TC-477-493	48	80C-C05	X		24	18.05	18.55
8	5/16	-5	7.9	301SN-302	48	80C-C05		X	24	19.05	19.55
10	3/8	-6	9.5	421SN-422-436-441-441RH-451TC-461LT-462-462ST-471TC-472TC-477-493	48	80C-C06	X		22	20.35	20.85
10	3/8	-6	9.5	301SN-302	48	80C-C06		X	22	21.35	21.85
12	1/2	-8	12.7	421SN-422-426-436-441-441RH-451TC-461LT-462-462ST-471TC-472TC-477-493	48	80C-C08	X		24	23.35	23.85
12	1/2	-8	12.7	301SN-302	48	80C-C08		X	24	24.40	24.90
16	5/8	-10	15.9	421SN-422-426-436-441-441RH-451TC-461LT-462-462ST-471TC-472TC-477	48	80C-C10	X		25	26.65	27.15
16	5/8	-10	15.9	301SN-302	48	80C-C10		X	25	27.70	28.20
20	3/4	-12	19.1	421SN-422-426-436-441-441RH-451TC-461LT-462-462ST-471TC-472TC-477	48	80C-C12	X		25	30.50	31.00
20	3/4	-12	19.1	301SN-302	48	80C-C12		X	25	31.50	32.00
25	1	-16	25.4	421SN-422-426-436-441-441RH-451TC-461LT-462-462ST-471TC-472TC-477	48	80C-C16	X		30	38.10	38.60
25	1	-16	25.4	301SN-302	48	80C-C16		X	30	39.05	39.55
32	1-1/4	-20	31.8	421RH-421SN-422-426-472TC	48	80C-C20	X		46	50.05	50.55
32	1-1/4	-20	31.8	301SN-302-304-811-881	48	80C-C20		X	46	51.05	51.55

Dimensions shown may be changed at any time without prior notice. These crimping tables are intended as a guide. Before crimping hoses and fittings it must be ensured that you have the most recent crimping dimensions. Please contact your local Parker sales office or [HPDE\\_Helpdesk@parker.com](mailto:HPDE_Helpdesk@parker.com)  
Crimp Charts Status: 2011-05-17



# KarryKrimp® 2 (PHastkrimp®)

## 70, 71, 73, 77, 78 Series

Hose I.D.				Hose type	Fitting series	Die set	Die ring		Insert depth	Crimp diameter		Stainless steel 1)
DN	Inch	Size	mm				R01 silver	R02 black		mm	mm	
10	3/8	-6	9.5	<b>371LT-372-372RH-372TC-701-701ST</b>	70	<b>83C-D06</b>		X	27	25.15	25.65	•
10	3/8	-6	9.5	<b>721TC</b>	71	<b>83C-D06</b>	X		28	24.15	24.65	•
12	1/2	-8	12.7	<b>371LT-372-372RH-372TC-701-F42</b>	70	<b>83C-D08</b>		X	33	28.95	29.45	•
12	1/2	-8	12.7	<b>721TC</b>	71	<b>83C-D08</b>	X		33	27.95	28.45	•
12	1/2	-8	12.7	<b>787TC-797TC</b>	77	<b>80C-CS08</b>		X	35	23.65	24.15	
16	5/8	-10	15.9	<b>371LT-372-372RH-372TC-701</b>	70	<b>83C-D10</b>		X	35	32.00	32.50	•
16	5/8	-10	15.9	<b>721TC</b>	71	<b>83C-D10</b>	X		36	31.00	31.50	•
16	5/8	-10	15.9	<b>787TC-797TC</b>	77	<b>80C-CS10</b>		X	39	26.85	27.35	
20	3/4	-12	19.1	<b>371LT-372-372RH-372TC-701</b>	70	<b>83C-D12</b>		X	38	35.40	35.90	•
20	3/4	-12	19.1	<b>721TC-774</b>	71	<b>83C-D12</b>	X		37	34.40	34.90	•
20	3/4	-12	19.1	<b>731</b>	73	<b>80C-L12</b>	X		48	36.05	36.55	
20	3/4	-12	19.1	<b>781-782TC</b>	78	<b>80C-L12</b>	X		48	36.05	36.55	•
20	3/4	-12	19.1	<b>787TC-797TC</b>	77	<b>80C-CS12</b>		X	45	31.65	32.15	
25	1	-16	25.4	<b>371LT-372-372RH-372TC-701</b>	70	<b>83C-D16</b>		X	46	44.05	44.55	•
25	1	-16	25.4	<b>721TC-774</b>	71	<b>83C-D16</b>	X		45	43.05	43.55	•
25	1	-16	25.4	<b>731</b>	73	<b>80C-L16</b>	X		51	43.95	44.45	
25	1	-16	25.4	<b>781-782TC</b>	78	<b>80C-L16</b>	X		51	43.95	44.45	•
32	1.1/4	-20	31.8	<b>721TC-774</b>	71	<b>83C-D20</b>	X		46	51.45	51.95	•

1) Crimp diameters for stainless steel fittings can be up to 0.25 mm larger than for standard steel fittings.

Dimensions shown may be changed at any time without prior notice. These crimping tables are intended as a guide. Before crimping hoses and fittings it must be ensured that you have the most recent crimping dimensions. Please contact your local Parker sales office or [HPDE\\_Helpdesk@parker.com](mailto:HPDE_Helpdesk@parker.com)  
Crimp Charts Status: 2011-05-17

# Parkrimp® 2

## 26 Series

Hose I.D.			Hose type	Fitting series	E Insertion length mm	A Length ±0.50 mm	Crimp diameter		Die set	Die ring 83C-R02	Base plate 83C-R02H	Adapter bowl 83C-0CB
mm	Size	Inch					Ø B ±0.25 mm	Ø C ±0.25 mm				
5.0	-4	3/16	<b>213-285-293</b>	26	21	12.20	11.95	11.55	<b>80C-E04</b>			X
5.0	-4	3/16	<b>201-206</b>	26	21	12.20	12.95	12.55	<b>80C-E04</b>	X		X
6.3	-5	1/4	<b>213</b>	26	21	12.20	13.45	13.10	<b>80C-E05</b>			X
6.3	-5	1/4	<b>201-206-221FR</b>	26	21	12.20	14.50	14.10	<b>80C-E05</b>	X		X
8.0	-6	5/16	<b>213-285-293</b>	26	21	12.20	14.85	14.50	<b>80C-E06</b>			X
8.0	-6	5/16	<b>201-206-221FR</b>	26	21	12.20	15.90	15.50	<b>80C-E06</b>	X		X
10.0	-8	13/32	<b>213-285-293</b>	26	21	12.20	17.30	16.90	<b>80C-E08</b>			X
10.0	-8	13/32	<b>201-206-221FR</b>	26	21	12.20	18.30	17.90	<b>80C-E08</b>	X		X
12.5	-10	1/2	<b>213-285-293</b>	26	22	14.70	20.70	20.30	<b>80C-E10</b>			X
12.5	-10	1/2	<b>201-206-221FR</b>	26	22	14.70	21.70	21.35	<b>80C-E10</b>	X		X
16.0	-12	5/8	<b>213-285-293</b>	26	22	14.70	23.50	23.10	<b>80C-E12</b>			X
16.0	-12	5/8	<b>201-206-221FR</b>	26	22	14.70	24.50	24.15	<b>80C-E12</b>	X		X
22.0	-16	7/8	<b>213-293</b>	26	25	15.50	30.10	29.70	<b>80C-E16</b>			X
22.0	-16	7/8	<b>201-206-221FR</b>	26	25	15.50	31.10	30.75	<b>80C-E16</b>	X		X
29.0	-20	1 1/8	<b>213</b>	26	25	16.50	36.30	35.95	<b>83C-E20</b>			
29.0	-20	1 1/8	<b>201-206</b>	26	25	16.50	37.35	36.95	<b>83C-E20</b>		X	
35.0	-24	1 3/8	<b>213</b>	26	27	16.50	42.65	42.30	<b>83C-E24</b>			
35.0	-24	1 3/8	<b>201-206</b>	26	27	16.50	43.70	43.30	<b>83C-E24</b>		X	
46.0	-32	1 13/16	<b>213</b>	26	32	22.90	55.10	54.75	<b>83C-E32</b>			
46.0	-32	1 13/16	<b>201-206</b>	26	32	22.90	56.15	55.75	<b>83C-E32</b>		X	

Dimensions shown may be changed at any time without prior notice. These crimping tables are intended as a guide. Before crimping hoses and fittings it must be ensured that you have the most recent crimping dimensions. Please contact your local Parker sales office or HPDE\_Helpdesk@parker.com  
Crimp Charts Status: 2011-05-17

# Parkrimp® 2

## 46 Series

Hose I.D.				Hose type	Fitting series	Die set	1) 83C-R02	2) 83C-R02H	3) 83C-0CB	Insert depth mm	Crimp diameter	
DN	Inch	Size	mm								mm	mm
6	1/4	-4	6.3	492-492ST-692	46	80C-B04			X	23	14.35	14.85
6	1/4	-4	6.3	441-441RH-461LT-462-462ST	46	80C-B04	X		X	23	15.35	15.85
8	5/16	-5	7.9	492-492ST-692	46	80C-B05			X	23	16.15	16.65
8	5/16	-5	7.9	441-441RH-461LT-462-462ST-463	46	80C-B05	X		X	23	17.15	17.65
10	3/8	-6	9.5	492-492ST-692	46	80C-B06			X	22	19.30	19.80
10	3/8	-6	9.5	441-441RH-461LT-462-462ST-463	46	80C-B06	X		X	22	20.35	20.85
12	1/2	-8	12.7	492-492ST	46	80C-B08			X	24	22.35	22.85
12	1/2	-8	12.7	441-441RH-461LT-462-462ST-463-692	46	80C-B08	X		X	24	23.35	23.85
16	5/8	-10	15.9	492-492ST	46	80C-B10			X	25	25.65	26.15
16	5/8	-10	15.9	441-441RH-461LT-462-462ST-692	46	80C-B10	X		X	25	26.65	27.15
20	3/4	-12	19.1	492-492ST	46	80C-B12			X	25	29.45	29.95
20	3/4	-12	19.1	441-441RH-461LT-462-462ST	46	80C-B12	X		X	25	30.50	31.00
25	1	-16	25.4	492-492ST	46	80C-B16			X	29	37.10	37.60
25	1	-16	25.4	441-441RH-461LT-462-462ST	46	80C-B16	X		X	29	38.10	38.60
32	1-1/4	-20	31.8	492-492ST	46	80C-B20			X	35	43.95	44.45
32	1-1/4	-20	31.8	461LT-462-462ST	46	80C-B20	X		X	35	44.95	45.45

- 1) die ring  
2) base plate  
3) adapter bowl

Dimensions shown may be changed at any time without prior notice. These crimping tables are intended as a guide. Before crimping hoses and fittings it must be ensured that you have the most recent crimping dimensions. Please contact your local Parker sales office or [HPDE\\_Helpdesk@parker.com](mailto:HPDE_Helpdesk@parker.com)  
Crimp Charts Status: 2011-05-17

# Parkrimp® 2

## 48 Series

Hose I.D.				Hose type	Fitting series	Die set	1) 83C-R02	2) 83C-R02H	3) 83C-0CB	Insert depth mm	Crimp diameter		Stainless steel 5)
DN	Inch	Size	mm								mm	mm	
6	1/4	-4	6.3	421SN-422-441-441RH-451TC-461LT-462-462ST-471TC-472TC-477-493	48	80C-C04			X	22	16.40	16.90	
6	1/4	-4	6.3	301SN-302-304-421WC-601	48	80C-C04	X		X	22	17.40	17.90	
8	5/16	-5	7.9	421SN-422-441-441RH-461LT-462-462ST-471TC-472TC-477-493	48	80C-C05			X	24	18.05	18.55	
8	5/16	-5	7.9	301SN-302	48	80C-C05	X		X	24	19.05	19.55	
10	3/8	-6	9.5	421SN-422-436-441-441RH-451TC-461LT-462-462ST-471TC-472TC-477-493	48	80C-C06			X	22	20.35	20.85	
10	3/8	-6	9.5	301SN-302	48	80C-C06	X		X	22	21.35	21.85	
12	1/2	-8	12.7	421SN-422-426-436-441-441RH-451TC-461LT-462-462ST-471TC-472TC-477-493	48	80C-C08			X	24	23.35	23.85	
12	1/2	-8	12.7	301SN-302	48	80C-C08	X		X	24	24.40	24.90	
16	5/8	-10	15.9	421SN-422-426-436-441-441RH-451TC-461LT-462-462ST-471TC-472TC-477	48	80C-C10			X	25	26.65	27.15	
16	5/8	-10	15.9	301SN-302	48	80C-C10	X		X	25	27.70	28.20	
20	3/4	-12	19.1	421SN-422-426-436-441-441RH-451TC-461LT-462-462ST-471TC-472TC-477	48	80C-C12			X	25	30.50	31.00	
20	3/4	-12	19.1	301SN-302	48	80C-C12	X		X	25	31.50	32.00	
20	3/4	-12	19.1	811	48	80C-C12	X	X (4)	X	25	32.50	33.00	
25	1	-16	25.4	421SN-422-426-436-441-441RH-451TC-461LT-462-462ST-471TC-472TC-477	48	80C-C16			X	30	38.10	38.60	
25	1	-16	25.4	301SN-302	48	80C-C16	X		X	30	39.05	39.55	
25	1	-16	25.4	811	48	80C-C16	X	X (4)	X	30	40.05	40.55	
32	1-1/4	-20	31.8	421RH-421SN-422-426-472TC	48	80C-C20			X	46	50.05	50.55	
32	1-1/4	-20	31.8	421RH-421SN-422-426-472TC	48	83C-C20H				46	50.05	50.55	
32	1-1/4	-20	31.8	301SN-302-304-811-881	48	80C-C20	X		X	46	51.05	51.55	
32	1-1/4	-20	31.8	301SN-302-304-811-881	48	83C-C20H		X		46	51.05	51.55	
40	1-1/2	-24	38.1	421RH-421SN-422-426-471TC-472TC	48	83C-C24				37	58.15	58.65	•
40	1-1/2	-24	38.1	301SN-302-304-811-881	48	83C-C24		X		37	59.15	59.65	•
50	2	-32	50.8	421RH-421SN-422-426-471TC-472TC	48	83C-C32				47	69.45	69.95	•
50	2	-32	50.8	301SN-302-304-811-881	48	83C-C32		X		47	70.45	70.95	•

1) die ring

2) base plate

3) adapter bowl

4) put plate 83C-R02H between adaptor bowl 83C-0CB and ring 83C-R02

5) Crimp diameters for stainless steel fittings can be up to 0.25 mm larger than for standard steel fittings.

Dimensions shown may be changed at any time without prior notice. These crimping tables are intended as a guide. Before crimping hoses and fittings it must be ensured that you have the most recent crimping dimensions. Please contact your local Parker sales office or [HPDE\\_Helpdesk@parker.com](mailto:HPDE_Helpdesk@parker.com)

Crimp Charts Status: 2011-05-17

# Parkrimp® 2

## 70, 71, 73, 76, 77, 78, 79, S6 Series

Hose I.D.				Hose type	Fitting series	Die set	1) 83C-R02	2) 83C-R02H	3) 83C-0CB	Insert depth mm	min. Crimp length mm	Crimp diameter		Stainless steel 4)
DN	Inch	Size	mm									mm	mm	
10	3/8	-6	9.5	371LT-372-372RH-372TC-701-701ST	70	83C-D06	X		X	27		25.15	25.65	•
10	3/8	-6	9.5	721TC	71	83C-D06			X	28		24.15	24.65	•
12	1/2	-8	12.7	371LT-372-372RH-372TC-701-F42	70	83C-D08	X		X	33		28.95	29.45	•
12	1/2	-8	12.7	721TC	71	83C-D08			X	33		27.95	28.45	•
12	1/2	-8	12.7	787TC-797TC	77	80C-CS08	X		X	35		23.65	24.15	
16	5/8	-10	15.9	371LT-372-372RH-372TC-701	70	83C-D10	X		X	35		32.00	32.50	•
16	5/8	-10	15.9	721TC	71	83C-D10			X	36		31.00	31.50	•
16	5/8	-10	15.9	787TC-797TC	77	80C-CS10	X		X	39		26.85	27.35	
20	3/4	-12	19.1	371LT-372-372RH-372TC-701	70	83C-D12	X		X	38		35.40	35.90	•
20	3/4	-12	19.1	721TC-774	71	83C-D12			X	37		34.40	34.90	•
20	3/4	-12	19.1	731	73	80C-L12			X	48		36.05	36.55	
20	3/4	-12	19.1	731	73	83C-L12				48		36.05	36.55	
20	3/4	-12	19.1	761	76	83C-L12				59		39.15	39.65	
20	3/4	-12	19.1	781-782TC	78	80C-L12			X	48		36.05	36.55	•
20	3/4	-12	19.1	781-782TC	78	83C-L12				48		36.05	36.55	•
20	3/4	-12	19.1	791TC-792TC-F42	79	80C-L12			X	56	54.0	36.05	36.55	
20	3/4	-12	19.1	791TC-792TC-F42	79	83C-L12				56	54.0	36.05	36.55	
20	3/4	-12	19.1	787TC-797TC	77	80C-CS12	X		X	45		31.65	32.15	
25	1	-16	25.4	371LT-372-372RH-372TC-701	70	83C-D16	X		X	46		44.05	44.55	•
25	1	-16	25.4	371LT-372-372RH-372TC-701	70	83C-D16H		X		46		44.10	44.60	•
25	1	-16	25.4	721TC-774	71	83C-D16			X	45		43.05	43.55	•
25	1	-16	25.4	721TC-774	71	83C-D16H				45		43.05	43.55	•
25	1	-16	25.4	731	73	80C-L16			X	51		43.95	44.45	
25	1	-16	25.4	731	73	83C-L16				51		43.95	44.45	
25	1	-16	25.4	761	76	83C-L16				65		47.40	47.90	
25	1	-16	25.4	781-782TC	78	80C-L16			X	51		43.95	44.45	•
25	1	-16	25.4	781-782TC	78	83C-L16				51		43.95	44.45	•
25	1	-16	25.4	791TC-792TC-F42	79	80C-L16			X	58	57.0	43.95	44.45	
25	1	-16	25.4	791TC-792TC-F42	79	83C-L16				58	57.0	43.95	44.45	
25	1	-16	25.4	787TC-797TC	77	83C-CS16		X		54		39.15	39.65	
32	1.1/4	-20	31.8	701	70	83C-D20H		X		45		52.45	52.95	•
32	1.1/4	-20	31.8	721TC-774	71	83C-D20			X	46		51.45	51.95	•
32	1.1/4	-20	31.8	721TC-774	71	83C-D20H				46		51.45	51.95	•
32	1.1/4	-20	31.8	731	73	83C-L20				64		54.35	54.85	
32	1.1/4	-20	31.8	781-782TC	78	83C-L20				64		54.35	54.85	•
32	1.1/4	-20	31.8	791TC-F42	79	83C-L20				71	70.0	54.35	54.85	
32	1.1/4	-20	31.8	787TC-797TC	77	83C-CS20		X		64		50.05	50.55	
40	1.1/2	-24	38.1	701	70	83C-D24		X		55		59.15	59.65	
40	1.1/2	-24	38.1	721TC-722TC-774	71	83C-D24				59		58.15	58.65	•
40	1.1/2	-24	38.1	731	73	83C-L24				63		61.95	62.45	
40	1.1/2	-24	38.1	781-782TC	78	83C-L24				63		61.95	62.45	•
40	1.1/2	-24	38.1	791TC	79	83C-L24				75	73.0	61.95	62.45	
50	2	-32	50.8	721TC-722TC-774	71	83C-D32				63		70.50	71.00	•
50	2	-32	50.8	731	73	83C-L32				72		76.85	77.35	
50	2	-32	50.8	P35	S6	83C-L32				87	86.4	76.85	77.35	

1) die ring

2) base plate

3) adapter bowl

4) Crimp diameters for stainless steel fittings can be up to 0.25 mm larger than for standard steel fittings.

Dimensions shown may be changed at any time without prior notice. These crimping tables are intended as a guide. Before crimping hoses and fittings it must be ensured that you have the most recent crimping dimensions. Please contact your local Parker sales office or [HPDE\\_Helpdesk@parker.com](mailto:HPDE_Helpdesk@parker.com)  
Crimp Charts Status: 2011-05-17

# Adjustable Crimper

## V4/V6/VB Series

Hose I.D.				Hose type	Fitting series	Skiving length		Crimping diameter ± 0.2 mm	Shell ovalization	Shell conicity	Die set	Length min. mm
DN	Inch	Size	mm			internal ± 1 mm	external ± 1 mm					
16	5/8	-10	15.9	H31 - H31TC - H31ST	V4	14.5	50.0	30.40	0.2	0.6	PB239-28	70
16	5/8	-10	15.9	R42TC - R42ST	V4	14.5	50.0	30.40 *)	0.2	0.6	PB239-28	70
16	5/8	-10	15.9	R50TC	V4	14.5	50.0	30.10	0.2	0.6	PB239-28	70
20	3/4	-12	19.1	H29 - H29TC - H29ST	V4	15.0	52.0	33.90 *)	0.2	0.6	PB239-32	70
20	3/4	-12	19.1	H31 - H31TC - H31ST	V4	15.0	52.0	33.90	0.2	0.6	PB239-32	70
20	3/4	-12	19.1	R35	V4	15.0	52.0	33.90	0.2	0.6	PB239-32	70
20	3/4	-12	19.1	R42 - R42TC - R42ST	V4	15.0	52.0	33.90 *)	0.2	0.6	PB239-32	70
20	3/4	-12	19.1	R50TC	V4	15.0	52.0	34.40	0.2	0.6	PB239-32	70
25	1	-16	25.4	H29 - H29TC - H29ST	V4	17.0	65.0	42.50 *)	0.2	0.6	PB239L-40	85
25	1	-16	25.4	H31 - H31TC - H31ST	V4	17.0	65.0	41.60	0.2	0.6	PB239L-40	85
25	1	-16	25.4	R35	V4	17.0	65.0	42.50	0.2	0.6	PB239L-40	85
25	1	-16	25.4	R42 - R42TC - R42ST	V4	17.0	65.0	42.50 *)	0.2	0.6	PB239L-40	85
25	1	-16	25.4	R50TC	V4	17.0	65.0	42.20	0.2	0.6	PB239L-40	85
25	1	-16	25.4	R50TC-SP6	VB	17.0	65.0	46.50	0.2	0.6	PB239L-44	85
32	1-1/4	-20	31.8	H29 - H29TC - H29ST	V4	21.5	74.0	50.20 *)	0.3	1.0	PB239L-50	100
32	1-1/4	-20	31.8	R35	V4	21.5	74.0	50.20	0.3	1.0	PB239L-50	100
32	1-1/4	-20	31.8	R42	V6	22.0	58.0	55.50 *)	0.3	1.0	PB232L-54	100
32	1-1/4	-20	31.8	R50TC	V6	22.0	58.0	57.00	0.2	0.6	PB232L-54	100
40	1-1/2	-24	38.1	H29 - H29TC - H29ST	V4	22.0	81.0	57.30 *)	0.3	1.0	PB232L-57	110
40	1-1/2	-24	38.1	R35	V6	22.0	65.0	63.20	0.3	1.0	PB232L-62	110
40	1-1/2	-24	38.1	R42	V6	22.0	65.0	63.20 *)	0.3	1.0	PB232L-62	110
50	2	-32	50.8	H29 - H29TC - H29ST	V4	29.0	85.0	73.50 *)	0.3	1.0	PB232L-71	110
50	2	-32	50.8	R35	V6	22.0	75.0	77.30	0.3	1.0	PB232L-74	118
50	2	-32	50.8	R42	V6	22.0	75.0	78.00 *)	0.3	1.0	PB232L-78	118
65	2-1/2	-40	63.5	R35	V6	30.0	99.0	94.30	0.3	1.0	SpPB554-92	150

\*) Stainless Steel

Double swaging of shells should be avoided as it detrimentally influences the functionality and reduces the service life of the hose assembly.

It must be ensured that the crimper has enough crimping force to crimp the fitting and that the swage-dies are of sufficient length to cover the entire length of the shell.

**Only for use with adjustable crimpers - Minimum of 340 tons crimping force required for size -32  
- Minimum of 400 tons crimping force for size -40**

### Crimp Information

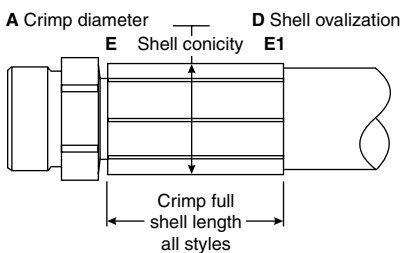

### Skive Information

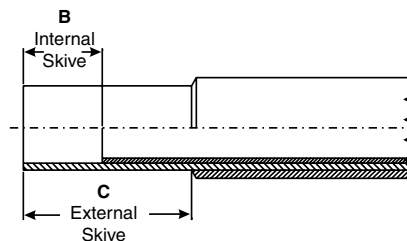

1. Use a vernier calliper to carry out two measurements at 90° in the middle of the shell (D). The ovaling is the difference between the min and the max measured diameters.
2. Use a vernier calliper to carry out two 90° opposed measurements on the shell surfaces as indicated (E - E1). The conicity is the difference between the medium diameter value E minus the medium diameter value E1, (E1 should not be greater than E)

Dimensions shown may be changed at any time without prior notice. These crimping tables are intended as a guide. Before crimping hoses and fittings it must be ensured that you have the most recent crimping dimensions. Please contact your local Parker sales office or HPDE\_Helpdesk@parker.com

Crimp Charts Status: 2011-12-16

# Adjustable Crimper

## VS Series

Hose I.D.				Hose type	Fitting series	Skiving length		Crimping diameter $\pm 0.2$ mm	Shell ovalization	Shell conicity	Die set	Length min. mm
DN	Inch	Size	mm			internal $\pm 1$ mm	external $\pm 1$ mm					
6	1/4	-4	6.3	H31 - H31ST - H31TC	VS	-	29.0	19.80	0.2	0.6	PB239-20	50
10	3/8	-6	9.5	H31 - H31ST - H31TC	VS	-	28.0	23.50	0.2	0.6	PB239-20	60
12	1/2	-8	12.7	H31 - H31ST - H31TC	VS	-	32.0	26.50	0.2	0.6	PB239-24	60

**Only for use with adjustable crimpers**

**Crimp Information**

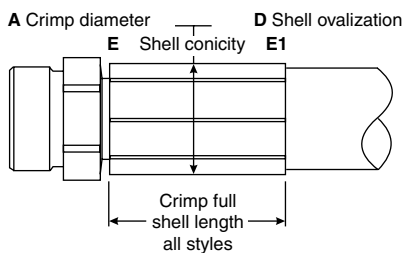

**Skive Information**

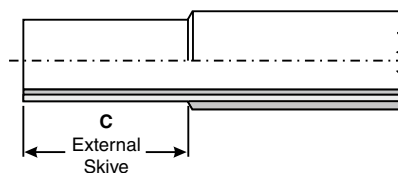

1. Use a vernier calliper to carry out two measurements at 90° in the middle of the shell (D). The ovaling is the difference between the min and the max measured diameters.
2. Use a vernier calliper to carry out two 90° opposed measurements on the shell surfaces as indicated (E - E1). The conicity is the difference between the medium diameter value E minus the medium diameter value E1, (E1 should not be greater than E)

Dimensions shown may be changed at any time without prior notice. These crimping tables are intended as a guide. Before crimping hoses and fittings it must be ensured that you have the most recent crimping dimensions. Please contact your local Parker sales office or [HPDE\\_Helpdesk@parker.com](mailto:HPDE_Helpdesk@parker.com)  
 Crimp Charts Status: 2011-12-16

Part Number	page	Part Number	page	Part Number	page	Part Number	page
201	B2a-1	10646	Cb-23	19126	B2b-4	115VS	Dj-11
206	B2a-2	10648	Cb-23	19146	Cb-19	117V4	Dk-13
213	B2a-3	10670	Db-9	19148	Cb-19	117V6	Dk-13
285	B2a-5	10671	Dc-8	19226	B2b-3	117VS	Dj-11
293	B2a-6	10673	Dd-6	19246	Cb-13	119V4	Dk-14
302	Ca-3	10677	Df-8	19248	Cb-13	119V6	Dk-14
304	Ca-4	10678	Dg-6	19270	Db-5	119VS	Dj-12
372	Da-2	10826	B2b-6	19271	Dc-5	11C46	Cb-9
402	Ca-6	10846	Cb-24	19273	Dd-3	11C48	Cb-9
412	Ca-7	10848	Cb-24	19277	Df-3	11C70	Db-4
422	Ca-11	11546	Cb-28	19278	Dg-3	11C71	Dc-4
424	Ca-12	11548	Cb-28	30182	B1b-12	11C73	Dd-2
426	Ca-13	11570	Db-11	30282	B1b-12	11C77	Df-2
436	Ca-14	11571	Dc-10	30382	B1b-13	11C78	Dg-2
441	Ca-15	11573	Dd-8	30682	B1b-13	11C79	Dh-2
451	Ca-17	11577	Df-10	30882	B1b-14	11CV4	Dk-5
462	Ca-20	11578	Dg-8	33482	B1b-11	11CV6	Dk-5
463	Ca-22	11671	Dc-10	33782	B1b-15	11CVS	Dj-4
477	Ca-24	11746	Cb-29	33982	B1b-15	137V4	Dk-10
492	Ca-26	11748	Cb-29	34982	B1b-7	137V6	Dk-10
493	Ca-28	11770	Db-11	36882	B1b-13	137VS	Dj-9
601	B2a-7	11771	Dc-11	38282	B1b-19	139V4	Dk-11
611	B2a-8	11773	Dd-8	39182	B1b-11	139V6	Dk-11
681	B2a-10	11777	Df-10	39282	B1b-9	139VS	Dj-10
692	Ca-29	11778	Dg-8	405.906	Ea-20	13V26	B2b-6
701	Da-5	11946	Cb-30	711509	Eb-4	13V26	B2b-6
731	Da-7	11948	Cb-30	853009	Eb-3	13V46	Cb-25
761	Da-8	11970	Db-12	16E77	Df-12	13V48	Cb-25
774	Da-10	11971	Dc-11	100V4	Dk-1	13VVS	Dj-9
781	Da-11	11973	Dd-9	100V6	Dk-1	13W26	B2b-7
801	B1a-1	11977	Df-11	100VB	Dk-1	13W26	B2b-7
804	B1a-2	11978	Dg-9	100VS	Dj-1	13W46	Cb-26
811	Ca-31	13346	Cb-24	101S6	Di-1	13W48	Cb-26
831	B1a-5	13348	Cb-24	101V4	Dk-9	13W70	Db-10
836	B1a-6	13746	Cb-25	101V6	Dk-9	13WVS	Dj-10
881	Ca-32	13748	Cb-25	101VS	Dj-8	13Y46	Cb-27
10126	B2b-5	13770	Db-10	103V4	Dk-9	13Y48	Cb-27
10146	Cb-20	13771	Dc-9	103V6	Dk-9	14A73	Dd-8
10148	Cb-20	13773	Dd-6	103VS	Dj-8	14A77	Df-10
10170	Db-8	13777	Df-8	106S6	Di-1	14A78	Dg-8
10171	Dc-7	13778	Dg-6	106V4	Dk-10	14AS6	Di-2
10173	Dd-5	13946	Cb-26	106V6	Dk-10	14AV4	Dk-12
10177	Df-7	13948	Cb-26	106VS	Dj-9	14AV6	Dk-12
10178	Dg-5	13970	Db-10	10C46	Cb-8	14F73	Dd-8
10346	Cb-21	13971	Dc-9	10C48	Cb-8	14F77	Df-10
10348	Cb-21	13973	Dd-7	10C70	Db-3	14F78	Dg-8
10370	Db-8	13977	Df-9	10C71	Dc-3	14FS6	Di-2
10371	Dc-7	13978	Dg-7	10C73	Dd-1	14FV4	Dk-13
10373	Dd-5	14146	Cb-27	10C77	Df-1	14FV6	Dk-13
10377	Df-7	14148	Cb-27	10C78	Dg-1	14N73	Dd-9
10378	Dg-5	14926	B2b-2	10C79	Dh-1	14N77	Df-11
10446	Cb-22	14946	Cb-12	10CV4	Dk-4	14N78	Dg-9
10448	Cb-22	14948	Cb-12	10CV6	Dk-4	14NS6	Di-2
10546	Cb-22	16826	B2b-5	10CVS	Dj-4	14NV4	Dk-14
10548	Cb-22	16846	Cb-23	115V4	Dk-12	14NV6	Dk-14
10626	B2b-5	16848	Cb-23	115V6	Dk-12	159PT26	B2b-10



Part Number	page	Part Number	page	Part Number	page	Part Number	page
15H26	B2b-9	1A0VB	Dk-29	1CE26	B2b-1	1EC77	Df-5
15LPT26	B2b-11	1B126	B2b-3	1CE46	Cb-2	1EN46	Cb-47
15S26	B2b-9	1B146	Cb-14	1CE48	Cb-2	1EN48	Cb-47
15T26	B2b-10	1B148	Cb-14	1CE70	Db-1	1ET46	Cb-48
168VS	Dj-9	1B170	Db-5	1CE71	Dc-1	1ET48	Cb-48
16A46	Cb-31	1B171	Dc-5	1CEV4	Dk-2	1EU46	Cb-47
16A48	Cb-31	1B173	Dd-3	1CEV6	Dk-2	1EU48	Cb-47
16A70	Db-12	1B177	Df-3	1CEVS	Dj-2	1F246	Cb-41
16A71	Dc-12	1B178	Dg-3	1CF26	B2b-2	1F248	Cb-41
16A73	Dd-9	1B1V4	Dk-6	1CF46	Cb-3	1F273	Dd-16
16A77	Df-11	1B1V6	Dk-6	1CF48	Cb-3	1F446	Cb-42
16A78	Dg-9	1B1VS	Dj-6	1CF70	Db-2	1F448	Cb-42
16A79	Dh-3	1B226	B2b-4	1CF71	Dc-2	1F470	Db-18
16AS6	Di-3	1B246	Cb-15	1CFV4	Dk-3	1F473	Dd-16
16AV4	Dk-15	1B248	Cb-15	1CFV6	Dk-3	1F4V4	Dk-26
16AV6	Dk-15	1B270	Db-6	1CFVS	Dj-3	1F4VS	Dj-16
16AVS	Dj-12	1B271	Dc-6	1CW46	Cb-44	1F646	Cb-42
16F46	Cb-31	1B273	Dd-4	1CW48	Cb-44	1F648	Cb-42
16F48	Cb-31	1B277	Df-4	1D046	Cb-4	1F946	Cb-43
16F70	Db-13	1B278	Dg-4	1D048	Cb-4	1F948	Cb-43
16F71	Dc-12	1B2V4	Dk-7	1D070	Db-2	1FA46	Cb-43
16F73	Dd-10	1B2V6	Dk-7	1D071	Dc-2	1FA48	Cb-43
16F77	Df-12	1B2VS	Dj-7	1D246	Cb-10	1FG46	Cb-41
16F78	Dg-10	1B446	Cb-16	1D248	Cb-10	1FG48	Cb-41
16F79	Dh-3	1B448	Cb-16	1D270	Db-4	1FG70	Db-18
16FS6	Di-3	1B546	Cb-19	1D271	Dc-4	1FGV4	Dk-26
16FV4	Dk-16	1B548	Cb-19	1D273	Dd-2	1FGVS	Dj-16
16FV6	Dk-16	1C046	Cb-4	1D277	Df-2	1FU46	Cb-39
16FVS	Dj-13	1C048	Cb-4	1D278	Dg-2	1FU48	Cb-39
16N46	Cb-32	1C346	Cb-5	1D2V4	Dk-5	1GU46	Cb-39
16N48	Cb-32	1C348	Cb-5	1D2V6	Dk-5	1GU48	Cb-39
16N70	Db-13	1C446	Cb-5	1D2VS	Dj-5	1J146	Cb-37
16N71	Dc-13	1C448	Cb-5	1D946	Cb-18	1J148	Cb-37
16N73	Dd-10	1C546	Cb-6	1D948	Cb-18	1J170	Db-16
16N77	Df-13	1C548	Cb-6	1D970	Db-7	1J546	Cb-37
16N78	Dg-10	1C646	Cb-11	1D971	Dc-6	1J548	Cb-37
16N79	Dh-4	1C648	Cb-11	1D973	Dd-4	1J746	Cb-35
16NS6	Di-3	1C946	Cb-7	1D977	Df-6	1J748	Cb-35
16NV4	Dk-17	1C948	Cb-7	1D978	Dg-4	1J770	Db-15
16NV4	Dk-18	1C970	Db-3	1D9V4	Dk-7	1J771	Dc-15
16NV6	Dk-17	1C971	Dc-3	1D9V6	Dk-7	1J773	Dd-14
16NV6	Dk-18	1C973	Dd-1	1D9VS	Dj-7	1J777	Df-15
16NVS	Dj-13	1C977	Df-1	1DK46	Cb-46	1J778	Dg-14
18A76	De-1	1C978	Dg-1	1DK48	Cb-46	1J779	Dh-5
18AV4	Dk-27	1C979	Dh-1	1DX46	Cb-46	1J7V4	Dk-24
18AV6	Dk-27	1C9V4	Dk-4	1DX48	Cb-46	1J7V6	Dk-24
18F76	De-1	1C9V6	Dk-4	1EA46	Cb-16	1J7VS	Dj-14
18FV4	Dk-27	1C9VS	Dj-3	1EA48	Cb-16	1J946	Cb-36
18FV6	Dk-27	1CA26	B2b-1	1EA70	Db-6	1J948	Cb-36
18N76	De-1	1CA46	Cb-1	1EA77	Df-4	1J970	Db-15
18NV4	Dk-28	1CA48	Cb-1	1EB46	Cb-17	1J971	Dc-15
18NV6	Dk-28	1CA70	Db-1	1EB48	Cb-17	1J973	Dd-14
191V4	Dk-8	1CA71	Dc-1	1EB77	Df-5	1J977	Df-16
192V4	Dk-6	1CAV4	Dk-2	1EC46	Cb-17	1J978	Dg-14
192V6	Dk-6	1CAV6	Dk-2	1EC48	Cb-17	1J979	Dh-6
192VS	Dj-6	1CAVS	Dj-2	1EC70	Db-7	1J9V4	Dk-25

Part Number	page	Part Number	page	Part Number	page	Part Number	page
1J9V6	Dk-25	1XFV6	Dk-21	477ST	Ca-25	830M	B1a-4
1J9VS	Dj-15	1XG73	Dd-12	492ST	Ca-27	837BM	B1a-7
1JC26	B2b-8	1XG78	Dg-12	50H	Eb-1	837PU-Plus	B1a-8
1JC46	Cb-33	1XGV4	Dk-22	51H	Eb-1	838M	B1a-9
1JC48	Cb-33	1XGV6	Dk-22	600.4	Ea-16	83C-0CB	Ea-4
1JC70	Db-14	1XN73	Dd-12	611050G	B1b-22	83C-C20H	Ea-6
1JC71	Dc-14	1XN78	Dg-12	611050G	Eb-21	83C-C24	Ea-6
1JC73	Dd-13	1XNV4	Dk-22	611050HV	B1b-22	83C-C32	Ea-6
1JC77	Df-15	1XNV6	Dk-22	611050HV	Eb-21	83C-CS16	Ea-6
1JC78	Dg-13	1XU70	Db-19	611HT	B2a-9	83C-CS20	Ea-6
1JCV4	Dk-23	1XU71	Dc-16	681DB	B2a-11	83C-D06	Ea-6
1JCV6	Dk-23	1XU73	Dd-17	692Twin	Ca-30	83C-D06	Ea-6
1JCVS	Dj-14	1XY70	Db-19	721TC	Da-6	83C-D08	Ea-6
1JD46	Cb-38	2-0..	Eb-4	772LT	Da-9	83C-D08	Ea-6
1JD48	Cb-38	2-2..	Eb-5	782TC	Da-13	83C-D10	Ea-6
1JM46	Cb-38	221FR	B2a-4	787TC	Da-14	83C-D10	Ea-6
1JM48	Cb-38	301SN	Ca-1	791TC	Da-15	83C-D12	Ea-6
1JM70	Db-16	301TC	Ca-2	792TC	Da-15	83C-D12	Ea-6
1JM73	Dd-15	31D82	B1b-6	797TC	Da-16	83C-D16	Ea-6
1JM77	Df-16	33V82	B1b-15	80C-B04	Ea-6	83C-D16	Ea-6
1JM78	Dg-15	33W82	B1b-15	80C-B05	Ea-6	83C-D16H	Ea-6
1JMV4	Dk-25	351TC	Ca-5	80C-B06	Ea-6	83C-D16H	Ea-6
1JS46	Cb-34	35C82	B1b-20	80C-B08	Ea-6	83C-D20	Ea-6
1JS48	Cb-34	36C82	B1b-21	80C-B10	Ea-6	83C-D20H	Ea-6
1JS70	Db-14	371LT	Da-1	80C-B12	Ea-6	83C-D24	Ea-6
1JS71	Dc-14	372RH	Da-3	80C-B16	Ea-6	83C-D32	Ea-6
1JS73	Dd-13	372TC	Da-4	80C-B20	Ea-6	83CE-083U	Ea-4
1JS78	Dg-13	37C82	B1b-21	80C-C04	Ea-6	83C-E20	Ea-6
1JS79	Dh-5	39B82	B1b-8	80C-C05	Ea-6	83C-E24	Ea-6
1JSV4	Dk-24	39C82	B1b-8	80C-C06	Ea-6	83C-E32	Ea-6
1L946	Cb-27	3AF82	B1b-17	80C-C08	Ea-6	83C-L12	Ea-6
1L948	Cb-27	3B182	B1b-9	80C-C10	Ea-6	83C-L16	Ea-6
1MU46	Cb-40	3B282	B1b-10	80C-C12	Ea-6	83C-L20	Ea-6
1MU48	Cb-40	3C382	B1b-3	80C-C16	Ea-6	83C-L24	Ea-6
1MU70	Db-17	3C482	B1b-4	80C-C20	Ea-6	83C-L32	Ea-6
1MZ46	Cb-40	3C582	B1b-5	80C-CS08	Ea-6	83C-L32	Ea-6
1MZ48	Cb-40	3CA82	B1b-1	80C-CS10	Ea-6	83C-R02	Ea-4
1NW46	Cb-44	3CE82	B1b-1	80C-CS12	Ea-6	83C-U12	Ea-6
1NW48	Cb-44	3CF82	B1b-2	80C-E04	Ea-6	83C-U16	Ea-6
1PW46	Cb-45	3D082	B1b-2	80C-E05	Ea-6	85CE-00L	Ea-1
1PW48	Cb-45	3D982	B1b-10	80C-E06	Ea-6	85CE-00L	Ea-2
1PYV4	Dk-20	3DP82	B1b-19	80C-E08	Ea-6	85CE-061L	Ea-2
1X577	Df-13	3DR82	B1b-20	80C-E10	Ea-6	85CE-0HP	Ea-5
1X5V6	Dk-19	3FF82	B1b-17	80C-E12	Ea-6	85CE-1PH	Ea-3
1X5VB	Dk-29	3JC82	B1b-16	80C-E16	Ea-6	85CE-1PH	Ea-5
1X777	Df-14	3NM82	B1b-19	80C-L12	Ea-6	85CE-CHD	Ea-2
1X7V6	Dk-19	412ST	Ca-7	80C-L16	Ea-6	85C-R01	Ea-2
1X977	Df-14	421RH	Ca-8	821FR	B1a-3	85C-R02	Ea-2
1X9V6	Dk-20	421SN	Ca-9	82C-00L	Ea-5	85C-STD	Ea-1
1XA73	Dd-11	421WC	Ca-10	82C-2HP	Ea-5	85C-STD	Ea-2
1XA78	Dg-11	441RH	Ca-16	82CE-061L	Ea-1	8FH	Eb-1
1XAV4	Dk-21	451TC	Ca-18	82CE-0AP	Ea-5	AG	Eb-10
1XAV6	Dk-21	461LT	Ca-19	82CE-0EP	Ea-5	AM	Eb-3
1XF73	Dd-11	462ST	Ca-21	82CE-CHD	Ea-1	AR	Eb-3
1XF78	Dg-11	471TC	Ca-23	82C-R01	Ea-1	AS	Eb-11
1XFV4	Dk-21	472TC	Ca-23	82C-R02	Ea-1	CARG	Eb-5

Part Number	page	Part Number	page	Part Number	page	Part Number	page
EARG	Eb-4	SHS310/370	Ea-25	TH3-14-3PH	Ea-12	TH6-10-P40	Ea-19
EM 10.P	Ea-7	SHS-800	Ea-24	TH3-14-BS	Ea-12	TH6-10-P50	Ea-19
F42	Da-17	SS..	Eb-7	TH3-14-BT	Ea-12	TH6-10-P60	Ea-19
FS-F	Eb-13	T891179	Ea-9	TH3-15-3PH	Ea-13	TH6-6	Ea-16
FU-HMX	Ea-24	T891180	Ea-10	TH3-15-BAR	Ea-13	TH6-7	Ea-17
FU-HMX	Ea-25	T905871	Ea-10	TH3-15-BS	Ea-13	TH6-7-30	Ea-17
H29	Da-18	T906202	Ea-9	TH3-15-BTF	Ea-13	TH6-7-55	Ea-17
H29RH	Da-19	TA380/A	Ea-25	TH3-15-BTS	Ea-13	TH7-12	Ea-21
H29ST	Da-21	TA800/A	Ea-24	TH3-2	Ea-9	TH7-13	Ea-21
H29TC	Da-20	TH11-3	Eb-21	TH3-2-12VDC	Ea-8	TH7-14	Ea-22
H31	Da-22	TH2-10-3PH	Ea-27	TH3-3	Ea-10	TH7-15	Ea-22
H31ST	Da-24	TH2-11EK	Ea-29	TH4-10	Ea-14	TH8-800-BM	Ea-24
H31TC	Da-23	TH2-11EK	Ea-29	TH4-4U	Ea-15	TH8E-380-BM	Ea-25
H896137	B1b-22	TH2-11EL	Ea-29	TH4-7	Ea-14	TH8E-530	Ea-23
H896137	Eb-21	TH2-11EL-1	Ea-29	TH4-9	Ea-14	TH8E-530-12VDC	Ea-23
H899770	Ea-20	TH2-11ES	Ea-29	TH4-9-1	Ea-14	TH8E-530-BM	Ea-23
H899771	Ea-16	TH2-11ES-1	Ea-29	TH4E-11	Ea-15	TH8E-535-BM	Ea-23
H899959	Ea-16	TH2-11M-10	Ea-29	TH4E-11-TC	Ea-15	TH8-LUS	Ea-25
H905375-DE	Eb-20	TH2-11M-12	Ea-29	TH4E-11-TH	Ea-15	TM 160 x 2,5 x 20	Ea-7
H905375-FR	Eb-20	TH2-11M-16	Ea-29	TH5-3	Ea-20	TM250x2x40Z	Ea-8
H905375-GB	Eb-20	TH2-11M-20	Ea-29	TH5-3-BM	Ea-20	UPTH-11b-PW3	Ea-15
HG	Eb-14	TH2-11M-24	Ea-29	TH6-10-EL-7	Ea-18	UPTH-22b	Ea-15
Hoze-Oil	Eb-21	TH2-11M-32	Ea-29	TH6-10-H06	Ea-18	UPTS 100	Ea-15
HP-B	Eb-17	TH2-11M-4	Ea-29	TH6-10-H06	Ea-19	VERG	Eb-4
HS	Eb-19	TH2-11M-6	Ea-29	TH6-10-H08	Ea-18	VURG	Eb-4
M..	Eb-6	TH2-11M-8	Ea-29	TH6-10-H08	Ea-19	VW12182	B1b-18
M1H	Eb-1	TH2-12NK-1012	Ea-29	TH6-10-H10	Ea-18	WKS	Eb-16
M2H	Eb-1	TH2-12NK-1012	Ea-29	TH6-10-H10	Ea-19	WRA..	Eb-18
MS..	Eb-6	TH2-12NK-1620	Ea-29	TH6-10-H13	Ea-18	WRC..	Eb-18
P35	Da-12	TH2-12NK-1620	Ea-29	TH6-10-H13	Ea-19	WRF..	Eb-18
PB237.239.2L2	Ea-24	TH2-12NK-2432	Ea-29	TH6-10-H16	Ea-18	XARG	Eb-5
PB237.239.2L2	Ea-25	TH2-12NK-2432	Ea-29	TH6-10-H16	Ea-19		
PB266.239L	Ea-23	TH2-12NK-8	Ea-29	TH6-10-H19	Ea-18		
PBSET-237L-IH	Ea-25	TH2-12NT-10	Ea-29	TH6-10-H19	Ea-19		
PBSET-TH8-800	Ea-24	TH2-12NT-12	Ea-29	TH6-10-H25	Ea-18		
PBSET-TH8E-380	Ea-25	TH2-12NT-16	Ea-29	TH6-10-H25	Ea-19		
PBSET-TH8E-53X	Ea-23	TH2-12NT-20	Ea-29	TH6-10-H32	Ea-18		
PG	Eb-15	TH2-12NT-24	Ea-29	TH6-10-H32	Ea-19		
PS	Eb-12	TH2-12NT-32	Ea-29	TH6-10-H38	Ea-19		
PS	Eb-16	TH2-13-3PH	Ea-28	TH6-10-H50	Ea-19		
QDC239.3	Ea-23	TH2-13EL-1	Ea-29	TH6-10-HL-9-2	Ea-19		
QDC239.3	Ea-24	TH2-13ES-1	Ea-29	TH6-10-P10	Ea-18		
QDC239.3	Ea-25	TH2-13ET	Ea-29	TH6-10-P10	Ea-19		
QDS239S	Ea-23	TH2-13M-10	Ea-29	TH6-10-P12	Ea-18		
QDS239S	Ea-24	TH2-13M-12	Ea-29	TH6-10-P12	Ea-19		
QDS239S	Ea-25	TH2-13M-16	Ea-29	TH6-10-P14	Ea-18		
R3..	Eb-2	TH2-13M-20	Ea-29	TH6-10-P14	Ea-19		
R35	Da-25	TH2-13M-24	Ea-29	TH6-10-P18	Ea-18		
R35TC	Da-26	TH2-13M-32	Ea-29	TH6-10-P18	Ea-19		
R42	Da-27	TH2-13M-8	Ea-29	TH6-10-P22	Ea-18		
R42ST	Da-29	TH2-9-1PH	Ea-26	TH6-10-P22	Ea-19		
R42TC	Da-28	TH2-9-3PH	Ea-26	TH6-10-P26	Ea-18		
R50TC	Da-30	TH3-13-12V	Ea-11	TH6-10-P26	Ea-19		
R6..	Eb-2	TH3-13-3PH	Ea-11	TH6-10-P33	Ea-18		
S..	Eb-7	TH3-13-BS	Ea-11	TH6-10-P33	Ea-19		
SG	Eb-9	TH3-13-BT	Ea-11	TH6-10-P40	Ea-18		





# Parker's Motion & Control Technologies

At Parker, we're guided by a relentless drive to help our customers become more productive and achieve higher levels of profitability by engineering the best systems for their requirements. It means looking at customer applications from many angles to find new ways to create value. Whatever the motion and control technology need, Parker has the experience, breadth of product and global reach to consistently deliver. No company knows more about motion and control technology than Parker. For further information call free on 00800 27 27 5374.



## AEROSPACE

### Key Markets

- Aircraft engines
- Business & general aviation
- Commercial transports
- Land-based weapons systems
- Military aircraft
- Missiles & launch vehicles
- Regional transports
- Unmanned aerial vehicles

### Key Products

- Flight control systems & components
- Fluid conveyance systems
- Fluid metering delivery & atomization devices
- Fuel systems & components
- Hydraulic systems & components
- Inert nitrogen generating systems
- Pneumatic systems & components
- Wheels & brakes



## HYDRAULICS

### Key Markets

- Aerospace
- Aerial lift
- Agriculture
- Construction machinery
- Forestry
- Industrial machinery
- Mining
- Oil & gas
- Power generation & energy
- Truck hydraulics

### Key Products

- Diagnostic equipment
- Hydraulic cylinders & accumulators
- Hydraulic motors & pumps
- Hydraulic systems
- Hydraulic valves & controls
- Power take-offs
- Rubber & thermoplastic hose & couplings
- Tube fittings & adapters
- Quick disconnects



## CLIMATE CONTROL

### Key Markets

- Agriculture
- Air conditioning
- Food, beverage & dairy
- Life sciences & medical
- Precision cooling
- Processing
- Transportation

### Key Products

- CO<sup>2</sup> controls
- Electronic controllers
- Filter driers
- Hand shut-off valves
- Hose & fittings
- Pressure regulating valves
- Refrigerant distributors
- Safety relief valves
- Solenoid valves
- Thermostatic expansion valves



## PNEUMATICS

### Key Markets

- Aerospace
- Conveyor & material handling
- Factory automation
- Life science & medical
- Machine tools
- Packaging machinery
- Transportation & automotive

### Key Products

- Air preparation
- Brass fittings & valves
- Manifolds
- Pneumatic accessories
- Pneumatic actuators & grippers
- Pneumatic valves & controls
- Quick disconnects
- Rotary actuators
- Rubber & thermoplastic hose & couplings
- Structural extrusions
- Thermoplastic tubing & fittings
- Vacuum generators, cups & sensors





## PROCESS CONTROL

### Key Markets

- Chemical & refining
- Food, beverage & dairy
- Medical & dental
- Microelectronics
- Oil & gas
- Power generation

### Key Products

- Analytical sample conditioning products & systems
- Fluoropolymer chemical delivery fittings, valves & pumps
- High purity gas delivery fittings, valves & regulators
- Instrumentation fittings, valves & regulators
- Medium pressure fittings & valves
- Process control manifolds



## ELECTROMECHANICAL

### Key Markets

- Aerospace
- Factory automation
- Life science & medical
- Machine tools
- Packaging machinery
- Paper machinery
- Plastics machinery & converting
- Primary metals
- Semiconductor & electronics
- Textile
- Wire & cable

### Key Products

- AC/DC drives & systems
- Electric actuators
- Controllers
- Gantry robots
- Gearheads
- Human machine interfaces
- Industrial PCs
- Inverters
- Linear motors, slides and stages
- Precision stages
- Stepper motors
- Servo motors, drives & controls
- Structural extrusions



## FILTRATION

### Key Markets

- Food & beverage
- Industrial machinery
- Life sciences
- Marine
- Mobile equipment
- Oil & gas
- Power generation
- Process
- Transportation

### Key Products

- Analytical gas generators
- Compressed air & gas filters
- Condition monitoring
- Engine air, fuel & oil filtration & systems
- Hydraulic, lubrication & coolant filters
- Process, chemical, water & microfiltration filters
- Nitrogen, hydrogen & zero air generators



## SEALING & SHIELDING

### Key Markets

- Aerospace
- Chemical processing
- Consumer
- Energy, oil & gas
- Fluid power
- General industrial
- Information technology
- Life sciences
- Military
- Semiconductor
- Telecommunications
- Transportation

### Key Products

- Dynamic seals
- Elastomeric o-rings
- EMI shielding
- Extruded & precision-cut, fabricated elastomeric seals
- Homogeneous & inserted elastomeric shapes
- High temperature metal seals
- Metal & plastic retained composite seals
- Thermal management



## FLUID & GAS HANDLING

### Key Markets

- Aerospace
- Agriculture
- Bulk chemical handling
- Construction machinery
- Food & beverage
- Fuel & gas delivery
- Industrial machinery
- Mobile
- Oil & gas
- Transportation
- Welding

### Key Products

- Brass fittings & valves
- Diagnostic equipment
- Fluid conveyance systems
- Industrial hose
- PTFE & PFA hose, tubing & plastic fittings
- Rubber & thermoplastic hose & couplings
- Tube fittings & adapters
- Quick disconnects

ENGINEERING YOUR SUCCESS.

# Parker Worldwide

## Europe, Middle East, Africa

**AE – United Arab Emirates,**  
Dubai

Tel: +971 4 8127100  
parker.me@parker.com

**AT – Austria,** Wiener Neustadt

Tel: +43 (0)2622 23501-0  
parker.austria@parker.com

**AT – Eastern Europe,** Wiener  
Neustadt

Tel: +43 (0)2622 23501 900  
parker.easteurope@parker.com

**AZ – Azerbaijan,** Baku

Tel: +994 50 2233 458  
parker.azerbaijan@parker.com

**BE/LU – Belgium,** Nivelles

Tel: +32 (0)67 280 900  
parker.belgium@parker.com

**BY – Belarus,** Minsk

Tel: +375 17 209 9399  
parker.belarus@parker.com

**CH – Switzerland,** Etoy

Tel: +41 (0)21 821 87 00  
parker.switzerland@parker.com

**CZ – Czech Republic,** Klecany

Tel: +420 284 083 111  
parker.czechrepublic@parker.com

**DE – Germany,** Kaarst

Tel: +49 (0)2131 4016 0  
parker.germany@parker.com

**DK – Denmark,** Ballerup

Tel: +45 43 56 04 00  
parker.denmark@parker.com

**ES – Spain,** Madrid

Tel: +34 902 330 001  
parker.spain@parker.com

**FI – Finland,** Vantaa

Tel: +358 (0)20 753 2500  
parker.finland@parker.com

**FR – France,** Contamine s/Arve

Tel: +33 (0)4 50 25 80 25  
parker.france@parker.com

**GR – Greece,** Athens

Tel: +30 210 933 6450  
parker.greece@parker.com

**HU – Hungary,** Budapest

Tel: +36 23 885 470  
parker.hungary@parker.com

**IE – Ireland,** Dublin

Tel: +353 (0)1 466 6370  
parker.ireland@parker.com

**IT – Italy,** Corsico (MI)

Tel: +39 02 45 19 21  
parker.italy@parker.com

**KZ – Kazakhstan,** Almaty

Tel: +7 7272 505 800  
parker.easteurope@parker.com

**NL – The Netherlands,** Oldenzaal

Tel: +31 (0)541 585 000  
parker.nl@parker.com

**NO – Norway,** Asker

Tel: +47 66 75 34 00  
parker.norway@parker.com

**PL – Poland,** Warsaw

Tel: +48 (0)22 573 24 00  
parker.poland@parker.com

**PT – Portugal,** Leca da Palmeira

Tel: +351 22 999 7360  
parker.portugal@parker.com

**RO – Romania,** Bucharest

Tel: +40 21 252 1382  
parker.romania@parker.com

**RU – Russia,** Moscow

Tel: +7 495 645-2156  
parker.russia@parker.com

**SE – Sweden,** Spånga

Tel: +46 (0)8 59 79 50 00  
parker.sweden@parker.com

**SK – Slovakia,** Banská Bystrica

Tel: +421 484 162 252  
parker.slovakia@parker.com

**SL – Slovenia,** Novo Mesto

Tel: +386 7 337 6650  
parker.slovenia@parker.com

**TR – Turkey,** Istanbul

Tel: +90 216 4997081  
parker.turkey@parker.com

**UA – Ukraine,** Kiev

Tel +380 44 494 2731  
parker.ukraine@parker.com

**UK – United Kingdom,** Warwick

Tel: +44 (0)1926 317 878  
parker.uk@parker.com

**ZA – South Africa,** Kempton Park

Tel: +27 (0)11 961 0700  
parker.southafrica@parker.com

## North America

**CA – Canada,** Milton, Ontario

Tel: +1 905 693 3000

**US – USA,** Cleveland

Tel: +1 216 896 3000

## Asia Pacific

**AU – Australia,** Castle Hill

Tel: +61 (0)2-9634 7777

**CN – China,** Shanghai

Tel: +86 21 2899 5000

**HK – Hong Kong**

Tel: +852 2428 8008

**IN – India,** Mumbai

Tel: +91 22 6513 7081-85

**JP – Japan,** Tokyo

Tel: +81 (0)3 6408 3901

**KR – South Korea,** Seoul

Tel: +82 2 559 0400

**MY – Malaysia,** Shah Alam

Tel: +60 3 7849 0800

**NZ – New Zealand,** Mt Wellington

Tel: +64 9 574 1744

**SG – Singapore**

Tel: +65 6887 6300

**TH – Thailand,** Bangkok

Tel: +662 186 7000-99

**TW – Taiwan,** Taipei

Tel: +886 2 2298 8987

## South America

**AR – Argentina,** Buenos Aires

Tel: +54 3327 44 4129

**BR – Brazil,** Sao Jose dos Campos

Tel: +55 800 727 5374

**CL – Chile,** Santiago

Tel: +56 2 623 1216

**MX – Mexico,** Apodaca

Tel: +52 81 8156 6000

European Product Information Centre

Free phone: 00 800 27 27 5374

(from AT, BE, CH, CZ, DE, DK, EE, ES, FI,  
FR, IE, IL, IS, IT, LU, MT, NL, NO, PL, PT, RU,  
SE, SK, UK, ZA)



**Parker Hannifin Ltd.**

Tachbrook Park Drive

Tachbrook Park,

Warwick, CV34 6TU

United Kingdom

Tel.: +44 (0) 1926 317 878

Fax: +44 (0) 1926 317 855

parker.uk@parker.com

www.parker.com