

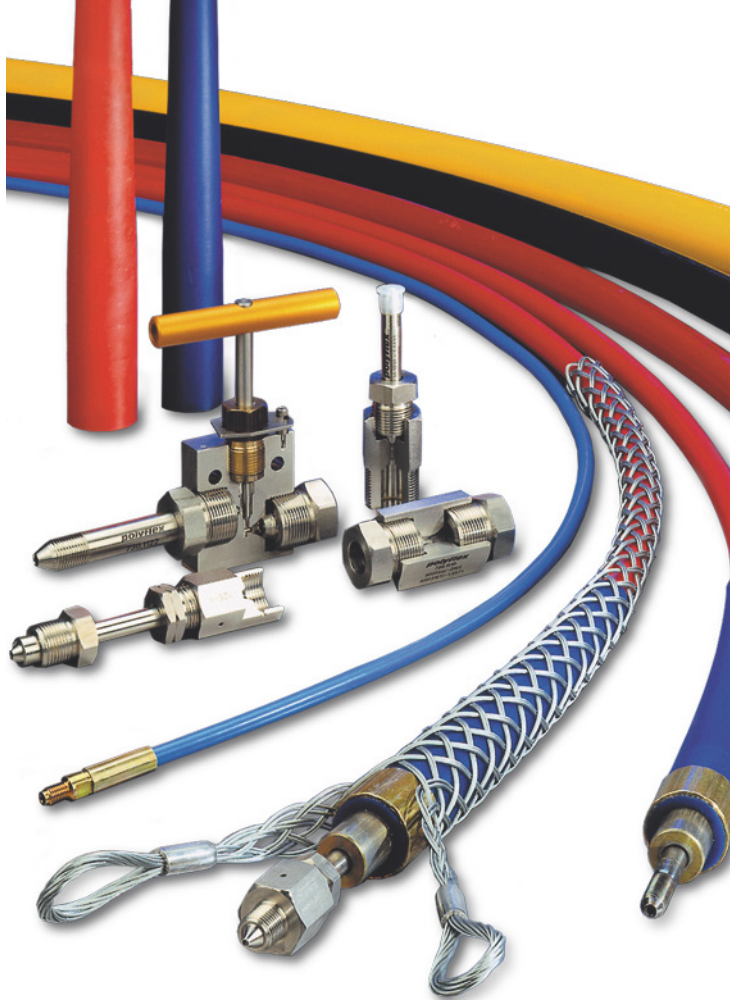

aerospace
climate control
electromechanical
filtration
fluid & gas handling
hydraulics
pneumatics
process control
sealing & shielding



Thermoplastic Hoses for Ultra High Pressure

Catalogue 4462 Global Edition



ENGINEERING YOUR SUCCESS.

Thermoplastic Hoses for Ultra High Pressure Facilities



Hüttenfeld / Germany



Wissembourg / France



Almelo / Netherlands



Ravenna / Ohio



Stafford / Texas

For Your Safety

The hose assemblies listed in this catalogue are all special constructions with the hose having up to eight spiral layers of steel wire. Due to this construction, pressures are achieved which far exceed German and international standards. These hose types are manufactured and tested according to the Polyflex standards which have proved to be effective over many years.

Polyflex hose assemblies are used at considerable working pressures. The critical area of a hose assembly is the connection between flexible hose and rigid fitting (crimping area). Only the use of original Polyflex components (hose, fittings and tooling) and full compliance with the Polyflex assembly instructions can guarantee safety and conformity with standards. It is essential that training be given to customers in the hose assembly process in order to make high quality Polyflex maximum pressure hose assemblies.

For the production and testing of the hose assemblies relevant to the applications, the guidelines and technical regulations as well as the protection and hazard prevention rulings must be adhered to.

You as the manufacturer of Polyflex hose assemblies are obliged to mark these hose assemblies according to the regulations and to verify their safety by a final pressure test.

Non-compliance with these rules can lead to the premature failure of the hose assembly and the loss of warranty.

- A** - *General Information*
- B** - *Sewer cleaning hose & fittings*
- C** - *High pressure tube cleaning hose & fittings*
- D** - *High pressure hose & fittings*
- E** - *Ultra-high pressure water jetting hose & fittings*
- F** - *Ultra-high pressure hose & fittings
for ultra-high water pressure equipment*
- G** - *Polyflex-Lok*
- H** - *Quick couplers*
- I** - *Accessories*
- J** - *Technical information*
- K** - *Index of part numbers*

Safety precautions



DO'S

- ☞ Treat high pressure hose with extreme caution. Parker Hannifin hoses are ultra high pressure hoses, not garden hoses and should be treated like a high pressure vessel
- ☞ Always visually inspect for frayed, damaged or wear spots before using
- ☞ Check the end connections for wear, rust, cracks or other deterioration which could produce a dangerous projectile
- ☞ Know the working pressures and burst pressures of all hoses before using them
- ☞ Always use clean, filtered medium to prolong hose life
- ☞ Always clean, drain and coil hoses after use
- ☞ Use only hoses assembled by an authorized Parker distributor



DON'TS

- ☞ Never fix a hose at the sleeves
- ☞ Never use a hose with cuts or wire showing through the outer cover
- ☞ Never use a hose with bubbles, blisters or kinks o Don't exceed the bend radius and pressure rating for each hose
- ☞ Don't run over or crush the hose with vehicles
- ☞ Hoses with corroded or leaking end connections should be avoided
- ☞ Avoid using a dirty medium or medium with sulfur compounds in it or don't bend the hose over scaffolding or pull heavy equipment with the hose
- ☞ Don't let hose support its own weight off towers or buildings
- ☞ Never use hose without hose arrestors (containment grips)
- ☞ Don't expect water jetting or hydraulic hose to last forever
- ☞ Don't change or repair a hose without instructions from the manufacturer
- ☞ Never disconnect a hose under pressure

Chapter A**General Information**

Hose selection chart by working pressure – safety factor 2.5:1	A-2
Hose selection chart by working pressure – safety factor 4:1	A-4
Hose fitting chart.....	A-6
Hose part numbering system.....	A-8
Hose end fitting part numbering system.....	A-8
Explanation of symbols.....	A-9

The content contained in this catalogue has been compiled with the greatest care and corresponds to the information currently available to us.

However, we would like to point out that we reserve the right to make technical changes and we kindly request you to contact us should you have any special questions.

Hose selection chart by working pressure – safety factor 2.5:1

Nominal size				Working pressure MPa [psi]							
				ESH	ESH250 / ESH250Plus	2240D / 2240D-TC	2244N-...W	2380N-...W	2388N-...W	2580N	2440D / 2440N
DN	size	mm	inch								
3	-02	3,2	1/8			110 [15,950]					207 [30,000]
4	-025	4,0	5/32			120 [17,400]					220 [31,900]
5	-03	4,8	3/16			100 [14,500]					180 [26,100]
6	-04	6,4	1/4			110 [15,950]		110 [15,950]	128 [18,560]		164 [23,780]
8	-05	7,9	5/16			90 [13,050]		100 [14,500]			150 [21,750]
10	-06	9,5	3/8				86 [12,470]			160 [23,200]	140 [20,300]
12	-08	12,7	1/2	20 [2,900]	25 [3,625]		88 [12,760]		110 [15,950]	140 [20,300]	130 [18,850]
20	-12	19,0	3/4	20 [2,900]	25 [3,625]					120 [17,400]	100 [14,500]
25	-16	25,4	1	20 [2,900]	25 [3,625]						90 [13,050]
32	-20	31,8	1 1/4	20 [2,900]	25 [3,625]						
Fitting series				EH / NC	EH / EJ	TX / PL	KX / 8X	KX	BS / 8X	BL	LX
Page				B-2	B-5/6	C-2/3	D-5	D-31	D-40	D-52	E-4



General remark:
 Ultra high pressure hoses are usually used with 2.5:1 safety factor, which is also specified in ISO 7751.

Working pressure MPa [psi]									
2440D-TC	2640D / 2640N	2648N	2740D	2741D	2748D	2840D	2841D	2848D	2849D
220 [31,900]	280 [40,600]		300 [43,500]						
180 [26,100]	250 [36,250]		280 [40,600]			400 [58,000]			
164 [23,780]									
150 [21,750]	210 [30,450]		250 [36,250]	250 [36,250]	280 [40,600]	300 [43,500]	300 [43,500]	320 [46,400]	380 [55,000]
	180 [26,100]	210 [30,450]	200 [29,000]			250 [36,250]			
	140 [20,300]	160 [23,200]							
	120 [17,400]	150 [21,750]							
LX	JX / 2X / 5X	CX / JX	2X / HX	2X	2X	2X / WX	2X	2X	WX
E-5	E-15	E-22	E-25	E-29	E-32/33	F-2	F-5	F-8	F-11

Hose selection chart by working pressure – safety factor 4:1

Nominal size												
				2244N	2022N-5K	2022N-10K	2340N	2380N	2380N-MSHA	2388N	2580N-MSHA	
DN	size	mm	inch									
3	-02	3,2	1/8									
4	-025	4,0	5/32	75 [10,875]				75 [10,875]				
5	-03	4,8	3/16									
6	-04	6,4	1/4		34.5 [5,000]	69 [10,000]	72 [10,440]		70 [10,150]	80 [11,600]		
8	-05	7,9	5/16					62.5 [9,060]				
10	-06	9,5	3/8	53.5 [7,755]	34.5 [5,000]	69 [10,000]		57.5 [8,337]			70 [10,150]	
12	-08	12,7	1/2	55 [7,795]	34.5 [5,000]	69 [10,000]		55 [7,975]			70 [10,150]	
20	-12	19,0	3/4									
25	-16	25,4	1									
32	-20	31,8	1 1/4	27.5 [3,990]				27.5 [3,985]				
Fitting series				8X / NX	55	8X / 3X / LX	8X	8X / LX / NX	8X / LX / NX	8X	BL	
Page				D-5	D-20	D-20	D-24	D-31	D-32	D-40	D-53	

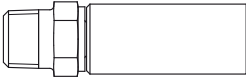
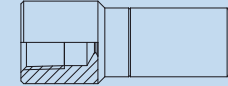
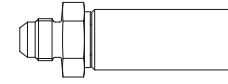
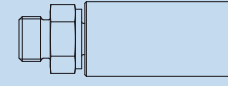
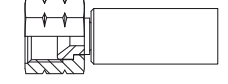
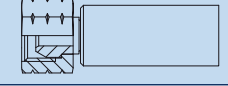
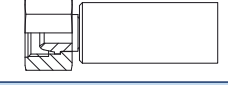
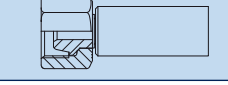
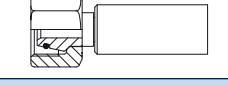

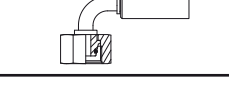
Hose fitting chart

Fitting	Fitting description	Fitting designation
	National Pipe Tapered (NPT) male	01
	National Pipe Tapered (NPT) female	02
	JIC male	03
	UNF male with O-ring	05
	JIC female swivel	06
	NPSM female swivel	07
	Metric female swivel light series	C3
	Metric female swivel heavy series	C6
	Metric female swivel heavy series with O-ring	C9
	Metric female swivel heavy series with O-ring 45° elbow	0C
	Metric female swivel heavy series with O-ring 90° elbow	1C

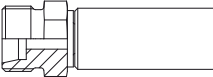
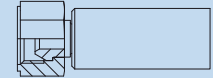
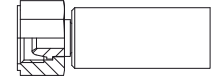
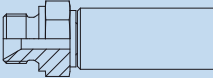
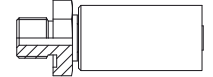
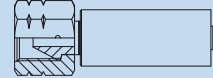
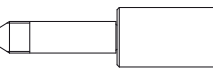
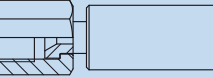
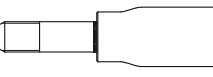
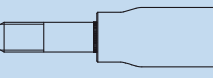
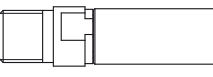
Hose fitting chart

Fitting	Fitting description	Fitting designation
	Metric male heavy series	D2
	BSP female swivel (60° cone)	92
	BSP female swivel (ballnose)	U0
	BSP male	D9 or 3B
	BSP male for USIT ring	Y9
	Type "M" female swivel	AY
	Medium pressure tube nipple	Y2
	Medium pressure female swivel	5Y
	High pressure tube nipple UNF-LH thread	Y4 or YA
	High pressure tube nipple metric-LH thread	YM
	BSP male nozzle nipple	YB

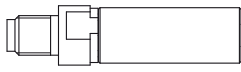
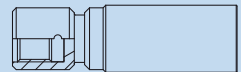
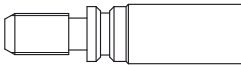
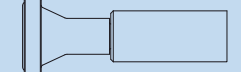
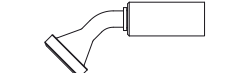
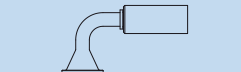
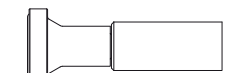
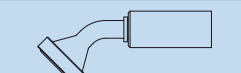
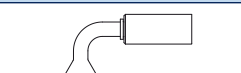
Hose fitting chart

Fitting	Fitting description	Fitting designation
	Metric male nozzle nipple	YZ
	Left hand female for water jetting nozzle	HY-LH
	UNF male nozzle nipple	YH
	SAE code 61 flange	15
	SAE code 61 flange 45° elbow	17
	SAE code 61 flange 90° elbow	19
	SAE code 62 flange	6A
	SAE code 62 flange 45° elbow	6F
	SAE code 62 flange 90° elbow	6N
	Male stecko	MB

Hose part numbering system



2440 N - 16 V37

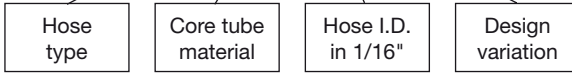

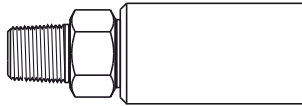

Hose end fitting part numbering system



6 01 LX - 8 - 8 C



Explanation of symbols

Symbol	Description
#	Part number
	Nominal inner diameter
	Nominal outer diameter
	Working pressure
	Burst pressure
	Bend radius
	Weight
	Fittings
	Thread size
	Wrench size
	Thickness

Chapter B
Sewer cleaning hose & fittings

Hose		
ESH	– Sewer cleaning hose.....	B-2
Related fittings		
192EH	– BSP female swivel (60° cone)	B-3
1D9EH	– BSP male	B-3
292NC	– BSP female swivel (60° cone)	B-4
2D9NC	– BSP male	B-4
Hose		
ESH250	– Sewer cleaning hose.....	B-5
ESH250^{plus}	– Sewer cleaning hose.....	B-6
Related fittings		
192EH	– BSP female swivel (60° cone)	B-7
1D9EH	– BSP male	B-7
292EJ	– BSP female swivel (60° cone)	B-8
2D9EJ	– BSP male	B-8

ESH – Sewer cleaning hose



APPLICATIONS • Hydrodynamic cleaning of sewers

CONSTRUCTION Core tube : Polyethylene compound, grey
 Pressure reinforcement : Two braided layers of high tensile synthetic yarn

Cover : Polyurethane compound
 Colour : Yellow

TEMPERATURE RANGE -10°C up to +50°C

#	Core tube				Pressure reinforcement			Cover		Bore diameter	Weight
	DN	size	mm	inch	mm	MPa	psi	MPa	psi		
ESH-08	12	-08	12.7	1/2	20.6	20	2,900	50	7250	100	0.23
ESH-12	20	-12	19.2	3/4	28.6	20	2,900	50	7250	125	0.37
ESH-16	25	-16	25.3	1	36.6	20	2,900	50	7250	150	0.59
ESH-20	32	-20	31.9	1 1/4	46.0	20	2,900	50	7250	225	0.89

NOTES

- ESH available as bulk hose on a drum
- Crimp on a Parkrimpsystem or on a free adjustable crimper

192EH – BSP female swivel (60° cone)

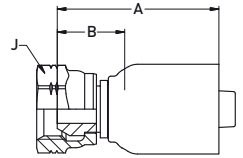

MATERIAL Carbon steel zinc plated

#	⊙				⌚	A	B	J	↗	
	DN	size	mm	inch					MPa	psi
192EH-08-08	12	-08	12.8	1/2	G 1/2	57	22	27	25	3,625
192EH-12-12	20	-12	19.6	3/4	G 3/4	61	22	32	25	3,625
192EH-16-16	25	-16	25.0	1	G 1	55	25	41	25	3,625
192EH-20-20	32	-20	32.0	1 1/4	G 1 1/4	80	32	50	25	3,625

Sewer cleaning

1D9EH – BSP male

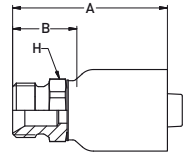

MATERIAL Carbon steel zinc plated

#	⊙				⌚	A	B	H	↗	
	DN	size	mm	inch					MPa	psi
1D9EH-08-08	12	-08	12.8	1/2	G 1/2	64	30	27	25	3,625
1D9EH-12-12	20	-12	19.6	3/4	G 3/4	72	33	32	25	3,625
1D9EH-16-16	25	-16	25.0	1	G 1	72	42	41	25	3,625
1D9EH-20-20	32	-20	32.0	1 1/4	G 1 1/4	93	45	50	25	3,625

292NC – BSP female swivel (60° cone)

Field attachable fitting

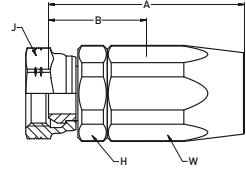
**MATERIAL** Carbon steel zinc plated

#	⊙				⌚	A	B	H	J	W	↗	
	DN	size	mm	inch							mm	psi
292NC-08-08	12	-08	12.8	1/2	G 1/2	77	37	27	27	27	17	2,465
292NC-12-12	20	-12	19.6	3/4	G 3/4	87	39	36	32	36	17	2,465
292NC-16-16	25	-16	25.0	1	G 1	100	50	46	46	46	17	2,465
292NC-20-20	32	-20	32.0	1 1/4	G 1 1/4	113	60	55	55	55	17	2,465

2D9NC – BSP male

Field attachable fitting

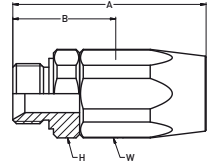
**MATERIAL** Carbon steel zinc plated

#	⊙				⌚	A	B	H	W	↗	
	DN	size	mm	inch						mm	psi
2D9NC-08-08	12	-08	12.8	1/2	G 1/2	75	35	27	27	17	2,465
2D9NC-12-12	20	-12	19.6	3/4	G 3/4	86	38	36	36	17	2,465
2D9NC-16-16	25	-16	25.0	1	G 1	100	50	46	46	17	2,465
2D9NC-20-20	32	-20	32.0	1 1/4	G 1 1/4	113	60	55	55	17	2,465

ESH250 – Sewer cleaning hose



APPLICATIONS • Hydrodynamic cleaning of sewers

CONSTRUCTION

- Core tube** : Thermoplastic Elastomere
- Pressure reinforcement** : Two braided layers of high tensile synthetic fiber, homogenous compound
- Cover** : Polyurethane, extreme abrasive and cut resistance
- Colour** : Red

TEMPERATURE RANGE -10°C up to +50°C

#	Ø				Ø			Ø		Ø		kg/m
	DN	size	mm	inch	mm	MPa	psi	MPa	psi	mm		
ESH250-08	12	-08	12.4	1/2	21.2	25	3,625	62.5	9,060	100	0.24	
ESH250-12	20	-12	19.0	3/4	28.6	25	3,625	62.5	9,060	125	0.40	
ESH250-16	25	-16	25.4	1	36.5	25	3,625	62.5	9,060	150	0.60	
ESH250-20	32	-20	32.0	1 1/4	46.0	25	3,625	62.5	9,060	225	1.00	

Hose assemblies

#	Length (m)						Fittings	
	Standard					max.	BSP female swivel	BSP male
	80	100	120	160	180			
ESH250-08	•	•	•	•	•	500	G 1/2	G 1/2
ESH250-12	•	•	•	•	•	500	G 3/4	G 3/4
ESH250-16	•	•	•	•	•	500	G 1	G 1
ESH250-20	•	•	•	•	•	400	G 1 1/4	G 1 1/4

NOTES

- Standard available hose assemblies see table above. Ordering example: ESH250-12-160
- Crimp your own assembly: ESH250 available as bulk hose on a drum
- Crimp on a Parkrimpsystem or on a free adjustable crimper

ESH250^{plus} – Sewer cleaning hose



APPLICATIONS • Hydrodynamic cleaning of sewers

CONSTRUCTION

- Core tube** : Thermoplastic Elastomere
- Pressure reinforcement** : Two braided layers of high tensile synthetic fiber, homogenous compound
- Cover** : Polyurethane, extreme abrasive and cut resistance
- Colour** : Green

TEMPERATURE RANGE -10°C up to +50°C

#	Ø				Ø		Ø		Ø		Ø	
	DN	size	mm	inch	mm	MPa	psi	MPa	psi	mm	kg/m	
ESH250Plus-08	12	-08	12.4	1/2	21.2	25	3,625	62.5	9,060	100	0.24	
ESH250Plus-12	20	-12	19.0	3/4	28.6	25	3,625	62.5	9,060	125	0.40	
ESH250Plus-16	25	-16	25.4	1	36.5	25	3,625	62.5	9,060	150	0.60	
ESH250Plus-20	32	-20	32.0	1 1/4	46.0	25	3,625	62.5	9,060	225	1.00	

Hose assemblies

#	Length (m)						Fittings	
	Standard					max.	BSP female swivel	BSP male
	80	100	120	160	180			
ESH250Plus-08	•	•	•	•	•	500	G 1/2	G 1/2
ESH250Plus-12	•	•	•	•	•	500	G 3/4	G 3/4
ESH250Plus-16	•	•	•	•	•	500	G 1	G 1
ESH250Plus-20	•	•	•	•	•	400	G 1 1/4	G 1 1/4

NOTES

- Standard available hose assemblies see table above. Ordering example: ESH250Plus-12-160
- Crimp your own assembly: ESH250Plus available as bulk hose on a drum
- Crimp on a Parkrimpsystem or on a free adjustable crimper

192EH – BSP female swivel (60° cone)

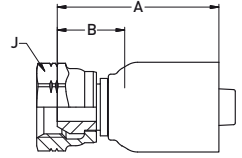

MATERIAL Carbon steel zinc plated

#	⊙				🌀	A	B	J	↗	
	DN	size	mm	inch					MPa	psi
192EH-08-08	12	-08	12.8	1/2	G 1/2	57	22	27	25	3,625
192EH-12-12	20	-12	19.6	3/4	G 3/4	61	22	32	25	3,625
192EH-16-16	25	-16	25.0	1	G 1	55	25	41	25	3,625
192EH-20-20	32	-20	32.0	1 1/4	G 1 1/4	80	32	50	25	3,625

Sewer cleaning

1D9EH – BSP male

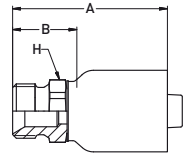

MATERIAL Carbon steel zinc plated

#	⊙				🌀	A	B	H	↗	
	DN	size	mm	inch					MPa	psi
1D9EH-08-08	12	-08	12.8	1/2	G 1/2	64	30	27	25	3,625
1D9EH-12-12	20	-12	19.6	3/4	G 3/4	72	33	32	25	3,625
1D9EH-16-16	25	-16	25.0	1	G 1	72	42	41	25	3,625
1D9EH-20-20	32	-20	32.0	1 1/4	G 1 1/4	93	45	50	25	3,625

292EJ – BSP female swivel (60° cone)

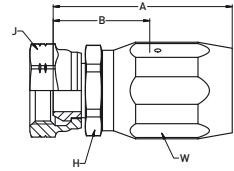

MATERIAL Carbon steel zinc plated

#	⊙				⌚	A	B	H	J	W	↗	
	DN	size	mm	inch							MPa	psi
292EJ-8-08	12	-08	12.8	1/2	G 1/2	71	33	27	27	27	18	2,610
292EJ-12-12	20	-12	19.6	3/4	G 3/4	82	37	32	32	36	18	2,610
292EJ-16-16	25	-16	25.0	1	G 1	89	48	41	41	46	18	2,610
292EJ-20-20	32	-20	32.0	1 1/4	G 1 1/4	112	59	50	50	55	18	2,610

2D9EJ – BSP male

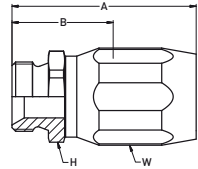

MATERIAL Carbon steel zinc plated

#	⊙				⌚	A	B	H	W	↗	
	DN	size	mm	inch						MPa	psi
2D9EJ-8-08	12	-08	12.8	1/2	G 1/2	70	32	27	27	18	2,610
2D9EJ-12-12	20	-12	19.6	3/4	G 3/4	83	38	32	36	18	2,610
2D9EJ-16-16	25	-16	25.0	1	G 1	91	50	41	46	18	2,610
2D9EJ-20-20	32	-20	32.0	1 1/4	G 1 1/4	112	59	50	55	18	2,610

Chapter C
High pressure tube cleaning hose & fittings
Hose

2240D – High pressure tube cleaning hose	C-2
2240D – TOUGH COVER High pressure tube cleaning hose.....	C-3

Related fittings

106TX – JIC female swivel.....	C-4
1AYTX – Type “M” female swivel	C-4
1C9TX – Metric female swivel heavy series with O-ring	C-5
1U0TX – BSP female swivel (ballnose).....	C-5
101TX – National Pipe Tapered (NPT) male.....	C-6
602PL – National Pipe Tapered (NPT) female.....	C-6
6HYPL – Left hand female for water jetting nozzle	C-7
63ZPL – Male water jetting nozzle	C-7
6ZEPL – Male water jetting nozzle.....	C-7
6EZPL – Male water jetting nozzle.....	C-8
1YZTX – Metric male nozzle nipple.....	C-8
1YBTX – BSP male nozzle nipple.....	C-9

2240D – High pressure tube cleaning hose

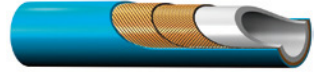

APPLICATIONS

- High pressure service for tube cleaning applications such as heat exchangers in the chemical and oil refining industries.
- Application as flexible lance at working pressures of 75 MPa and higher.







CONSTRUCTION

Core tube : Polyoxymethylene
Pressure reinforcement : Two spiral layers of high tensile steel wire

Cover : Polyamide
Colour : blue

TEMPERATURE RANGE

-10°C up to +70°C

#												
	DN	size	mm	inch	mm	MPa	psi	MPa	psi	mm	kg/m	
2240D-02V32	3	-02	3.0	1/8	7.0	110	15,950	275	39,875	60	0.07	
2240D-025V32	4	-025	4.0	5/32	7.7	120	17,400	300	43,500	75	0.10	
2240D-03V32	5	-03	4.7	3/16	9.5	100	14,500	250	36,250	95	0.13	
2240D-04V32	6	-04	6.3	1/4	11.5	110	15,950	275	39,875	110	0.20	
2240D-05V32	8	-05	8.0	5/16	13.3	90	13,050	225	32,625	120	0.25	

NOTES –

2240D-TOUGH COVER – High pressure tube cleaning hose



APPLICATIONS

- High pressure service for tube cleaning applications such as heat exchangers in the chemical and oil refining industries.
- Application as flexible lance at working pressures of 75 MPa and higher.

CONSTRUCTION

Core tube : Polyoxymethylene
Pressure reinforcement : Two spiral layers of high tensile steel wire

Cover : Polyamide
Colour : blue

TEMPERATURE RANGE

-10°C up to +70°C

#													
	DN	size	mm	inch	mm	MPa	psi	MPa	psi	mm	kg/m		
2240D-02V32-TC	3	-02	3.0	1/8	7.0	110	15,950	275	39,875	60	0.07		
2240D-025V32-TC	4	-025	4.0	5/32	7.7	120	17,400	300	43,500	75	0.10		
2240D-03V32-TC	5	-03	4.8	3/16	9.5	100	14,500	250	36,250	95	0.13		
2240D-04V32-TC	6	-04	6.4	1/4	11.5	110	15,950	275	39,875	110	0.20		
2240D-05V32-TC	8	-05	8.1	5/16	13.3	90	13,050	225	32,625	120	0.25		

NOTES -

106TX – JIC female swivel

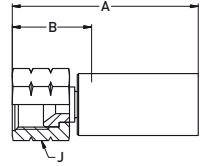

MATERIAL Carbon steel zinc plated

#	⊙				⋈	A	B	J	⊙	
	DN	size	mm	inch					MPa	psi
106TX-4-02W	3	-02	3.0	1/8	7/16-20 UNF	40	21	17	110	15,950
106TX-4-025W	4	-025	4.0	5/32	7/16-20 UNF	44	21	17	120	17,400
106TX-6-03W	5	-03	4.8	3/16	9/16-18 UNF	48	25	19	100	14,500
106TX-6-04W	6	-04	6.4	1/4	9/16-18 UNF	53	26	19	110	15,950

1AYTX – Type “M” female swivel

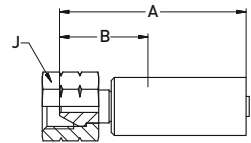

MATERIAL Carbon steel zinc plated

#	⊙				⋈	A	B	J	⊙	
	DN	size	mm	inch					MPa	psi
1AYTX-6-02W	3	-02	3.0	1/8	9/16-18 UNF	47	28	19	110	15,950
1AYTX-6-025W	4	-025	4.0	5/32	9/16-18 UNF	45	23	19	120	17,400
1AYTX-6-03W	5	-03	4.8	3/16	9/16-18 UNF	50	23	19	100	14,500
1AYTX-6-04W	6	-04	6.4	1/4	9/16-18 UNF	52	25	19	110	15,950
1AYTX-8-05W	8	-05	7.9	5/16	3/4-16 UNF	64	30	27	90	13,050

1C9TX – Metric female swivel heavy series with O-ring

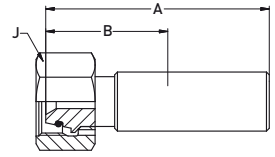

MATERIAL Carbon steel zinc plated

NOTE * DN4-6 with support ferrule – DN8 without support ferrule

#	⊙				📐	A	B	J	↻	
	DN	size	mm	inch					MPa	psi
1C9TX-16-02W	3	-02	3.0	1/8	M24x1.5	60	39	30	110	15,950
1C9TX-16-025W	4	-025	4.0	5/32	M24x1.5	66	35	30	120	17,400
1C9TX-16-03W	5	-03	4.8	3/16	M24x1.5	74	42	30	100	14,500
1C9TX-16-04W	6	-04	6.4	1/4	M24x1.5	70	44	30	110	15,950
1C9TX-16-05W *	8	-05	7.9	5/16	M24x1.5	71	38	30	90	13,050

Tube cleaning

1U0TX – BSP female swivel (ballnose)

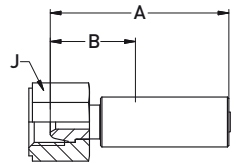

MATERIAL Carbon steel zinc plated

#	⊙				📐	A	B	J	↻	
	DN	size	mm	inch					MPa	psi
1U0TX-2-02W	3	-02	3.0	1/8	G 1/8	36	18	12	110	15,950
1U0TX-4-02W	3	-02	3.0	1/8	G 1/4	44	22	17	110	15,950
1U0TX-4-025W	4	-025	4.0	5/32	G 1/4	45	23	17	120	17,400
1U0TX-4-03W	5	-03	4.7	3/16	G 1/4	49	23	17	100	14,500
1U0TX-4-04W	6	-04	6.3	1/4	G 1/4	51	25	17	110	15,950
1U0TX-6-05W	8	-05	7.9	5/16	G 3/8	60	26	27	90	13,050

101TX – National Pipe Tapered (NPT) male

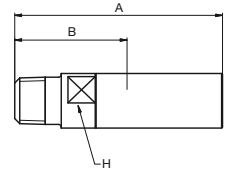

MATERIAL Carbon steel zinc plated

#	⊙				⌚	A	B	H	↻	
	DN	size	mm	inch					MPa	psi
101TX-1-02W	3	-02	3.0	1/8	1/16 NPT	46	25	10	103.4	15,000
101TX-2-02W	3	-02	3.0	1/8	1/8 NPT	44	22	10	103.4	15,000
101TX-1-025W	4	-025	4.0	5/32	1/16 NPT	47	25	10	103.4	15,000
101TX-2-025W	4	-025	4.0	5/32	1/8 NPT	49	27	10	103.4	15,000
101TX-4-025W	4	-025	4.0	5/32	1/4 NPT	56	34	13	103.4	15,000
101TX-2-03W	5	-03	4.8	3/16	1/8 NPT	54	27	10	103.4	15,000
101TX-4-03W	5	-03	4.8	3/16	1/4 NPT	61	34	13	103.4	15,000
101TX-4-04W	6	-04	6.4	1/4	1/4 NPT	62	35	13	103.4	15,000
101TX-4-05W	8	-05	7.9	5/16	1/4 NPT	69	35	13	103.4	15,000
101TX-6-05W	8	-05	7.9	5/16	3/8 NPT	69	35	17	103.4	15,000

602PL – National Pipe Tapered (NPT) female

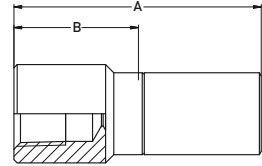

MATERIAL Carbon steel zinc plated

NOTE * ProLance fitting

#	⊙				⌚	A	B	R	↻	
	DN	size	mm	inch					MPa	psi
602PL-1-2A*	4	-025	4.0	5/32	1/16 NPT	38	22	11	103.4	15,000
602PL-2-3*	5	-03	4.8	3/16	1/8 NPT	42	21	13	103.4	15,000
602PL-4-4*	6	-04	6.4	1/4	1/4 NPT	60	28	16	99.9	14,490

6HYPL – Left hand female for water jetting nozzle

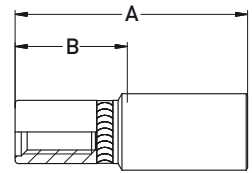

MATERIAL Carbon steel zinc plated

NOTE * ProLance fitting

#						A	B	R		
	DN	size	mm	inch		mm	mm	mm	MPa	psi
6HYPL-1-2*	3	-02	3.2	1/8	#12 - 28 UNF	29	13	10	103.4	15,000

Tube cleaning

63ZPL / 6ZEPL – Male water jetting nozzle

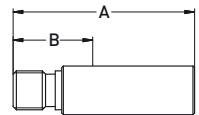

MATERIAL Carbon steel zinc plated / Stainless steel

NOTE * ProLance fitting

#						A	B	R		
	DN	size	mm	inch		mm	mm	mm	MPa	psi
63ZPL-5-2A*	3	-02	3.2	1/8	5/16 - 32 UNF	28	11	11	103.4	15,000
6ZEPL-5-2A*	3	-02	3.2	1/8	5/16 - 24 UNF	33	18	11	103.4	15,000
63ZPL-5-3*	5	-03	4.8	3/16	5/16 - 32 UNF	33	13	13	103.4	15,000
63ZPL-5-3C*	5	-03	4.8	3/16	5/16 - 32 UNF	34	9	14	103.4	15,000
63ZPL-5-4C*	6	-04	6.4	1/4	5/16 - 32 UNF	71	11	17	100.0	14,500

6EZPL – Male water jetting nozzle

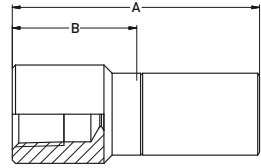

MATERIAL Carbon steel zinc plated

NOTE * ProLance fitting

#	⊙				⋈	A	B	R	⊙	
	DN	size	mm	inch		mm	mm	mm	MPa	psi
6EZPL-5-2A*	3	-02	3.2	1/8	5/16 - 24 UNF	38	23	11	103.4	15,000
6EZPL-1-2A*	3	-02	3.2	1/8	#12 - 28 UNF	33	17	11	103.4	15,000

1YZTX – Metric male nozzle nipple

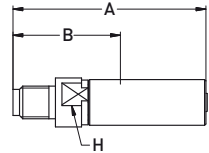

MATERIAL Carbon steel zinc plated

#	⊙				⋈	A	B	H	⊙	
	DN	size	mm	inch		mm	mm	mm	MPa	psi
1YZTX-1-02WS	3	-02	3.0	1/8	M5	49	28	6	110	15,950
1YZTX-2-02W	3	-02	3.0	1/8	M7	49	28	7	110	15,950
1YZTX-1-025W	4	-025	4.0	5/32	M5	51	29	8	110	15,950
1YZTX-2-025W	4	-025	4.0	5/32	M7	51	29	8	120	17,400
1YZTX-4-025W	4	-025	4.0	5/32	M8	53	30	8	120	17,400
1YZTX-5-025W	4	-025	4.0	5/32	M10x1	52	30	8	120	17,400
1YZTX-2-03W	5	-03	4.8	3/16	M7	55	28	10	100	14,500
1YZTX-4-03W	5	-03	4.8	3/16	M8	53	28	10	100	14,500
1YZTX-5-04W	6	-04	6.4	1/4	M10x1	59	33	13	110	15,950
1YZTX-5-05W	8	-05	7.9	5/16	M10x1	68	34	13	90	13,050

1YBTX – BSP male nozzle nipple

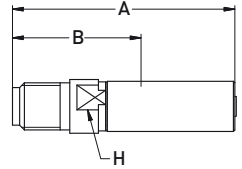

MATERIAL Carbon steel zinc plated

#	⊙				⌚	A	B	⊠	↗	
	DN	size	mm	inch					mm	MPa
1YBTX-2-025W	4	-025	4.0	5/32	G 1/8	53	30	8	120	17,400
1YBTX-4-025W	4	-025	4.0	5/32	G 1/4	54	30	10	120	17,400
1YBTX-2-03W	5	-03	4.8	3/16	G 1/8	53	27	10	100	14,500
1YBTX-4-03W	5	-03	4.8	3/16	G 1/4	58	31	10	100	14,500
1YBTX-2-04W	6	-04	6.4	1/4	G 1/8	60	33	10	110	15,950
1YBTX-4-04W	6	-04	6.4	1/4	G 1/4	62	36	10	110	15,950
1YBTX-4-05W	8	-05	7.9	5/16	G 1/4	68	35	13	90	13,050
1YBTX-6-05W	8	-05	7.9	5/16	G 3/8	71	37	17	90	13,050

Tube cleaning

Chapter D

High pressure hose & fittings

Hose

2244N – High pressure hose..... D-5

Related fittings for water jetting applications

1C9KX – Metric female swivel heavy series with O-ring D-6
192KX – BSP female swivel (60° cone)..... D-6
6AY8X – Type “M” female swivel D-7
1AYKX – Type “M” female swivel D-7
6018X – NPT male D-7

Related fittings for hydraulic applications

1C38X – Metric female swivel light series..... D-8
1C68X – Metric female swivel heavy series D-9
1C98X – Metric female swivel heavy series with O-ring D-9
1C9NX – Metric female swivel heavy series with O-ring D-9
10C8X – Metric female swivel heavy series with O-ring, 45° elbow . D-10
11C8X – Metric female swivel heavy series with O-ring, 90° elbow . D-10
1D28X – Metric male heavy series..... D-11
1928X – BSP female swivel (60° cone)..... D-11
1U08X – BSP female swivel (ballnose)..... D-12
13B8X – BSP male..... D-13
13BNX – BSP male..... D-13
1018X – NPT male..... D-13
1038X – JIC male..... D-14
103NX – JIC male..... D-14
1068X – JIC female swivel..... D-14
6068X – JIC female swivel..... D-14
106NX – JIC female swivel..... D-14
107NX – NPSM female swivel..... D-15
1AY8X – Type “M” female swivel D-16
1158X – SAE code 61 flange D-16
115NX – SAE code 61 flange D-16
1178X – SAE code 61 flange 45° elbow D-17
117NX – SAE code 61 flange 45° elbow D-17
1198X – SAE code 61 flange 90° elbow D-17

High pressure

119NX – SAE code 61 flange 90° elbow	D-17
16A8X – SAE code 62 flange	D-18
16ANX – SAE code 62 flange	D-18
16F8X – SAE code 62 flange 45° elbow	D-18
16FNX – SAE code 62 flange 45° elbow	D-18
16N8X – SAE code 62 flange 90° elbow	D-19
16NNX – SAE code 62 flange 90° elbow	D-19

Hose

2022N – High pressure hose – electrically non-conductive.....	D-20
--	------

Related fittings for hydraulic applications

10655 – JIC female swivel.....	D-21
1068X – JIC female swivel.....	D-21
1063X – JIC female swivel.....	D-21
106LX – JIC female swivel.....	D-21
19255 – BSP female swivel (60° cone).....	D-22
1928X – BSP female swivel (60° cone).....	D-22
1923X – BSP female swivel (60° cone).....	D-22
1C955 – Metric female swivel heavy series	D-23
1C98X – Metric female swivel heavy series	D-23
1C93X – Metric female swivel heavy series	D-23
1C9LX – Metric female swivel heavy series	D-23

Hose

2340N – High pressure hydraulic hose	D-24
---	------

Related fittings for hydraulic applications

1C98X – Metric female swivel heavy series	D-25
1928X – BSP female swivel (60° cone).....	D-25
1U08X – BSP female swivel (ballnose).....	D-26
1D98X – BSP male.....	D-27
13B8X – BSP male.....	D-27
1018X – NPT male.....	D-28
1058X – UNF male with O-ring.....	D-28
1068X – JIC female swivel.....	D-29
1AY8X – Type “M” female swivel	D-29
1078X – NPSM female swivel.....	D-30

Hose

2380N/2380M – High pressure hose	D-31
2380N-MSHA – High pressure mining hose	D-32

Related fittings for water jetting applications

1C9KX – Metric female swivel heavy series with O-ring	D-33
192KX – BSP female swivel (60° cone).....	D-33
1AYKX – Type “M” female swivel	D-34

Related fittings for hydraulic and mining applications

1AY8X – Type “M” female swivel	D-34
1018X – National Pipe Tapered (NPT) male.....	D-35
601LX – National Pipe Tapered (NPT) male.....	D-35
1068X – JIC female swivel.....	D-36
606LX – JIC female swivel.....	D-36
1928X – BSP female swivel	D-36
192LX – BSP female swivel	D-36
1D98X – BSP male	D-37
1078X – NPSM female swivel.....	D-37
1U08X – BSP female swivel (ballnose).....	D-38
13B8X – BSP male	D-38
13BNX – BSP male.....	D-38
1C98X – Metric female swivel heavy series	D-39
1C9LX – Metric female swivel heavy series	D-39
1C9NX – Metric female swivel heavy series	D-39
1928X – BSP female swivel (60° cone).....	D-39
192LX – BSP female swivel (60° cone).....	D-39

Hose

2388N – High pressure hose.....	D-40
--	------

Related fittings for water jetting applications

101BS – National Pipe Tapered (NPT) male.....	D-41
192BS – BSP female swivel (60° cone).....	D-42
1D9BS – BSP male.....	D-43
65Y8X – Medium pressure female swivel	D-43
1C9BS – Metric female swivel heavy series with O-ring	D-44
1AYBS – Type “M” female swivel	D-45

Related fittings for hydraulic applications

1AY8X – Type “M” female swivel D-45
1018X – National Pipe Tapered (NPT) male..... D-46
1068X – JIC female swivel..... D-46
1928X – BSP female swivel D-47
1D98X – BSP male..... D-47
1MB8X – Male Stecko..... D-48
1C38X – Metric female swivel light series..... D-48
1058X – UNF male with O-ring..... D-49
1078X – NPSM female swivel..... D-49
1U08X – BSP female swivel (ballnose)..... D-50
13B8X – BSP male..... D-50
1C98X – Metric female swivel heavy series D-51
1928X – BSP female swivel (60° cone)..... D-51

Hose

2580N – High pressure water jetting hose..... D-52
2580N-MSHA – High pressure mining hose..... D-53

Related fittings

101BL – National Pipe Tapered (NPT) male..... D-54
192BL – BSP female swivel (60° cone)..... D-55
1C9BL – Metric female swivel heavy series with O-ring D-56
1AYBL – Type “M” female swivel D-57

High pressure

2244N – High pressure hose



APPLICATIONS

- High pressure service for the construction and shipbuilding industries and for general industrial cleaning applications.
- Mainly used to remove different kinds of dirt accumulation, or materials from various surfaces, such as those in tanks, from concrete, asphalt, etc.







CONSTRUCTION

Core tube : Polyamide
 Pressure reinforcement : Two spiral layers, one braided layer of high tensile steel wire
 Cover : Polyurethane, DN32: Polyamide
 Colour : Black







TEMPERATURE RANGE

-10°C up to +70°C for water jetting applications
 -40°C up to +100°C for hydraulic applications

Water jetting applications

#													
	DN	size	mm	inch	mm	MPa	psi	MPa	psi	mm	kg/m		
2244N-06V10W	10	-06	9.7	3/8	18.0	86	12,470	215	31,175	120	0.50		
2244N-08V10W	12	-08	12.8	1/2	22.7	88	12,760	220	31,900	150	0.80		

Hydraulic applications

#													
	DN	size	mm	inch	mm	MPa	psi	MPa	psi	mm	kg/m		
2244N-025V00	4	-025	3.9	5/32	9.6	75.0	10,875	300	43,500	55	0.19		
2244N-06V00	10	-06	9.8	3/8	18.0	53.5	7,755	215	31,175	120	0.50		
2244N-08V10	12	-08	12.9	1/2	22.7	55.0	7,975	220	31,900	150	0.80		
2244N-20V30	32	-20	31.8	1 1/4	44.0	27.5	3,990	110	15,950	400	1.83		

NOTES -

1C9KX – Metric female swivel heavy series with O-ring

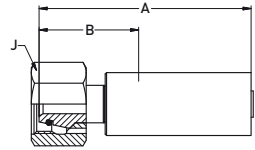

MATERIAL → Special materials

#	⊙				⌚	A	B	J	⤴	
	DN	size	mm	inch		mm	mm	mm	MPa	psi
1C9KX-14-06W	10	-06	9.5	3/8	M22x1.5	79	37	27	86	12,470
1C9KX-16-08W	12	-08	12.7	1/2	M24x1.5	88	41	30	88	12,760

Fittings for water jetting applications

192KX – BSP female swivel (60° cone)

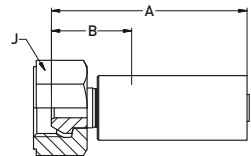

MATERIAL → Special materials

#	⊙				⌚	A	B	J	⤴	
	DN	size	mm	inch		mm	mm	mm	MPa	psi
192KX-6-06W	10	-06	9.5	3/8	G3/8	72	29	22	86	12,470
192KX-8-08W	12	-08	12.7	1/2	G1/2	81	33	27	88	12,760

Fittings for water jetting applications

6AY8X / 1AYKX – Type “M” female swivel

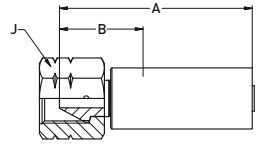

MATERIAL Special materials

#	⊙				📏	A	B	J	↗	
	DN	size	mm	inch					MPa	psi
6AY8X-6-2AC	4	-025	4	5/32	9/16 - 18	59	31	17	120	17,400
1AYKX-8-06W	10	-06	9.5	3/8	3/4 - 16UNF	74	32	27	86	12,470
1AYKX-11-08W	12	-08	12.7	1/2	1 - 12UNF	82	34	32	88	12,760

Fittings for water jetting applications

High pressure

6018X – NPT male

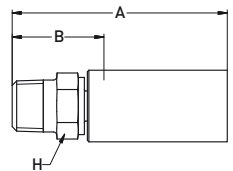

MATERIAL Special materials

#	⊙				📏	A	B	H	↗	
	DN	size	mm	inch					MPa	psi
6018X-2-2A	4	-025	4	5/32	1/8 NPT	57	19	16	103	15,000
6018X-2-2AC	4	-025	4	5/32	1/8 NPT	55	46	13	103	15,000
6018X-4-2AC	4	-025	4	5/32	1/4 NPT	62	34	16	103	15,000

Fittings for water jetting applications

1C38X – Metric female swivel light series

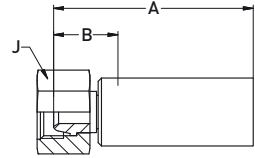

MATERIAL Carbon steel, zinc plated

#	⊙				📏	A	B	J	⊙	
	DN	size	mm	inch					MPa	psi
1C38X-10-06	10	-06	9.5	3/8	M16x1.5	49	20	22	53.5	7,755
1C38X-12-06	10	-06	9.5	3/8	M18x1.5	48	19	22	53.5	7,755
1C38X-12-08	12	-08	12.7	1/2	M18x1.5	52	20	24	55.0	7,975
1C38X-15-08	12	-08	12.7	1/2	M22x1.5	51	20	27	55.0	7,975

Fittings for hydraulic applications

1C38X – Metric female swivel light series With stainless steel nipple

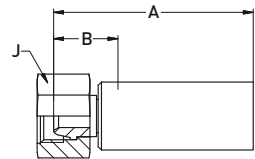

MATERIAL Carbon steel, zinc plated (shell and nut)
stainless steel nipple (material 1.4301)

#	⊙				📏	A	B	H	⊙	
	DN	size	mm	inch					MPa	psi
1C38X-10-06C2W	10	-06	9.5	3/8	M16x1.5	49	20	22	53.5	7,755
1C38X-12-06C2W	10	-06	9.5	3/8	M18x1.5	48	19	22	53.5	7,755
1C38X-12-08C2W	12	-08	12.7	1/2	M18x1.5	52	20	24	55.0	7,975
1C38X-15-08C2W	12	-08	12.7	1/2	M22x1.5	51	20	27	55.0	7,975

Fittings for hydraulic applications

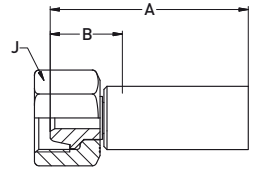
1C68X – Metric female swivel heavy series**MATERIAL** Carbon steel, zinc plated

#	⊙				⌚	A	B	J	↗	
	DN	size	mm	inch					MPa	psi
1C68X-14-06	10	-06	9.5	3/8	M22x1.5	64	24	27	53.5	7,755
1C68X-16-08	12	-08	12.7	1/2	M24x1.5	67	24	30	55.0	7,975

Fittings for hydraulic applications**1C98X / 1C9NX – Metric female swivel heavy series with O-ring**

ISO 12151-2

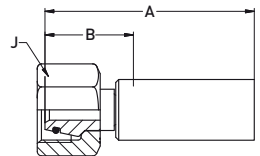
MATERIAL Carbon steel, zinc plated

#	⊙				⌚	A	B	J	↗	
	DN	size	mm	inch					MPa	psi
1C98X-8-025	4	-025	4	5/32	M16x1.5	54	27	19	75.0	10,875
1C98X-12-06	10	-06	9.5	3/8	M20x1.5	70	30	24	53.5	7,755
1C98X-14-06	10	-06	9.5	3/8	M22x1.5	71	30	27	53.5	7,755
1C98X-16-08	12	-08	12.7	1/2	M24x1.5	78	35	30	55.0	7,974
1C9NX-38-20	32	-20	31.8	1 1/4	M52x2	113	52	60	44.0	6,380

Fittings for hydraulic applications

10C8X – Metric female swivel heavy series with O-ring, 45° elbow

ISO 12151-2

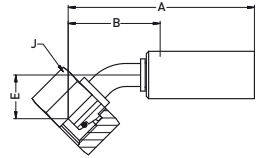

MATERIAL Carbon steel, zinc plated

#	⊙				📏	A	B	E	J	⌚	
	DN	size	mm	inch						MPa	psi
10C8X-12-06	10	-06	9.5	3/8	M20x1.5	81	40	19	24	53.5	7,755
10C8X-14-06	10	-06	9.5	3/8	M22x1.5	81	40	19	27	53.5	7,755
10C8X-16-08	12	-08	12.7	1/2	M24x1.5	96	53	23	30	55.0	7,975

Fittings for hydraulic applications

11C8X – Metric female swivel heavy series with O-ring, 90° elbow

ISO 12151-2

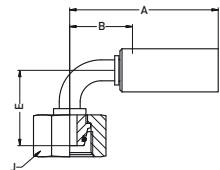



MATERIAL Carbon steel, zinc plated

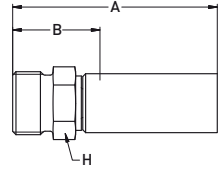

#	⊙				📏	A	B	E	J	⌚	
	DN	size	mm	inch						MPa	psi
11C8X-14-06	10	-06	9.5	3/8	M22x1.5	71	30	36	27	53.5	7,755
11C8X-16-08	12	-08	12.7	1/2	M24x1.5	85	42	44	30	55.0	7,975

Fittings for hydraulic applications

1D28X – Metric male heavy series
ISO 12151-2**MATERIAL** Carbon steel, zinc plated

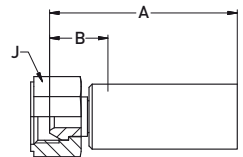
#	⊙					A	B	H		
	DN	size	mm	inch		mm	mm	mm	MPa	psi
1D28X-14-06	10	-06	9.5	3/8	M22x1.5	71	31	22	53.5	7,755
1D28X-16-08	12	-08	12.7	1/2	M24x1.5	74	31	24	55.0	7,975

Fittings for hydraulic applications**1928X – BSP female swivel (60° cone)****MATERIAL** Carbon steel, zinc plated

#	⊙					A	B	J		
	DN	size	mm	inch		mm	mm	mm	MPa	psi
1928X-4-025	4	-025	4	5/32	G 1/4	48	20	19	75.0	10,875
1928X-6-06	10	-06	9.5	3/8	G 3/8	59	19	22	53.5	7,755
1928X-8-06	10	-06	9.5	3/8	G 1/2	60	20	27	53.5	7,755
1928X-8-08	12	-08	12.7	1/2	G 1/2	63	20	27	55.0	7,975

Fittings for hydraulic applications

1U08X – BSP female swivel (ballnose)

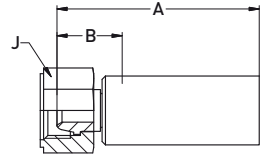

MATERIAL Carbon steel, zinc plated

#	⊙				⌚	A	B	J	⌚	
	DN	size	mm	inch					MPa	psi
1U08X-6-06	10	-06	9.5	3/8	G 3/8	61	20	22	53.5	7,755
1U08X-8-06	10	-06	9.5	3/8	G 1/2	61	20	27	53.5	7,755
1U08X-8-08	12	-08	12.7	1/2	G1/2	61	22	27	55.0	7,975

Fittings for hydraulic applications

1U08X – BSP female swivel (ballnose) With stainless steel nipple

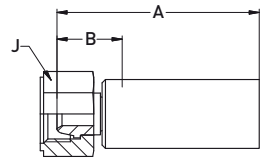

MATERIAL Carbon steel, zinc plated (shell and nut)
stainless steel nipple (material 1.4301)

#	⊙				⌚	A	B	J	⌚	
	DN	size	mm	inch					MPa	psi
1U08X-6-06C2W	10	-06	9.5	3/8	G 3/8	61	20	22	53.5	7,755
1U08X-8-06C2W	10	-06	9.5	3/8	G 1/2	61	20	27	53.5	7,755
1U08X-8-08C2W	12	-08	12.7	1/2	G1/2	61	22	27	55.0	7,975

Fittings for hydraulic applications

13B8X / 13BNX – BSP male

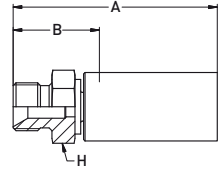

MATERIAL Carbon steel, zinc plated

#	⊙				⌚	A	B	H	↗	
	DN	size	mm	inch					MPa	psi
13B8X-4-025	4	-025	4	5/32	G 1/4	57	30	17	75.0	10,875
13B8X-6-06	10	-06	9.5	3/8	G 3/8	71	30	22	53.5	7,755
13B8X-8-06	10	-06	9.5	3/8	G 1/2	76	35	22	53.5	7,755
13B8X-8-08	12	-08	12.7	1/2	G 1/2	79	35	24	55.0	7,974
13BNX-24-20	32	-20	31.8	1 1/4	G 1 1/2	118	57	55	44.0	6,380

Fittings for hydraulic applications

High pressure

1018X – NPT male

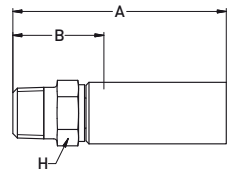

MATERIAL Carbon steel, zinc plated

#	⊙				⌚	A	B	H	↗	
	DN	size	mm	inch					MPa	psi
1018X-2-025	4	-025	4	5/32	1/8 - 27NPTF	51	24	8	75.0	10,875
1018X-4-025	4	-025	4	5/32	1/4 - 18NPTF	59	32	13	75.0	10,875
1018X-6-06	10	-06	9.5	3/8	3/8 - 18NPTF	71	31	19	53.5	7,755
1018X-8-06	10	-06	9.5	3/8	1/2 - 14NPTF	76	36	22	53.5	7,755
1018X-8-08	12	-08	12.7	1/2	1/2 - 14NPTF	79	37	22	55.0	7,975

Fittings for hydraulic applications

1038X / 103NX – JIC male

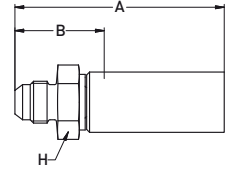

MATERIAL Carbon steel, zinc plated

#	⊙				⌚	A	B	H	⊙	
	DN	size	mm	inch					MPa	psi
1038X-8-06	10	-06	9.5	3/8	3/4 - 16UNF	74	34	22	53.5	7,755
1038X-10-08	12	-08	12.7	1/2	7/8 - 14UNF	83	40	24	55.0	7,974
103NX-24-20	32	-20	31.8	1 1/4	1 7/8 - 12UNF	110	49	50	44.0	6,380

Fittings for hydraulic applications

1068X / 6068X / 106NX – JIC female swivel

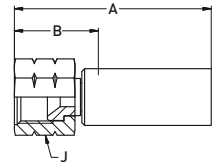

MATERIAL Carbon steel, zinc plated

#	⊙				⌚	A	B	J	⊙	
	DN	size	mm	inch					MPa	psi
6068X-4-2AC	4	-025	4	5/32	7/16 - 20 UNF	55	27	14	69	10,000
1068X-6-06	10	-06	9.5	3/8	9/16 - 18 UNF	59	18	22	69	10,000
1068X-8-06	10	-06	9.5	3/8	3/4 - 16 UNF	59	19	24	69	10,000
6068X-8-8C	12	-08	12.8	1/2	3/4 - 16 UNF	79	33	22	69	10,000
1068X-8-08	12	-08	12.7	1/2	3/4 - 16 UNF	64	21	27	69	10,000
1068X-10-08	12	-08	12.7	1/2	7/8 - 14 UNF	62	19	27	69	10,000
106NX-20-20	32	-20	31.8	1 1/4	1 5/8 - 12 UNF	104	44	50	44	6,380

Fittings for hydraulic applications

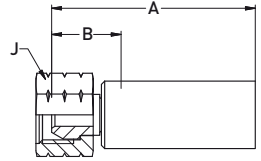
1078X – NPSM female swivel**MATERIAL** Carbon steel, zinc plated

#	⊙				📏	A	B	J	↗	
	DN	size	mm	inch					MPa	psi
1078X-6-06	10	-06	9.5	3/8	3/8 - 18NPSM	50	21	22	53.5	7,755
1078X-8-08	12	-08	12.7	1/2	1/2 - 14NPSM	50	19	27	55.0	7,975

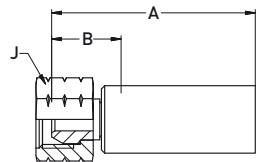
Fittings for hydraulic applications**1078X – NPSM female swivel**
With stainless steel nipple**MATERIAL** Carbon steel, zinc plated
stainless steel nipple (material 1.4301)

#	⊙				📏	A	B	J	↗	
	DN	size	mm	inch					MPa	psi
1078X-6-06C2W	10	-06	9.5	3/8	3/8 - 18NPSM	50	21	22	53.5	7,755
1078X-8-08C2W	12	-08	12.7	1/2	1/2 - 14NPSM	50	19	27	55.0	7,975

Fittings for hydraulic applications

1AY8X – Type “M” female swivel

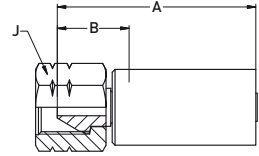

MATERIAL Carbon steel, zinc plated

#						A	B			
	DN	size	mm	inch		mm	mm	mm	MPa	psi
1AY8X-6-025	4	-025	4	5/32	9/16 - 18 UNF	56	28	19	75	10,870

Fittings for hydraulic applications

1158X / 115NX – SAE code 61 flange ISO 12151-3

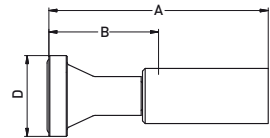

MATERIAL Carbon steel, zinc plated

#					A	B	D		
	DN	size	mm	inch	mm	mm	mm	MPa	psi
1158X-8-08	12	-08	12.7	1/2	87	44	30	21	3,000
115NX-20-20	32	-20	31.8	1 1/4	117	56	51	21	3,000

Fittings for hydraulic applications

1178X / 117NX – SAE code 61 flange 45° elbow
 ISO 12151-3

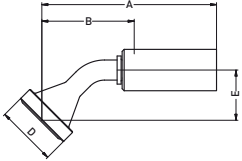

MATERIAL Carbon steel, zinc plated

#	⊙				A	B	D	E	⊙	
	DN	size	mm	inch					MPa	psi
1178X-8-08	12	-08	12.7	1/2	95	53	30	20	55.0	7,974
117NX-20-20	32	-20	31.8	1 1/4	174	113	51	37	44.0	6,380

Fittings for hydraulic applications

High pressure

1198X / 119NX – SAE code 61 flange 90° elbow
 ISO 12151-3

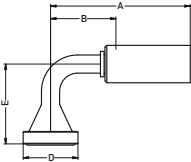

MATERIAL Carbon steel, zinc plated

#	⊙				A	B	D	E	⊙	
	DN	size	mm	inch					MPa	psi
1198X-8-08	12	-08	12.7	1/2	78	35	30	44	55.0	7,974
119NX-20-20	32	-20	31.8	1 1/4	165	104	51	82	44.0	6,380

Fittings for hydraulic applications

16A8X / 16ANX – SAE code 62 flange ISO 12151-3

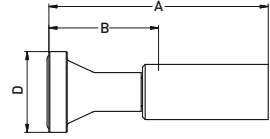

MATERIAL Carbon steel, zinc plated

#	⊙				A	B	D	↻	
	DN	size	mm	inch	mm	mm	mm	MPa	psi
16A8X-8-08	12	-08	12.7	1/2	88	45	32	55.0	7,974
16ANX-20-20	32	-20	31.8	1 1/4	126	65	54	44.0	6,380

Fittings for hydraulic applications

16F8X / 16FNX – SAE code 62 flange 45° elbow

ISO 12151-3

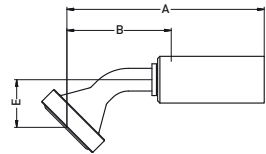

MATERIAL Carbon steel, zinc plated

#	⊙				A	B	D	E	↻	
	DN	size	mm	inch	mm	mm	mm	mm	MPa	psi
16F8X-8-08	12	-08	12.7	1/2	95	52	32	21	55.0	7,974
16FNX-20-20	32	-20	31.8	1 1/4	180	119	54	44	44.0	6,380

Fittings for hydraulic applications

High pressure

**16N8X / 16NNX – SAE code 62 flange
90° elbow**

ISO 12151-3

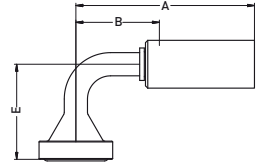
MATERIAL Carbon steel, zinc plated

#	⊙				A	B	D	E	⊙	
	DN	size	mm	inch					MPa	psi
16N8X-8-08	12	-08	12.7	1/2	87	44	31	41	55.0	7,974
16NNX-20-20	32	-20	31.8	1 1/4	165	104	54	91	44.0	6,380

Fittings for hydraulic applications

2022N – High pressure hose electrically non-conductive









APPLICATIONS • High pressure applications where non-conductivity is required

CONSTRUCTION Core tube : Polyamide 11, methanol washed
Pressure reinforcement : Two braided layers of high tensile aramid fibre

Cover : Sea water resistant TPU
Colour : Orange

TEMPERATURE RANGE -40°C up to +80°C

Hydraulic applications

#												
	DN	size	mm	inch	mm	MPa	psi	MPa	psi	mm	kg/m	
2022N-04V15-5K	6	-04	6.4	1/4	12.7	34.5	5,000	138	20,000	51	0.12	
2022N-06V15-5K	10	-06	9.7	3/8	16.1	34.5	5,000	138	20,000	76	0.15	
2022N-08V15-5K	12	-08	12.9	1/2	20.8	34.5	5,000	138	20,000	102	0.17	
2022N-04V15-10K	6	-04	6.4	1/4	13.8	69.0	10,000	276	40,000	100	0.14	
2022N-06V15-10K	10	-06	9.7	3/8	19.0	69.0	10,000	276	40,000	100	0.24	
2022N-08V15-10K	12	-08	12.9	1/2	23.0	69.0	10,000	276	40,000	100	0.34	

NOTES

10655 – JIC female swivel

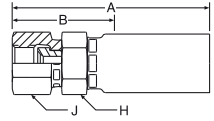

MATERIAL Stainless steel (AISI 316), other materials on request.

#	⊙				📏	A	B	H	J	⤵	
	DN	size	mm	inch						MPa	psi
10655-4-4C	6	-04	6.4	1/4	7/16 - 20 UNF	65	33	17	17	34.5	5,000
10655-6-6C	10	-06	9.5	3/8	9/16 - 18 UNF	69	33	19	19	34.5	5,000
10655-8-8C	12	-08	12.7	1/2	3/4 - 16 UNF	79	38	22	22	34.5	5,000

Fittings for -5K hoses

1068X / 1063X / 106LX – JIC female swivel

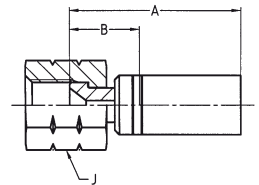

MATERIAL Stainless steel (AISI 316), other materials on request.

#	⊙				📏	A	B	J	⤵	
	DN	size	mm	inch					MPa	psi
1068X-6-04C	6	-04	6.4	1/4	9/16 - 18 UNF	55	24	19	69.0	10,000
1063X-6-06C	10	-06	9.5	3/8	9/16 - 18 UNF	69	33	22	69.0	10,000
106LX-8-08C	12	-08	12.7	1/2	3/4 - 16 UNF	85	41	24	69.0	10,000

Fittings for -10K hoses

19255 – BSP female swivel (60° cone)

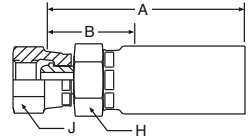

MATERIAL Stainless steel (AISI 316), other materials on request.

#	⊙				⌚	A	B	H	J	⌚	
	DN	size	mm	inch						MPa	psi
19255-4-4C	6	-04	6.4	1/4	G 1/4	58	26	17	19	34.5	5,000
19255-6-6C	10	-06	9.5	3/8	G 3/8	64	27	19	22	34.5	5,000
19255-8-8C	12	-08	12.7	1/2	G 5/8	73	32	24	27	34.5	5,000

Fittings for -5K hoses

1928X / 1923X – BSP female swivel (60° cone)

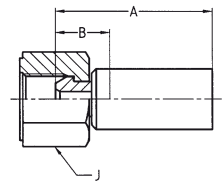

MATERIAL Stainless steel (AISI 316), other materials on request.

#	⊙				⌚	A	B	J	⌚	
	DN	size	mm	inch					MPa	psi
1928X-6-04C	6	-04	6.4	1/4	G 1/4	56	25	19	69.0	10,000
1923X-8-06C	10	-06	9.5	3/8	G 1/2	66	22	30	69.0	10,000

Fittings for -10K hoses

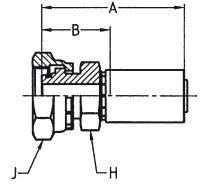
1C955 – Metric female swivel
Heavy series**MATERIAL** Stainless steel (AISI 316), other materials on request.

#	⊙				⌚	A	B	H	J	⌚	
	DN	size	mm	inch						MPa	psi
1C955-8-4C	6	-04	6.4	1/4	M16 x 1.5	70	38	17	19	34.5	5,000
1C955-10-4C	6	-04	6.4	1/4	M18 x 1.5	67	36	19	22	34.5	5,000
1C955-12-4C	6	-04	6.4	1/4	M20 x 1.5	64	32	19	24	34.5	5,000
1C955-12-6C	10	-06	9.5	3/8	M20 x 1.5	68	32	19	24	34.5	5,000
1C955-16-8C	12	-08	12.7	1/2	M24 x 1.5	77	36	24	30	34.5	5,000

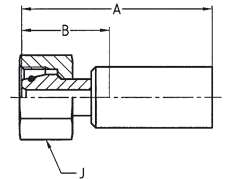
Fittings for -5K hoses**1C98X / 1C93X / 1C9LX – Metric female swivel**
Heavy series**MATERIAL** Stainless steel (AISI 316), other materials on request.

#	⊙				⌚	A	B	J	⌚	
	DN	size	mm	inch					MPa	psi
1C98X-8-04C	6	-04	6.4	1/4	M16 x 1.5	59	27	19	69.0	10,000
1C98X-10-04C	6	-04	6.4	1/4	M18 x 1.5	65	33	22	69.0	10,000
1C93X-14-06C	10	-06	9.5	3/8	M22 x 1.5	75	30	30	69.0	10,000
1C93X-16-06C	10	-06	9.5	3/8	M24 x 1.5	88	34	30	69.0	10,000
1C9LX-16-08C	12	-08	12.7	1/2	M24 x 1.5	88	34	32	69.0	10,000

Fittings for -10K hoses

2340N – High pressure hydraulic hose



APPLICATIONS

- High pressure service for use with petroleum or synthetic hydraulic fluids. High kink resistance and high flexibility for hydraulic tools, straightening benches, clamps.

CONSTRUCTION

Core tube : Polyamide
Pressure reinforcement : Two spiral layers and two open spiral layers of high tensile steel wire
Cover : Polyurethane
Colour : Black

TEMPERATURE RANGE

-40°C up to +100°C

Hydraulic applications

#	Ø				Ø		↗		✂		↘		kg/m
	DN	size	mm	inch	mm	MPa	psi	MPa	psi	mm			
2340N-04V10	6	-04	6.4	1/4	12.5	72	10,440	288	41,760	70	0.25		

NOTES

**1C98X – Metric female swivel heavy series
 with O-ring**

ISO 12151-2

MATERIAL Carbon steel, zinc plated

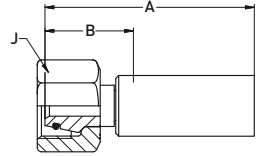

#	⊙				🌀	A	B	J	↗	
	DN	size	mm	inch					MPa	psi
1C98X-8-04	6	-04	6.4	1/4	M16x1.5	59	27	19	80	11,600
1C98X-10-04	6	-04	6.4	1/4	M18x1.5	56	33	22	80	11,600

High pressure

1928X – BSP female swivel (60° cone)

MATERIAL Carbon steel, zinc plated

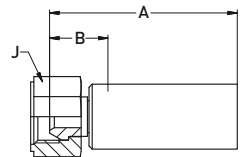

#	⊙				🌀	A	B	J	↗	
	DN	size	mm	inch					MPa	psi
1928X-4-04	6	-04	6.4	1/4	G 1/4	56	25	19	80	11,600

1U08X – BSP female swivel (ballnose)

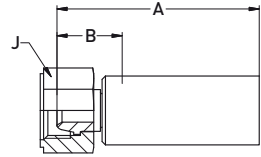

MATERIAL Carbon steel, zinc plated

#	⊙				⌚	A	B	J	⊙	
	DN	size	mm	inch		mm	mm	mm	MPa	psi
1U08X-4-04	6	-04	6.4	1/4	G 1/4	58	27	19	80	11,600
1U08X-6-04	6	-04	6.4	1/4	G 3/8	58	27	27	80	11,600

1U08X – BSP female swivel (ballnose) With stainless steel nipple

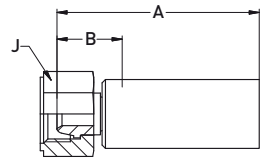

MATERIAL Carbon steel, zinc plated (shell and nut)
stainless steel nipple (material 1.4301)

#	⊙				⌚	A	B	J	⊙	
	DN	size	mm	inch		mm	mm	mm	MPa	psi
1U08X-4-04C2W	6	-04	6.4	1/4	G 1/4	58	27	19	80	11,600
1U08X-6-04C2W	6	-04	6.4	1/4	G 3/8	58	27	27	80	11,600

1D98X – BSP male

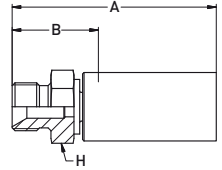

MATERIAL Carbon steel, zinc plated

#	⊙				⌚	A	B	H	↗	
	DN	size	mm	inch		mm	mm	mm	MPa	psi
1D98X-4-04	6	-04	6.4	1/4	G 1/4	67	35	19	80	11,600

High pressure

13B8X – BSP male

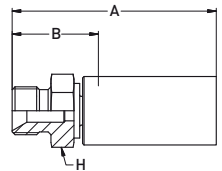

MATERIAL Carbon steel, zinc plated

#	⊙				⌚	A	B	H	↗	
	DN	size	mm	inch		mm	mm	mm	MPa	psi
13B8X-4-04	6	-04	6.4	1/4	G 1/4	64	32	17	80	11,600
13B8X-6-04	6	-04	6.4	1/4	G 3/8	67	35	19	80	11,600

1018X – NPT male

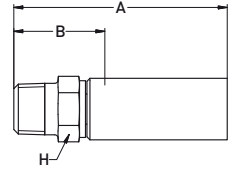

MATERIAL Carbon steel, zinc plated

#	⊙				⌚	A	B	H	↻	
	DN	size	mm	inch		mm	mm	mm	MPa	psi
1018X-4-04	6	-04	6.4	1/4	1/4 - 18NPTF	65	33	14	80	11,600
1018X-6-04	6	-04	6.4	1/4	3/8 - 18NPTF	67	35	19	80	11,600

1058X – UNF male with O-ring

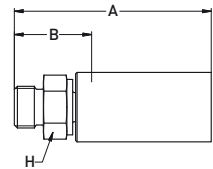

MATERIAL Special materials

#	⊙				⌚	A	B	H	↻	
	DN	size	mm	inch		mm	mm	mm	MPa	psi
1058X-4-04	6	-04	6.4	1/4	7/16 - 20 UNF	61	29	14	80	11,600
1058X-6-04	6	-04	6.4	1/4	9/16 - 18 UNF	62	30	17	80	11,600

1068X – JIC female swivel

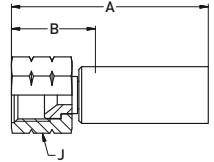

MATERIAL Carbon steel, zinc plated

#						A	B			
	DN	size	mm	inch					mm	mm
1068X-4-04	6	-04	6.4	1/4	7/16 - 20 UNF	57	26	19	80	11,600
1068X-5-04	6	-04	6.4	1/4	1/2 - 20 UNF	55	24	19	80	11,600
1068X-6-04	6	-04	6.4	1/4	9/16 - 18 UNF	55	24	19	80	11,600

High pressure

1AY8X – Type “M” female swivel

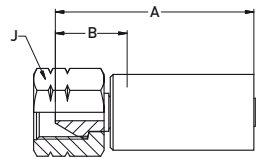

MATERIAL Carbon steel, zinc plated

#						A	B			
	DN	size	mm	inch					mm	mm
1AY8X-6-04	6	-04	6.4	1/4	9/16 - 18 UNF	60	28	19	80	11,600

1078X – NPSM female swivel

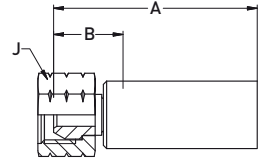

MATERIAL Carbon steel, zinc plated

#	⊙				⌚	A	B	J	⌚	
	DN	size	mm	inch		mm	mm	mm	MPa	psi
1078X-4-04	6	-04	6.4	1/4	1/4 - 18NPSM	59	28	19	80	11,600

1078X – NPSM female swivel With stainless steel nipple

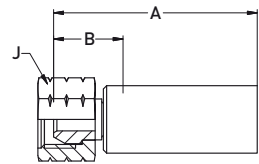

MATERIAL Carbon steel, zinc plated
stainless steel nipple (material 1.4301)

#	⊙				⌚	A	B	J	⌚	
	DN	size	mm	inch		mm	mm	mm	MPa	psi
1078X-4-04C2W	6	-04	6.4	1/4	1/4 - 18NPSM	59	28	19	80	11,600

High pressure

2380N / 2380M – High pressure hose



APPLICATIONS

- High pressure service for the construction and shipbuilding industries and for general industrial cleaning applications.
- Mainly used to remove different kinds of dirt accumulation, or materials from various surfaces, such as those in tanks, from concrete, asphalt, etc.







CONSTRUCTION

Core tube : Polyamide
Pressure reinforcement : Two spiral layers and two open spiral layers of high tensile steel wire
Cover : Polyurethane, DN32: Polyamide
Colour : Black







TEMPERATURE RANGE

-10°C up to +70°C for water jetting applications
 -40°C up to +100°C for hydraulic applications
2389M: -10°C up to +120°C for water jetting applications

Water jetting applications

#													
	DN	size	mm	inch	mm	MPa	psi	MPa	psi	mm	kg/m		
2380N-04V00W	6	-04	6.3	1/4	13.3	110	15,950	280	40,600	70	0.28		
2380N-05V00W	8	-05	8.3	5/16	15.8	100	14,500	250	36,250	90	0.35		
2380M-04V30W	6	-04	6.3	1/4	15.8	110	15,950	280	40,600	70	0.28		
2380M-05V30W	8	-05	8.3	5/16	15.8	100	14,500	250	36,250	90	0.35		

Hydraulic applications

#													
	DN	size	mm	inch	mm	MPa	psi	MPa	psi	mm	kg/m		
2380N-025V10	4	-025	3.9	5/32	9.7	75.0	10,875	300	43,500	55	0.16		
2380N-05V00	8	-05	8.3	5/16	15.8	62.5	9,060	250	36,250	90	0.35		
2380N-06V10	10	-06	9.8	3/8	17.9	57.5	8,337	230	33,350	120	0.44		
2380N-08V10	12	-08	12.9	1/2	22.9	55.0	7,975	220	31,900	150	0.68		
2380N-20V30	32	-20	31.8	1 1/4	44.0	27.5	3,985	110	15,950	400	1.83		

NOTES -

2380N-MSHA – High pressure mining hose









APPLICATIONS • Hydraulic applications in a mining environment

CONSTRUCTION

- Core tube** : Polyamide
- Pressure reinforcement** : Two spiral layers and two open spiral layers of high tensile steel wire
- Cover** : Polyurethane, MSHA approved
- Colour** : Black

TEMPERATURE RANGE -40°C up to +100°C

Mining applications

#												
	DN	size	mm	inch	mm	MPa	psi	MPa	psi	mm	kg/m	
2380N-04V10-MSHA	6	-04	6.3	1/4	13.3	70	10,150	280	40,600	70	0.28	

NOTES -

High pressure

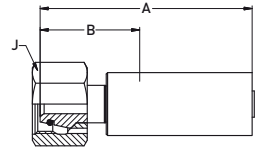
**1C9KX – Metric female swivel heavy series
with O-ring****MATERIAL** Carbon steel, zinc plated

#	⊙				🌀	A	B	J	↗	
	DN	size	mm	inch					MPa	psi
1C9KX-10-04W	6	-04	6.4	1/4	M18x1.5	68	36	22	110	15,950
1C9KX-16-05W	8	-05	7.9	5/16	M24x1.5	77	38	30	100	14,500

Fittings for water jetting applications

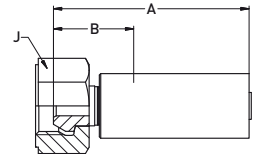
192KX – BSP female swivel (60° cone)**MATERIAL** Carbon steel, zinc plated

#	⊙				🌀	A	B	J	↗	
	DN	size	mm	inch					MPa	psi
192KX-4-04W	6	-04	6.4	1/4	G 1/4	56	25	19	110	15,950
192KX-6-05W	8	-05	7.9	5/16	G 3/8	64	25	27	100	14,500

Fittings for water jetting applications

1AYKX – Type “M” female swivel

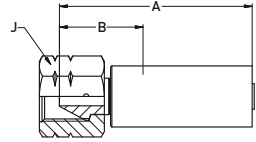

MATERIAL Carbon steel, zinc plated

#	⊙				⋈	A	B	J	↻	
	DN	size	mm	inch		mm	mm	mm	MPa	psi
1AYKX-6-04W	6	-04	6.4	1/4	9/16 - 18UNF	61	30	22	110	15,950
1AYKX-8-05W	8	-05	7.9	5/16	3/4 - 16UNF	70	31	27	100	14,500

Fittings for water jetting applications

1AY8X – Type “M” female swivel

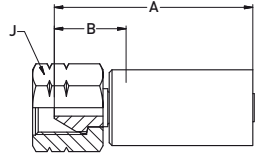

MATERIAL Carbon steel, zinc plated

#	⊙				⋈	A	B	J	↻	
	DN	size	mm	inch		mm	mm	mm	MPa	psi
1AY8X-6-04	6	-04	6.4	1/4	9/16 - 18 UNF	60	28	19	80.0	11,600
1AY8X-8-05	8	-05	7.9	5/16	3/4 - 16 UNF	74	30	27	62.5	9,060
1AY8X-8-06	10	-06	9.5	3/0	3/4 - 16 UNF	70	26	27	57.5	8,340

Fittings for hydraulic applications

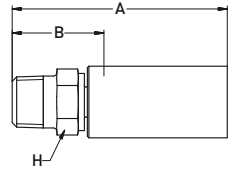
**1018X / 601LX – National Pipe Tapered (NPT)
male**

MATERIAL Carbon steel, zinc plated; ZE: Carbon steel, special plating for high corrosion protection in mining applications

#	⊙				⌚	A	B	⬡	↗	
	DN	size	mm	inch					MPa	psi
1018X-2-025	4	-025	4	5/32	1/8 - 27NPTF	51	24	8	75.0	10,890
1018X-4-025	4	-025	4	5/32	1/4 - 18NPTF	59	32	13	75.0	10,890
1018X-4-04	6	-04	6.4	1/4	1/4 - 18NPTF	65	33	14	80.0	11,600
1018X-4-04ZE	6	-04	6.4	1/4	1/4 - 18NPTF	65	33	14	80.0	11,600
1018X-6-04	6	-04	6.4	1/4	3/8 - 18NPTF	67	35	19	80.0	11,600
1018X-6-04ZE	6	-04	6.4	1/4	3/8 - 18NPTF	67	35	19	80.0	11,600
1018X-6-05	8	-05	7.9	5/16	3/8 - 18NPTF	70	30	19	93.8	13,600
601LX-4-5C	8	-05	7.9	5/16	1/4 NPT	71	30	16	93.8	13,600
601LX-4-5	8	-05	7.9	5/16	1/4 NPT	71	30	16	93.8	13,600
601LX-6-5C	8	-05	7.9	5/16	3/8 NPT	75	34	19	93.8	13,600
601LX-6-5	8	-05	7.9	5/16	3/8 NPT	75	34	19	93.8	13,600
1018X-6-06	10	-06	9.5	3/0	3/8 - 18NPTF	71	31	19	57.5	8,340
1018X-8-06	10	-06	9.5	3/0	1/2 - 14NPTF	76	36	22	57.5	8,340

Fittings for hydraulic applications

1068X / 606LX – JIC female swivel

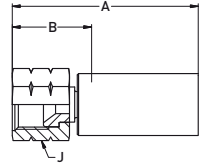

MATERIAL Carbon steel, zinc plated

#	⊙				📏	A	B	J	📏	
	DN	size	mm	inch					MPa	psi
1068X-4-04	6	-04	6.4	1/4	7/16 - 20 UNF	57	26	19	80.0	11,600
1068X-5-04	6	-04	6.4	1/4	1/2 - 20 UNF	55	24	19	80.0	11,600
1068X-6-04	6	-04	6.4	1/4	9/16 - 18 UNF	55	24	19	80.0	11,600
606LX-8-5C	8	-05	7.9	5/16	3/4 - 16 UNF	72	31	25	69.0	10,000
1068X-6-05	8	-05	7.9	5/16	9/16 - 18 UNF	56	16	19	62.5	9,060
1068X-8-05	8	-05	7.9	5/16	3/4 - 16 UNF	58	18	24	62.5	9,060

Fittings for hydraulic applications

1928X / 192LX – BSP female swivel (60° cone)

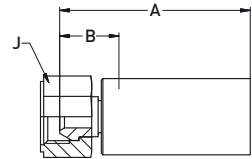

MATERIAL Carbon steel, zinc plated

#	⊙				📏	A	B	J	📏	
	DN	size	mm	inch					MPa	psi
1928X-4-025	4	-025	4	5/32	G 1/4	48	20	19	75.0	10,890
1928X-4-04	6	-04	6.4	1/4	G 1/4	56	25	19	80.0	11,600
1928X-6-06	10	-06	9.5	3/0	G 3/8	59	19	22	57.5	8,340
1928X-8-06	10	-06	9.5	3/0	G 1/2	60	20	27	57.5	8,340
192LX-8-08	12	-08	12.7	1/2	G 1/2	75	21	32	57.5	8,340

Fittings for hydraulic applications

1D98X – BSP male

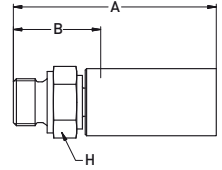
**MATERIAL** Carbon steel, zinc plated

#	⊙				⌚	A	B	H	↗	
	DN	size	mm	inch					MPa	psi
1D98X-4-04	6	-04	6.4	1/4	G 1/4	67	35	19	80.0	11,600
1D98X-6-05	8	-05	7.9	5/16	G 3/8	70	31	22	62.5	9,060

Fittings for hydraulic applications

1078X – NPSM female swivel

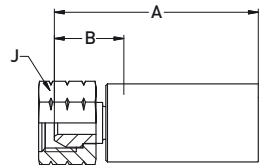
**MATERIAL** Carbon steel, zinc plated**NOTE** C2W: Stainless steel nipple

#	⊙				⌚	A	B	J	↗	
	DN	size	mm	inch					MPa	psi
1078X-4-04	6	-04	6.4	1/4	1/4 - 18NPSM	59	28	19	80.0	11,600
1078X-6-05	8	-05	7.9	5/16	3/8 - 18NPSM	60	21	22	62.5	9,060
1078X-6-06	10	-06	9.5	3/0	3/8 - 18NPSM	62	21	22	57.5	8,340
1078X-6-05C2W	8	-05	7.9	5/16	3/8 - 18NPSM	60	21	22	62.5	9,060
1078X-6-06C2W	10	-06	9.5	3/0	3/8 - 18NPSM	62	21	22	57.5	8,340

Fittings for hydraulic applications

1U08X – BSP female swivel (ballnose)

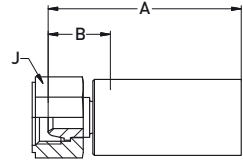

MATERIAL Carbon steel, zinc plated

NOTE C2W: Stainless steel nipple

#	⊙				📐	A	B	J	⊙	
	DN	size	mm	inch					MPa	psi
1U08X-4-04	6	-04	6.4	1/4	G 1/4	58	27	19	80.0	11,600
1U08X-6-04	6	-04	6.4	1/4	G 3/8	58	27	27	80.0	11,600
1U08X-6-05	8	-05	7.9	5/16	G 3/8	59	19	19	67.5	9,790
1U08X-6-06	10	-06	9.5	3/0	G 3/8	61	20	22	52.5	7,610
1U08X-8-06	10	-06	9.5	3/0	G 1/2	61	20	27	52.5	7,610
1U08X-6-05C2W	8	-05	7.9	5/16	G 3/8	59	19	19	67.5	9,790
1U08X-6-06C2W	10	-06	9.5	3/0	G 3/8	61	20	22	52.5	7,610
1U08X-8-06C2W	10	-06	9.5	3/0	G 1/2	61	20	27	52.5	7,610

Fittings for hydraulic applications

13B8X / 13BNX – BSP male

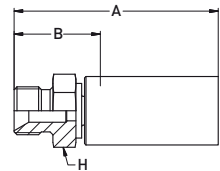

MATERIAL Carbon steel, zinc plated

#	⊙				📐	A	B	H	⊙	
	DN	size	mm	inch					MPa	psi
13B8X-4-025	4	-025	4	5/32	G 1/4	57	30	17	75.0	10,880
13B8X-4-04	6	-04	6.4	1/4	G 1/4	64	32	17	80.0	11,600
13B8X-6-04	6	-04	6.4	1/4	G 3/8	67	35	19	80.0	11,600
13B8X-6-05	8	-05	7.9	5/16	G 3/8	69	30	22	62.5	9,060
13B8X-6-06	10	-06	9.5	3/0	G 3/8	70	30	22	57.5	8,340
13B8X-8-06	10	-06	9.5	3/0	G 1/2	75	35	22	57.5	8,340
13BNX-24-20	32	-20	31.8	1 1/4	G 1 1/2	118	57	55	27.5	3,990

Fittings for hydraulic applications

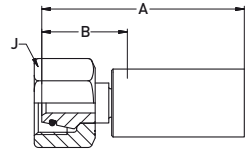
**1C98X / 1C9LX / 1C9NX – Metric female swivel
heavy series with O-ring****MATERIAL** Carbon steel, zinc plated

#	⊙				⌚	A	B	J	↗	
	DN	size	mm	inch					MPa	psi
1C98X-8-025	4	-025	4	5/32	M16x1.5	54	27	19	75.0	10,880
1C98X-8-04	6	-04	6.4	1/4	M16x1.5	59	27	19	80.0	11,600
1C98X-10-04	6	-04	6.4	1/4	M18x1.5	56	33	22	80.0	11,600
1C98X-12-06	10	-06	9.5	3/0	M20x1.5	70	30	24	62.5	9,060
1C98X-14-06	10	-06	9.5	3/0	M22x1.5	70	30	27	57.5	8,340
1C9LX-16-08	12	-08	12.7	1/2	M24x1.5	88	34	32	57.5	8,340
1C9NX-38-20	32	-20	31.8	1 1/4	M52x2	113	52	60	27.5	3,990

Fittings for hydraulic applications

2388N – High pressure hose

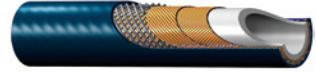

APPLICATIONS

- High pressure service for the construction and shipbuilding industries and for general industrial cleaning applications.
- Mainly used to remove different kinds of dirt accumulation, or materials from various surfaces, such as those in tanks, from concrete and asphalt.

CONSTRUCTION

Core tube : Polyamide
Pressure reinforcement : Two spiral layers and two open spiral layers of high tensile steel wire
Cover : Polyurethane
Colour : Blue for water jetting, black for hydraulic

TEMPERATURE RANGE

-10°C up to +70°C for water jetting applications,
 -40°C up to +100°C for hydraulic applications

Water jetting applications

#	Ø				Ø		↗		✂		↶		kg/m
	DN	size	mm	inch	mm	MPa	psi	MPa	psi	mm	kg/m		
2388N-04V12W	6	-04	6.3	1/4	13.3	128	18,560	320	46,400	80	0.30		
2388N-08V12W	12	-08	13.0	1/2	23.0	110	15,950	275	39,875	100	0.80		



Hydraulic applications

#	Ø				Ø		↗		✂		↶		kg/m
	DN	size	mm	inch	mm	MPa	psi	MPa	psi	mm	kg/m		
2388N-04V00	6	-04	6.3	1/4	13.3	80	11,600	320	46,400	80	0.30		

NOTES -

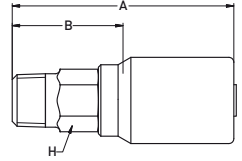
101BS – National Pipe Tapered (NPT) male



**MATERIAL** Carbon steel, zinc plated

#	⊙					A	B	H		
	DN	size	mm	inch		mm	mm	mm	MPa	psi
101BS-4-04	6	-04	6.3	1/4	1/4 NPT	60	30	14	103.5	15,000
101BS-8-08	12	-08	12.7	1/2	1/2 NPT	93	40	22	103.5	15,000

Fittings for water jetting applications

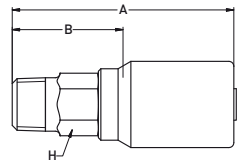
101BS – National Pipe Tapered (NPT) male

**MATERIAL** Stainless steel

#	⊙					A	B	H		
	DN	size	mm	inch		mm	mm	mm	MPa	psi
101BS-8-08C	12	-08	12.7	1/2	1/2 NPT	93	40	22	103.5	15,000

Fittings for water jetting applications

192BS – BSP female swivel (60° cone)

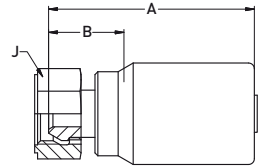

MATERIAL Carbon steel, zinc plated

#	⊙				⌚	A	B	J	↗	
	DN	size	mm	inch		mm	mm	mm	MPa	psi
192BS-4-04	6	-04	6.3	1/4	G 1/4	54	20	19	128	18,560
192BS-8-08	12	-08	12.7	1/2	G1/2	81	28	27	110	15,950

Fittings for water jetting applications

192BS – BSP female swivel (60° cone)

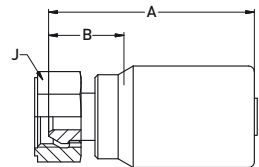

MATERIAL Stainless steel

#	⊙				⌚	A	B	J	↗	
	DN	size	mm	inch		mm	mm	mm	MPa	psi
192BS-8-08C	12	-08	12.7	1/2	G1/2	81	28	27	110	15,950

Fittings for water jetting applications

High pressure

1D9BS – BSP male

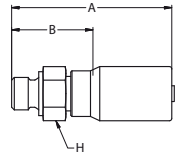

MATERIAL Carbon steel, zinc plated

#						A	B			
	DN	size	mm	inch		mm	mm	mm	MPa	psi
1D9BS-4-04	6	-04	6.3	1/4	G 1/4	66	35	19	128	18,560

Fittings for water jetting applications

High pressure

65Y8X – Medium pressure female swivel

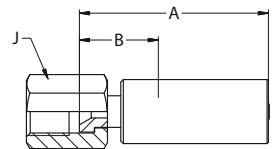

MATERIAL Carbon steel, zinc plated

#						A	B			
	DN	size	mm	inch		mm	mm	mm	MPa	psi
65Y8X-6-4	6	-04	6.4	1/4	9/16 - 18	71	39	19	112.0	16,240

Fittings for water jetting applications

1C9BS – Metric female swivel heavy series with O-ring

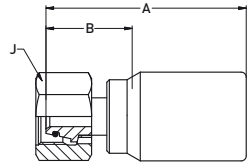

MATERIAL Carbon steel, zinc plated

#	⊙				⋈	A	B	J	⊙	
	DN	size	mm	inch					MPa	psi
1C9BS-10-04	6	-04	6.3	1/4	M18x1.5	63	32	22	128	18,560
1C9BS-16-04	6	-04	6.3	1/4	M24x1.5	65	34	30	128	18,560
1C9BS-14-08	12	-08	12.7	1/2	M22x1.5	89	36	27	110	15,950
1C9BS-16-08	12	-08	12.7	1/2	M24x1.5	89	36	30	110	15,950

Fittings for water jetting applications

1C9BS – Metric female swivel heavy series with O-ring

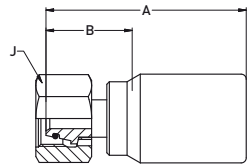

MATERIAL Stainless steel

#	⊙				⋈	A	B	J	⊙	
	DN	size	mm	inch					MPa	psi
1C9BS-14-08C	12	-08	12.7	1/2	M22x1.5	89	36	27	110	15,950
1C9BS-16-08C	12	-08	12.7	1/2	M24x1.5	89	36	30	110	15,950

Fittings for water jetting applications

1AYBS – Type “M” female swivel

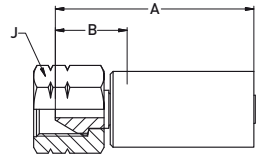

MATERIAL Carbon steel, zinc plated

#						A	B			
	DN	size	mm	inch		mm	mm	mm	MPa	psi
1AYBS-11-08	12	-08	12,7	1/2	1 - 12 UNF	77	31	32	110	15,950

Fittings for water jetting applications

1AY8X – Type “M” female swivel

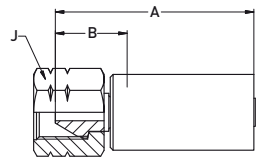

MATERIAL Carbon steel, zinc plated

#						A	B			
	DN	size	mm	inch		mm	mm	mm	MPa	psi
1AY8X-6-04	6	-04	6,4	1/4	9/16 - 18 UNF	65	33	19	80	11,600

Fittings for hydraulic applications

High pressure

1018X – National Pipe Tapered (NPT) male

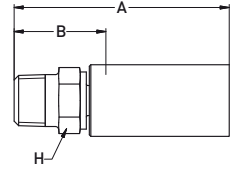

MATERIAL Carbon steel, zinc plated

#	⊙				⌚	A	B	H	⊙	
	DN	size	mm	inch		mm	mm	mm	MPa	psi
1018X-4-04	6	-04	6.4	1/4	1/4 - 18NPTF	65	33	14	80	11,600
1018X-6-04	6	-04	6.4	1/4	3/8 - 18NPTF	67	35	19	80	11,600

Fittings for hydraulic applications

1068X – JIC female swivel

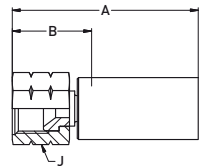

MATERIAL Carbon steel, zinc plated

#	⊙				⌚	A	B	J	⊙	
	DN	size	mm	inch		mm	mm	mm	MPa	psi
1068X-4-04	6	-04	6.4	1/4	7/16 - 20 UNF	57	26	19	80	11,600
1068X-5-04	6	-04	6.4	1/4	1/2 - 20 UNF	55	24	19	80	11,600
1068X-6-04	6	-04	6.4	1/4	9/16 - 18 UNF	55	24	19	80	11,600

Fittings for hydraulic applications

1928X – BSP female swivel (60° cone)

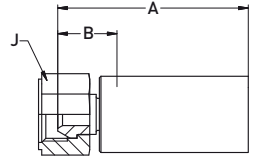

MATERIAL Carbon steel, zinc plated

#						A	B			
	DN	size	mm	inch		mm	mm	mm	MPa	psi
1928X-4-04	6	-04	6.4	1/4	G 1/4	56	25	19	80	11,600

Fittings for hydraulic applications

High pressure

1D98X – BSP male

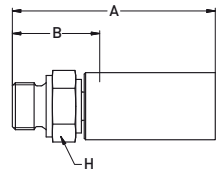

MATERIAL Carbon steel, zinc plated



#						A	B			
	DN	size	mm	inch		mm	mm	mm	MPa	psi
1D98X-4-04	6	-04	6.4	1/4	G 1/4	67	35	19	80	11,600

Fittings for hydraulic applications

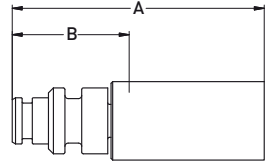
1MB8X – Male stecko



MATERIAL Carbon steel, zinc plated



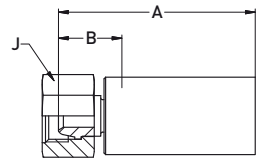

#						A	B	R		
	DN	size	mm	inch		mm	mm	mm	MPa	psi
1MB8X-6-04	6	-04	6.4	1/4	-	72	40	22	69.0	10,000

Fittings for hydraulic applications

1C38X – Metric female swivel light series







MATERIAL Carbon steel, zinc plated

#						A	B			
	DN	size	mm	inch		mm	mm	mm	MPa	psi
1C38X-8-04	6	-04	6.4	1/4	M14 x 1.5	62	30	199	80	11,600

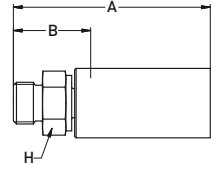
Fittings for hydraulic applications

1058X – UNF male with O-ring



**MATERIAL** Carbon steel, zinc plated

#	⊙					A	B			
	DN	size	mm	inch	inch	mm	mm	mm	MPa	psi
1058X-4-04	6	-04	6.4	1/4	7/16 - 20 UNF	61	29	14	80	11,600
1058X-6-04	6	-04	6.4	1/4	9/16 - 18 UNF	62	30	17	80	11,600

Fittings for hydraulic applications

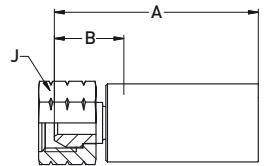
1078X – 60° NPSM female swivel

**MATERIAL** Carbon steel, zinc plated**NOTE** C2W: Stainless steel nipple

#	⊙					A	B			
	DN	size	mm	inch	inch	mm	mm	mm	MPa	psi
1078X-4-04	6	-04	6.4	1/4	1/4 - 18NPSM	59	28	19	80	11,600
1078X-4-04C2W	6	-04	6.4	1/4	1/4 - 18NPSM	59	28	19	80	11,600

Fittings for hydraulic applications

1U08X – BSP female swivel (ballnose)

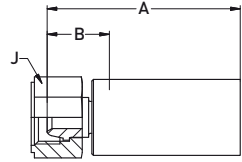

MATERIAL Carbon steel, zinc plated

NOTE C2W: Stainless steel nipple

#						A	B			
	DN	size	mm	inch		mm	mm	mm	MPa	psi
1U08X-4-04	6	-04	6.4	1/4	G 1/4	58	27	19	80	11,600
1U08X-6-04	6	-04	6.4	1/4	G 3/8	58	27	27	80	11,600
1U08X-4-04C2W	6	-04	6.4	1/4	G 1/4	58	27	19	80	11,600
1U08X-6-04C2W	6	-04	6.4	1/4	G 3/8	58	27	27	80	11,600

Fittings for hydraulic applications

13B8X – BSP male

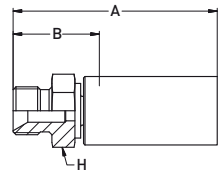

MATERIAL Carbon steel, zinc plated

#						A	B			
	DN	size	mm	inch		mm	mm	mm	MPa	psi
13B8X-4-04	6	-04	6.4	1/4	G 1/4	64	32	17	80	11,600
13B8X-6-04	6	-04	6.4	1/4	G 3/8	67	35	19	80	11,600

Fittings for hydraulic applications

High pressure

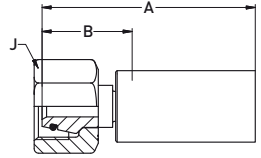
**1C98X – Metric female swivel heavy series
with O-ring****MATERIAL** Carbon steel, zinc plated

#	⊙				⌚	A	B	J	↗	
	DN	size	mm	inch					MPa	psi
1C98X-8-04	6	-04	6.4	1/4	M16x1.5	59	27	19	80	11,600
1C98X-10-04	6	-04	6.4	1/4	M18x1.5	65	33	22	80	11,600

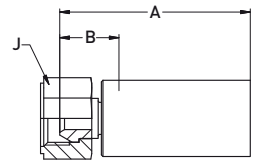
Fittings for hydraulic applications**1928X – BSP female swivel (60° cone)****MATERIAL** Carbon steel, zinc plated

#	⊙				⌚	A	B	J	↗	
	DN	size	mm	inch					MPa	psi
1928X-4-04	6	-04	6.4	1/4	G 1/4	56	25	19	80	11,600

Fittings for hydraulic applications

2580N – High pressure water jetting hose



APPLICATIONS

- High pressure service for the construction and shipbuilding industries and for general industrial cleaning applications.
- Mainly used to remove different kinds of dirt accumulation, or materials from various surfaces, such as those in tanks, from concrete and asphalt, etc.







CONSTRUCTION

Core tube : Polyamide
Pressure reinforcement : Four spiral layers and two open spiral layers of high tensile steel wire
Cover : Polyurethane
Colour : Dark blue

TEMPERATURE RANGE

-10°C up to +70°C

Water jetting applications

#													
	DN	size	mm	inch	mm	MPa	psi	MPa	psi	mm	kg/m		
2580N-06V12	10	-06	9.8	3/8	21.6	160	23,200	400	58,000	95	0.94		
2580N-08V12	12	-08	12.9	1/2	25.0	140	20,300	350	50,750	110	1.19		
2580N-12V12	20	-12	19.8	3/4	32.6	120	17,400	300	43,500	170	1.76		

NOTES -

2580N-MSHA – High pressure mining hose**APPLICATIONS**

- Hydraulic applications in a mining environment







CONSTRUCTION

- Core tube** : Polyamide
Pressure reinforcement : Four spiral layers and two open spiral layers of high tensile steel wire
Cover : Polyurethane, MSHA approved
Colour : Black

TEMPERATURE RANGE

-40°C up to +100°C

Mining applications

#												
	DN	size	mm	inch	mm	MPa	psi	MPa	psi	mm	kg/m	
2580N-06V10-MSHA	10	-06	9.8	3/8	21.6	70	10,150	280	40,600	95	0.94	
2580N-08V10-MSHA	12	-08	12.9	1/2	25.0	70	10,150	280	40,600	110	1.19	

NOTES

101BL – National Pipe Tapered (NPT) male

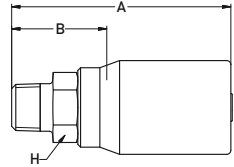

MATERIAL → Carbon steel, zinc plated; ZE: Carbon steel, special plating for high corrosion protection in mining applications

#	⊙				⌚	A	B	⬡H	↻	
	DN	size	mm	inch	inch	mm	mm	mm	MPa	psi
101BL-6-06	10	-06	9.8	3/8	3/8 x 14NPT	80	35	22	160	23,200
101BL-6-06ZE	10	-06	9.8	3/8	3/8 x 14NPT	80	35	22	160	23,200
101BL-8-08	12	-08	12.7	1/2	1/2 x 14NPT	90	45	22	140	20,300
101BL-8-08ZE	12	-08	12.7	1/2	1/2 x 14NPT	90	45	22	140	20,300
101BL-12-12	20	-12	19.6	3/4	3/4 x 14NPT	98	45	30	120	17,400

101BL – National Pipe Tapered (NPT) male

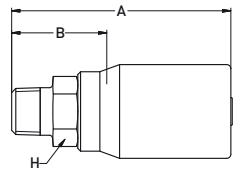

MATERIAL → Stainless steel

#	⊙				⌚	A	B	⬡H	↻	
	DN	size	mm	inch	inch	mm	mm	mm	MPa	psi
101BL-8-08C	12	-08	12.7	1/2	1/2 x 14NPT	90	45	22	140	20,300

192BL – BSP female swivel (60° cone)

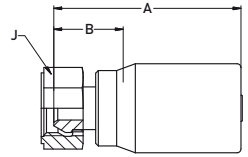

MATERIAL Carbon steel, zinc plated

#	⊙				⌚	A	B	J	↗	
	DN	size	mm	inch					inch	MPa
192BL-6-06	10	-06	9.8	3/8	G3/8	68	24	22	160	23,200
192BL-8-08	12	-08	12.7	1/2	G1/2	71	26	27	140	20,300
192BL-16-12	20	-12	19.6	3/4	G1	82	28	41	120	17,400

High pressure

192BL – BSP female swivel (60° cone)

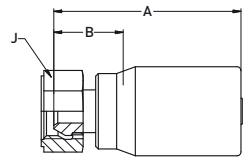

MATERIAL Stainless steel

#	⊙				⌚	A	B	J	↗	
	DN	size	mm	inch					inch	MPa
192BL-8-08C	12	-08	12.7	1/2	G1/2	71	26	27	140	20,300

1C9BL – Metric female swivel heavy series with O-ring

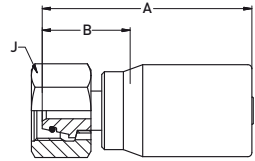

MATERIAL Carbon steel, zinc plated

#	⊙				⌚	⊙	A	B	J	⌚	
	DN	size	mm	inch	mm	mm	mm	mm	mm	MPa	psi
1C9BL-14-06	10	-06	9.8	3/8	M22 x 1.5	14	80	36	30	160	23,200
1C9BL-16-06	10	-06	9.8	3/8	M24 x 1.5	16	84	36	30	160	23,200
1C9BL-14-08	12	-08	12.7	1/2	M22 x 1.5	14	80	36	27	140	20,300
1C9BL-16-08	12	-08	12.7	1/2	M24 x 1.5	16	80	36	30	140	20,300
1C9BL-25-12	20	-12	19.6	3/4	M36 x 2.0	25	97	44	46	120	17,400

1C9BL – Metric female swivel heavy series with O-ring

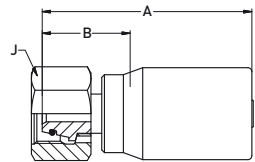

MATERIAL Stainless steel

#	⊙				⌚	⊙	A	B	J	⌚	
	DN	size	mm	inch	mm	mm	mm	mm	mm	MPa	psi
1C9BL-14-08C	12	-08	12.7	1/2	M22 x 1.5	14	80	36	27	140	20,300
1C9BL-16-08C	12	-08	12.7	1/2	M24 x 1.5	16	80	36	30	140	20,300

1AYBL – Type “M” female swivel

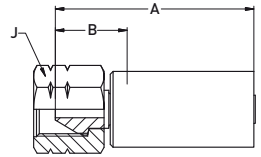

MATERIAL Carbon steel, zinc plated

#	⊙				⌚	A	B	J	↗	
	DN	size	mm	inch					inch	mm
1AYBL-11-06	10	-06	9.8	3/8	1 - 12 UNF	77	31	32	160	23,200
1AYBL-11-08	12	-08	12.7	1/2	1 - 12 UNF	77	31	32	140	20,300

High pressure

1AYBL – Type “M” female swivel

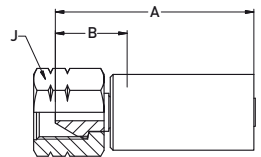

MATERIAL Stainless steel

#	⊙				⌚	A	B	J	↗	
	DN	size	mm	inch					inch	mm
1AYBL-11-08C	12	-08	12.7	1/2	1 - 12 UNF	77	31	32	140	20,300

Chapter E**Ultra-high pressure water jetting hose & fittings****Hose**

2440D – Ultra-high pressure water jetting hose	E-4
2440N – Ultra-high pressure water jetting hose	E-4
2440D – TOUGH COVER Ultra-high pressure water jetting hose	E-5

Related fittings

1C9LX – Metric female swivel heavy series with O-ring	E-6
1AYLX – Type “M” female swivel	E-7
1YMLX – High pressure tube nipple metric – LH thread.....	E-8
1YALX – High pressure tube nipple UNF – LH thread	E-8
1Y4LX – High pressure tube nipple UNF – LH thread	E-8
192LX – BSP female swivel (60° cone).....	E-9
1Y9LX – BSP male for USIT ring.....	E-9
1D9LX – BSP male	E-10
1C3LX – Metric female swivel light series.....	E-10
1C6LX – Metric female swivel heavy series	E-10
1MRLX – Metric female swivel 59° cone.....	E-11
601LX – National Pipe Tapered (NPT) male.....	E-11
6YHLX – UNF male nozzle nipple.....	E-12
6HYLX – UNF female for water jetting nozzle	E-13
66YLX – High pressure female swivel.....	E-13
65YLX – Medium pressure female swivel	E-14
6ZELX – Male water jetting nozzle.....	E-14
6Y2LX – Medium pressure tube nipple.....	E-14

Hose

2640D – Ultra-high pressure water jetting hose	E-15
2640N – Ultra-high pressure water jetting hose	E-15

Related fittings for water jetting applications

1C9JX – Metric female swivel heavy series with O-ring	E-16
1AY2X – Type “M” female swivel	E-16
1AYJX – Type “M” female swivel	E-16
1YM2X – High pressure tube nipple metric – LH thread.....	E-17

Table of contents

1YMJX – High pressure tube nipple metric – LH thread..... E-17
1Y42X – High pressure tube nipple UNF – LH thread E-17
16Y2X – High pressure female swivel..... E-18
6Y25X – Medium pressure tube nipple..... E-18

Related fittings for hydraulic applications

1C95X – Metric female swivel heavy series with O-ring E-19
1AY5X – Type “M” female swivel E-19
1YA5X – High pressure tube nipple UNF – LH thread E-20
1C35X – Metric female swivel light series..... E-20
1925X – BSP female swivel (60° cone)..... E-21
1TM2X – Polyflex Lok components E-21

Hose

2648N – Ultra-high pressure water jetting hose E-22

Related fittings

1Y4CX – High pressure tube nipple UNF – LH thread E-23
1YMCX– High pressure tube nipple metric – LH thread..... E-23
1C9JX – Metric female swivel heavy series with O-ring E-23
1C9CX – Metric female swivel heavy series with O-ring E-23
1AYJX – Type “M” female swivel E-24
1AYCX – Type “M” female swivel E-24
1Y2CX – Medium pressure tube nipple..... E-24

Hose

2740D – Ultra-high pressure water jetting hose E-25

Related fittings

1YM2X – High pressure tube nipple metric – LH thread..... E-26
6YMHX– High pressure tube nipple metric – LH thread..... E-26
1Y42X – High pressure tube nipple UNF – LH thread E-26
6Y4HX – High pressure tube nipple UNF – LH thread E-26
1AY2X – Type “M” female swivel E-27
16Y2X – High pressure female swivel..... E-27
1922X – BSP female swivel (60° cone)..... E-28
1TM2X – Polyflex Lok components E-28

Hose

2741D – Ultra-high pressure water jetting hose	E-29
---	------

Related fittings

1YMDX – High pressure tube nipple metric – LH thread.....	E-30
1YADX – High pressure tube nipple UNF – LH thread	E-30
1AY2X – Type “M” female swivel	E-31
1TM2X – Polyflex Lok components	E-31

Hose

2748D – Ultra-high pressure water jetting hose	E-32
2748D – Ultra-high pressure water jetting hose with 2nd cover.....	E-33

Related fittings

1YM2X – High pressure tube nipple metric – LH thread.....	E-34
1Y42X – High pressure tube nipple UNF – LH thread	E-34
1AY2X – Type “M” female swivel	E-34

2440D / 2440N – Ultra-high pressure water jetting hose

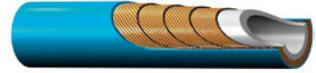

APPLICATIONS

- Ultra-high pressure service for the construction and shipbuilding industries and for general industrial cleaning applications.
- Mainly used for hydrodemolition and removal of accumulated dirt and materials from surfaces such as concrete, asphalt and tanks.
- For use with petroleum or synthetic hydraulic fluids, gas and chemical fluids. Especially suitable for hydraulic pre-tensioning equipment, test rigs, as well as in offshore oil applications.

CONSTRUCTION

Core tube : DN 3-8: Polyoxymethylene; DN 10-25: Polyamide
Pressure reinforcement : Four spiral layers of maximum tensile steel wire

Cover : Polyamide
Colour : DN 3-8: blue; DN 10-25: black

TEMPERATURE RANGE

-10°C up to +70°C

#	Ø				Ø		↗		✂		↶	⏚
	DN	size	mm	inch	mm	MPa	psi	MPa	psi	mm	kg/m	
2440D-02V32	3	-02	3.0	1/8	7.9	207	30,000	518	75,000	100	0.12	
2440D-025V32	4	-025	4.0	5/32	10.4	220	31,900	550	79,750	100	0.21	
2440D-03V32	5	-03	4.8	3/16	11.5	180	26,100	450	65,250	130	0.28	
2440D-04V32	6	-04	6.4	1/4	12.5	164	23,780	410	59,450	155	0.33	
2440D-05V32	8	-05	8.1	5/16	15.1	150	21,750	375	54,375	175	0.44	
2440N-06V30	10	-06	9.7	3/8	19.4	140	20,300	350	50,750	190	0.73	
2440N-08V30	12	-08	12.8	1/2	22.5	130	18,850	325	47,125	200	0.94	
2440N-12V30	20	-12	19.6	3/4	30.0	100	14,500	250	36,250	250	1.39	
2440N-16V30	25	-16	25.0	1	37.0	90	13,050	225	32,625	300	2.00	

NOTES -

2440D-TOUGH COVER – Ultra-high pressure water jetting hose**APPLICATIONS**

- Ultra-high pressure service for the construction and shipbuilding industries and for general industrial cleaning applications.
- Mainly used for hydrodemolition and removal of accumulated dirt and materials from surfaces such as concrete, asphalt and tanks.
- For use with petroleum or synthetic hydraulic fluids, gas and chemical fluids. Especially suitable for hydraulic pre-tensioning equipment, test rigs, as well as in offshore oil applications.







CONSTRUCTION

Core tube : Polyoxymethylene
Pressure reinforcement : Four spiral layers of maximum tensile steel wire

Cover : Polyamide
Colour : blue

TEMPERATURE RANGE

-10°C up to +70°C

#													
	DN	size	mm	inch	mm	MPa	psi	MPa	psi	mm	kg/m		
2440D-025V32-TC	4	-025	3.9	5/32	10.4	220	31,900	550	79,750	100	0.21		
2440D-03V32-TC	5	-03	4.7	3/16	11.5	180	26,100	450	65,250	130	0.28		
2440D-04V32-TC	6	-04	6.3	1/4	12.5	164	23,780	410	59,450	155	0.33		
2440D-05V32-TC	8	-05	8.0	5/16	15.1	150	21,750	375	54,375	175	0.44		

NOTES -

1C9LX

1C9LX – Metric female swivel heavy series with O-ring

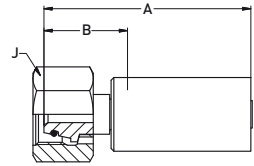

MATERIAL High strength carbon steel, zinc plated

#	⊙				⌚	A	B	J	⌚	
	DN	size	mm	inch					MPa	psi
1C9LX-16-04	6	-04	6.4	1/4	M24x1.5	70	39	30	164	23,780
1C9LX-14-06	10	-06	9.5	3/8	M22x1.5	75	30	30	140	20,300
1C9LX-16-08	12	-08	12.7	1/2	M24x1.5	88	34	32	130	18,850
1C9LX-25-12	20	-12	19.0	3/4	M36x2	92	39	46	100	14,500
1C9LX-30-16	25	-16	25.4	1	M42x2	98	45	50	90	13,050

1C9LX – Metric female swivel heavy series with O-ring

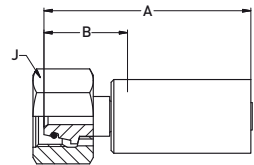

MATERIAL Stainless steel

#	⊙				⌚	A	B	J	⌚	
	DN	size	mm	inch					MPa	psi
1C9LX-16-05C	8	-05	7.9	5/16	M24x1.5	76	37	30	150	21,750
1C9LX-14-06C	10	-06	9.5	3/8	M22x1.5	76	30	30	140	20,300
1C9LX-16-08C	12	-08	12.7	1/2	M24x1.5	87	34	32	130	18,850
1C9LX-25-12C	20	-12	19.0	3/4	M36x2	92	39	46	100	14,500
6C9LX-30-16C	25	-16	25.4	1	M42x2	118	52	50	90	13,050

1AYLX – Type “M” female swivel

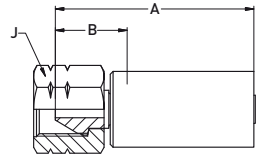

MATERIAL High strength carbon steel, zinc plated

#	⊙				⋈	A	B	J	↻	
	DN	size	mm	inch					MPa	psi
1AYLX-6-02	3	-02	3.0	1/8	9/16 - 18UNF	48	26	22	207	30,000
1AYLX-6-03	5	-03	4.8	3/16	9/16 - 18UNF	66	26	22	180	26,100
1AYLX-6-04	6	-04	6.4	1/4	9/16 - 18UNF	61	29	22	164	23,780
1AYLX-8-05	8	-05	7.9	5/16	3/4 - 16UNF	74	30	27	150	21,750
1AYLX-8-06	10	-06	9.5	3/8	3/4 - 16UNF	70	26	27	140	20,300
1AYLX-11-08	12	-08	12.7	1/2	1 - 12UNF	80	27	32	130	18,850
1AYLX-16-12	20	-12	19.0	3/4	1 5/16-12UNF	82	29	41	100	14,500

Ultra-high pressure

1AYLX – Type “M” female swivel

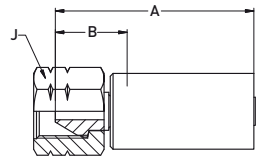

MATERIAL Stainless steel

#	⊙				⋈	A	B	J	↻	
	DN	size	mm	inch					MPa	psi
6AYLX-6-2AC	4	-025	4.0	5/32	9/16 - 18 UNF	64	33	17	220	31,900
1AYLX-6-03C	5	-03	4.8	3/16	9/16 - 18 UNF	67	26	22	180	26,100
1AYLX-8-05C	8	-05	7.9	5/16	3/4 - 16 UNF	70	31	27	150	21,750
1AYLX-8-06C	10	-06	9.5	3/8	3/4 - 16 UNF	70	25	27	140	20,300
1AYLX-11-08C	12	-08	12.7	1/2	1 - 12 UNF	81	27	32	130	18,850
1AYLX-16-12C	20	-12	19.0	3/4	1 5/16-12 UNF	82	29	41	100	14,500
6AYLX-16-16C	25	-16	25.4	1	1 5/16 - 12 UNF	139	52	38	90	13,050

1YMLX – High pressure tube nipple metric – LH thread

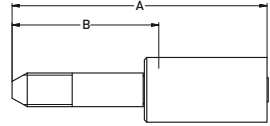

MATERIAL High strength carbon steel, zinc plated

#	⊙				⋈	A	B	↗	
	DN	size	mm	inch				MPa	psi
1YMLX-6-05	8	-05	7.9	5/16	M14x1.5-LH	110	66	150	21,750
1YMLX-11-08	12	-08	12.7	1/2	M18x1.5-LH	120	65	130	18,850

1YALX/1Y4LX – High pressure tube nipple UNF – LH thread

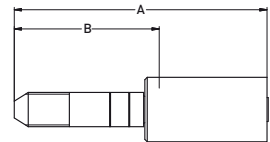

MATERIAL Special materials

#	⊙				⋈	A	B	↗	
	DN	size	mm	inch				MPa	psi
1YALX-1-025	4	-025	4.0	5/32	1/4 - 28UNF-LH	87	50	220	31,900
1YALX-3-025	4	-025	4.0	5/32	3/8 - 24UNF-LH	89	50	220	31,900
1YALX-1-03	5	-03	4.8	3/16	1/4 - 28UNF-LH	92	53	180	26,100
1YALX-3-03	5	-03	4.8	3/16	3/8 - 24UNF-LH	99	57	180	26,100
1YALX-6-03	5	-03	4.8	3/16	9/16 - 18UNF-LH	108	78	180	26,100
1YALX-3-04	6	-04	6.4	1/4	3/8 - 24UNF-LH	102	58	164	23,780
1YALX-6-04	6	-04	6.4	1/4	9/16 - 18UNF-LH	112	67	164	23,780
1YALX-6-05	8	-05	7.9	5/16	9/16 - 18UNF-LH	110	66	150	21,750
1Y4LX-4-02	3	-02	3.0	1/8	1/4 - 28UNF-LH	63	41	207	30,000

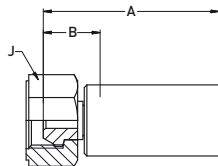
192LX – BSP female swivel (60° cone)**MATERIAL** High strength carbon steel, zinc plated

#	⊙				⌚	A	B	J	↗	
	DN	size	mm	inch					MPa	psi
192LX-4-03	5	-03	4.8	3/16	G 1/4	64	25	22	180	26,100
192LX-6-05	8	-05	7.9	5/16	G 3/8	69	25	27	150	21,750
192LX-8-06	10	-06	9.5	3/8	G 1/2	66	22	30	140	20,300
192LX-8-08	12	-08	12.7	1/2	G 1/2	75	21	32	130	18,850
192LX-16-12	20	-12	19.0	3/4	G 1	77	24	41	100	14,500
192LX-20-16	25	-16	25.4	1	G 1 1/4	78	25	50	90	13,050

Ultra-high pressure

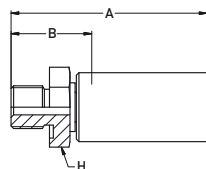
1Y9LX – BSP male for USIT ring**MATERIAL** High strength carbon steel, zinc plated

#	⊙				⌚	A	B	H	↗	
	DN	size	mm	inch					MPa	psi
1Y9LX-4-03	5	-03	4.8	3/16	G 1/4	72	32	22	180	26,100
1Y9LX-8-08	12	-08	12.7	1/2	G 1/2	87	32	36	130	18,850

1D9LX – BSP male

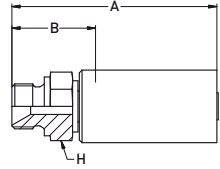

MATERIAL High strength carbon steel, zinc plated

#	⊙				⌚	A	B	H	⌚	
	DN	size	mm	inch					MPa	psi
1D9LX-4-03	5	-03	4.8	3/16	G 1/4	77	35	19	180	26,100
1D9LX-4-04	6	-04	6.4	1/4	G 1/4	80	36	19	164	23,780

1C3LX – Metric female swivel light series

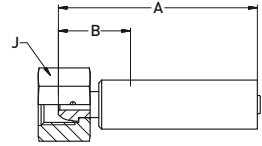

MATERIAL High strength carbon steel, zinc plated

#	⊙				⌚	A	B	J	⌚	
	DN	size	mm	inch					MPa	psi
1C3LX-8-03	5	-03	4.8	3/16	M14x1.5	64	25	22	180	26,100
1C3LX-8-04	6	-04	6.4	1/4	M14x1.5	69	25	22	164	23,780

1C6LX – Metric female swivel heavy series

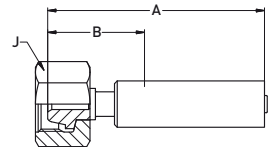

MATERIAL High strength carbon steel, zinc plated

#	⊙				⌚	A	B	J	⌚	
	DN	size	mm	inch					MPa	psi
1C6LX-12-05	8	-05	7.9	5/16	M20x1.5	78	34	27	150	21,750

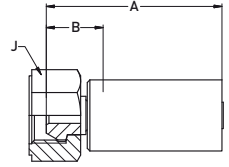
1MRLX – Metric female swivel 59° cone**MATERIAL** High strength carbon steel, zinc plated

#	⊙				⋈	A	B	J	↻	
	DN	size	mm	inch					MPa	psi
1MRLX-6-03	5	-03	4.8	3/16	M12x1.5	92	53	17	180	26,100
1MRLX-8-03	5	-03	4.8	3/16	M14x1.5	66	26	22	180	26,100

Ultra-high pressure

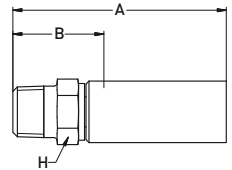
601LX – National Pipe Tapered (NPT) male**MATERIAL** Special materials**NOTE** *ProLance fitting

#	⊙				⋈	A	B	R	↻	
	DN	size	mm	inch					MPa	psi
601LX-2-2AC*	4	-025	4.0	5/32	1/8 NPT ProLance	48	19	13	103.4	15,000
601LX-4-3	5	-03	4.8	3/16	1/4 NPT	73	33	14	103.4	15,000
601LX-2-4	6	-04	6.4	1/4	1/8 NPT	64	30	16	103.4	15,000
601LX-4-4	6	-04	6.4	1/4	1/4 NPT	66	33	16	103.4	15,000
601LX-4-4C	6	-04	6.4	1/4	1/4 NPT	67	34	16	103.4	15,000
601LX-4-5	8	-05	7.9	5/16	1/4 NPT	71	30	16	103.4	15,000
601LX-4-5C	8	-05	7.9	5/16	1/4 NPT	71	30	16	103.4	15,000
601LX-6-5	8	-05	7.9	5/16	3/8 NPT	75	35	19	103.4	15,000
601LX-6-5C	8	-05	7.9	5/16	3/8 NPT	75	35	19	103.4	15,000
601LX-8-8	12	-08	12.7	1/2	1/2 NPT	95	43	29	103.4	15,000
601LX-8-8C	12	-08	12.7	1/2	1/2 NPT	95	43	29	103.4	15,000
601LX-12-12C	20	-12	19.0	3/4	3/4 NPT	121	53	35	69.0	10,000
601LX-16-12C	20	-12	19.0	3/4	1 NPT	124	57	35	69.0	10,000
601LX-16-16C	25	-16	25.4	1	1 NPT	125	64	35	69.0	10,000

6YHLX – UNF male nozzle nipple

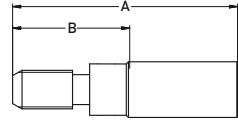

MATERIAL Special materials

NOTE *ProLance fitting

#						A	B		
	DN	size	mm	inch		mm	mm	MPa	psi
6YHLX-4-02-PL	3	-02	3.2	1/8	1/4 - 28 UNF	52	26	207.0	30,000
6YHLX-4-02-PL-LH	3	-02	3.2	1/8	1/4 - 28 UNF LH	52	26	207.0	30,000
6YHLX-4-2AC-PL	4	-025	4.0	5/32	1/4 - 28 UNF	53	22	220.0	31,900
6YHLX-4-2AC-PL-LH	4	-025	4.0	5/32	1/4 - 28 UNF LH	53	22	220.0	31,900
6YHLX-4-3C-PL	5	-03	4.8	3/16	1/4 - 28 UNF	69	39	180.0	26,1000
6YHLX-4-3C-PL-LH	5	-03	4.8	3/16	1/4 - 28 UNF LH	69	39	180.0	26,100
6YHLX-6-3C-PL	5	-03	4.8	3/16	3/8 - 24 UNF	66	36	180.0	26,100
6YHLX-6-3C-PL-LH	5	-03	4.8	3/16	3/8 - 24 UNF LH	66	36	180.0	26,100
6YHLX-6-4C-PL	6	-04	6.4	1/4	3/8 - 24 UNF	66	36	137.9	20,000
6YHLX-6-4C-PL-LH	6	-04	6.4	1/4	3/8 - 24 UNF LH	66	36	137.9	20,000
6YHLX-9-5C-PL	8	-05	7.9	5/16	9/16 - 18 UNF	75	35	137.9	20,000
6YHLX-9-5C-PL-LH	8	-05	7.9	5/16	9/16 - 18 UNF	75	35	137.9	20,000

Ultra-high pressure

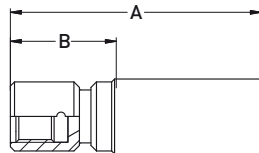
**6HYLX – UNF female
for water jetting nozzle****MATERIAL** Special materials**NOTE** *ProLance fitting

#	⊙				⌚	A	B	↗	
	DN	size	mm	inch				MPa	psi
6HYLX-4-02-PL	3	-02	3.2	1/8	1/4 - 28 UNF	45	20	207.0	30,000
6HYLX-4-0-PL-LH	3	-02	3.2	1/8	1/4 - 28 UNF-LH	45	20	207.0	30,000
6HYLX-4-2AC-PL	4	-025	4.0	5/32	1/4 - 28 UNF	49	21	220.0	31,900
6HYLX-4-2AC-PL-LH	4	-025	4.0	5/32	1/4 - 28 UNF-LH	49	21	220.0	31,900
6HYLX-4-3C-PL	5	-03	4.8	3/16	1/4 - 28 UNF	49	18	180.0	26,100
6HYLX-4-3C-PL-LH	5	-03	4.8	3/16	1/4 - 28 UNF-LH	49	18	180.0	26,100
6HYLX-6-3C-PL	5	-03	4.8	3/16	3/8 - 24 UNF	50	18	180.0	26,100
6HYLX-6-4C-PL	6	-04	6.4	1/4	3/8 - 24 UNF	46	15	137.9	20,000
6HYLX-6-4C-PL-LH	6	-04	6.4	1/4	3/8 - 24 UNF-LH	46	15	137.9	20,000
6HYLX-9-5C-PL	8	-05	7.9	5/16	9/16 - 18 UNF	66	22	137.9	20,000
6HYLX-9-5C-PL-LH	8	-05	7.9	5/16	9/16 - 18 UNF LH	66	22	137.9	20,000

Ultra-high pressure

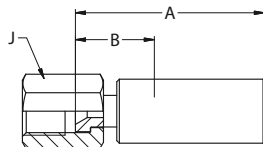
66YLX – High pressure female swivel**MATERIAL** Special materials

#	⊙				⌚	A	B	H	↗	
	DN	size	mm	inch					MPa	psi
66YLX-4-3	5	-03	4.8	3/16	9/16 - 18 UNF	71	33	19	180	26,100
66YLX-4-3C	5	-03	4.8	3/16	9/16 - 18 UNF	74	36	17	180	26,100

65YLX – Medium pressure female swivel

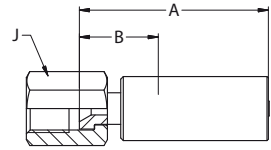

MATERIAL Special materials

#	⊙				⋈	A	B	J	⤵	
	DN	size	mm	inch					MPa	psi
65YLX-6-3	5	-03	4.8	3/16	9/16 - 18	78	39	19	137.9	20,000
65YLX-6-4	6	-04	6.4	1/4	9/16 - 18	72	39	19	137.9	20,000
65YLX-6-4C	6	-04	6.4	1/4	9/16 - 18	72	39	19	137.9	20,000

6ZELX – Male water jetting nozzle

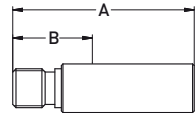

MATERIAL Special materials

NOTE *ProLance fitting

#	⊙				⋈	A	B	⤵	
	DN	size	mm	inch				MPa	psi
6ZELX-5-3C	5	-03	4.8	3/16	5/16 - 24 RH	56	28	137.9	20,000

6Y2LX – Medium pressure tube nipple

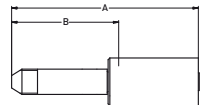

MATERIAL Special materials

#	⊙				⋈	A	B	⤵	
	DN	size	mm	inch				MPa	psi
6Y2LX-9-5C	8	-05	7.9	5/16	9/16 - 18 LH	97	54	137.9	20,000
6Y2LX-12-5C	8	-05	7.9	5/16	3/4 - 16 LH	95	52	137.9	20,000
6Y2LX-9-6C	10	-06	9.5	3/8	9/16 - 18 LH	97	52	137.9	20,000
6Y2LX-9-8C	12	-08	12.7	1/2	9/16 - 18 LH	107	56	137.9	20,000
6Y2LX-12-8C	10	-06	9.5	3/8	3/4 - 16 LH	105	53	137.9	20,000
6Y2LX-16-12C	20	-12	19.0	3/4	1 - 14 LH	137	70	103.4	15,000

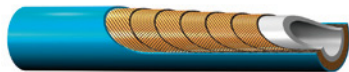
2640D / 2640N – Ultra-high pressure water jetting hose**APPLICATIONS**

- Ultra-high pressure service for the construction and shipbuilding industries and for general industrial cleaning applications.
- Mainly used for hydrodemolition and removal of accumulated dirt and materials from surfaces such as concrete, asphalt and tanks.
- For use with petroleum or synthetic hydraulic fluids, gas and chemical fluids. Especially suitable for hydraulic pre-tensioning equipment, test rigs, as well as in offshore oil applications.

CONSTRUCTION

Core tube : DN 4-8: Polyoxymethylene; DN 12-25: Polyamide
Pressure reinforcement : Six spiral layers of maximum tensile steel wire

Cover : Polyamide
Colour : Blue

TEMPERATURE RANGE

-10°C up to +70°C

#	⊙				⊙		⌚		✂		↷	ⓦ
	DN	size	mm	inch	mm	MPa	psi	MPa	psi	mm	kg/m	
2640D-025V32	4	-025	3.9	5/32	12.0	280	40,600	700	101,500	140	0.29	
2640D-03V32	5	-03	4.8	3/16	13.0	250	36,250	625	90,625	175	0.41	
2640D-05V32	8	-05	8.0	5/16	16.9	210	30,450	525	76,125	225	0.68	
2640N-08V32	12	-08	12.8	1/2	24.5	180	26,100	450	65,250	290	1.36	
2640N-12V32	20	-12	19.6	3/4	33.0	140	20,300	350	50,750	350	2.10	
2640N-16V32	25	-16	25.0	1	40.0	120	17,400	300	43,500	400	2.90	

NOTES -

1C9JX – Metric female swivel heavy series with O-ring

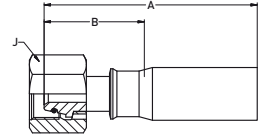

MATERIAL Nipple: very high strength stainless steel
Shell and nut: high strength carbon steel, zinc plated

#	⊙				📏	A	B	J	⊙	
	DN	size	mm	inch					MPa	psi
1C9JX-16-08W	12	-08	12.7	1/2	M24x1.5	96	39	32	180	26,100
1C9JX-25-12W	20	-12	19.0	3/4	M36x2	108	49	46	140	20,300
1C9JX-30-16W	25	-16	25.4	1	M42x2	121	55	55	120	17,400

Fittings for water jetting applications

1AY2X / 1AYJX – Type “M” female swivel

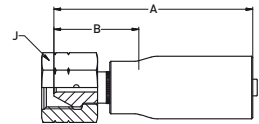

MATERIAL Nipple: very high strength stainless steel
Shell: high strength carbon steel, zinc plated

#	⊙				📏	A	B	J	⊙	
	DN	size	mm	inch					MPa	psi
1AY2X-6-025	4	-025	4.0	5/32	9/16 - 18UNF	61	24	22	300	43,500
1AY2X-6-03	5	-03	4.8	3/16	9/16 - 18UNF	91	38	22	400	58,000
1AY2X-8-05	8	-05	7.9	5/16	3/4 - 16UNF	91	38	27	320	46,400
1AY2X-10-05	8	-05	7.9	5/16	7/8 - 14UNF	91	38	30	320	46,400
1AY2X-13-05	8	-05	7.9	5/16	1 1/8 - 11UNF	91	38	36	320	46,400
1AYJX-11-08W	12	-08	12.7	1/2	1 - 12UNF	86	29	32	180	26,100
1AYJX-16-12W	20	-12	19.0	3/4	1 5/16-12UNF	90	31	41	140	20,300

Fittings for water jetting applications

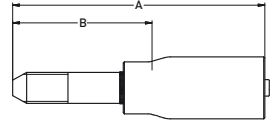
**1YM2X / 1YMJX – High pressure tube nipple
metric – LH thread**

MATERIAL Nipple: very high strength stainless steel
Shell: high strength carbon steel, zinc plated

#	⊙				🌀	A	B	↻	
	DN	size	mm	inch				MPa	psi
1YM2X-6-03	5	-03	4.8	3/16	M14x1.5-LH	116	63	400	58,000
1YM2X-6-05	8	-05	7.9	5/16	M14x1.5-LH	116	63	320	46,400
1YMJX-11-08W	12	-08	12.7	1/2	M18x1.5-LH	141	87	180	26,100
1YMJX-12-08W	12	-08	12.7	1/2	M20x1.5-LH	141	87	180	26,100

Fittings for water jetting applications

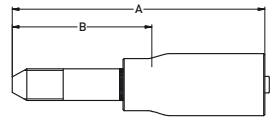
**1Y42X – High pressure tube nipple
UNF – LH thread**

MATERIAL Nipple: very high strength stainless steel
Shell and nut: high strength carbon steel, zinc plated

#	⊙				🌀	A	B	↻	
	DN	size	mm	inch				MPa	psi
1Y42X-4-025	4	-025	4.0	5/32	1/4 - 28UNF-LH	87	50	300	43,500
1Y42X-6-025	4	-025	4.0	5/32	3/8 - 24UNF-LH	92	55	300	43,500
1Y42X-6-03	5	-03	4.8	3/16	3/8 - 24UNF-LH	108	58	400	58,000
1Y42X-9-03	5	-03	4.8	3/16	9/16 - 18UNF-LH	116	63	400	58,000
1Y42X-6-05	8	-05	7.9	5/16	3/8 - 24UNF-LH	116	63	320	46,400
1Y42X-9-05	8	-05	7.9	5/16	9/16 - 18UNF-LH	116	63	320	46,400

Fittings for water jetting applications

16Y2X – High pressure female swivel

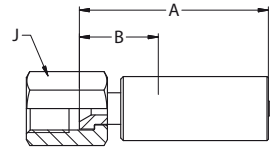

MATERIAL Nipple: very high strength stainless steel
 Shell and nut: high strength carbon steel, zinc plated

#	⊙				⌚	A	B	J	⌚	
	DN	size	mm	inch					MPa	psi
16Y2X-4-025	4	-25	4	5/32	9/16 - 18	76	23	19	300	43,500
16Y2X-4-03	5	-03	4.8	3/16	9/16 - 18	76	23	19	280	40,600

Fittings for water jetting applications

6Y25X – Medium pressure tube nipple

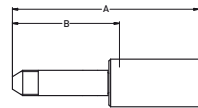

MATERIAL Nipple: very high strength stainless steel
 Shell: stainless steel

#	⊙				⌚	A	B	⌚	
	DN	size	mm	inch				MPa	psi
6Y25X-9-8C	12	-08	12.7	1/2	9/16 - 18 LH	109	56	137.9	20,000
6Y25X-12-8C	10	-06	9.5	3/8	3/4 - 16 LH	107	53	137.9	20,000
6Y25X-16-12C	20	-12	19.0	3/4	1 - 14 LH	139	70	137.9	20,000

Fittings for water jetting applications

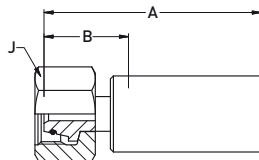
**1C95X – Metric female swivel
heavy series with O-ring**

MATERIAL Nipple: very high strength carbon steel, zinc plated
Shell and nut: high strength carbon steel, zinc plated

#	⊙				📏	A	B	J	↗	
	DN	size	mm	inch					MPa	psi
1C95X-12-05	8	-05	7.9	5/16	M20x1.5	72	28	27	210	30,450
1C95X-16-08	12	-08	12.7	1/2	M24x1.5	87	34	32	180	26,100
1C95X-25-12	20	-12	19	3/4	M36x2	92	39	46	140	20,300

Fittings for hydraulic applications

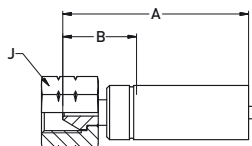
1A5X – Type “M” female swivel

MATERIAL Nipple: very high strength carbon steel, zinc plated
Shell and nut: high strength carbon steel, zinc plated

#	⊙				📏	A	B	J	↗	
	DN	size	mm	inch					MPa	psi
1A5X-6-03	5	-03	4.8	3/16	9/16 - 18UNF	66	26	22	250	36,250
1A5X-8-05	8	-05	7.9	5/16	3/4 - 16UNF	69	25	27	210	30,450
1A5X-11-08	12	-08	12.7	1/2	1 - 12UNF	80	27	32	180	26,100
1A5X-16-12	20	-12	19	3/4	1 5/16 - 12UNF	82	29	41	140	20,300

Fittings for hydraulic applications

1YA5X – High pressure tube nipple UNF – LH thread

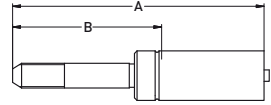

MATERIAL Special materials

#	⊙				🌀	A	B	⊙ ↗	
	DN	size	mm	inch				MPa	psi
1YA5X-1-03	5	-03	4.8	3/16	1/4 - 28UNF-LH	92	53	250	36,250
1YA5X-3-03	5	-03	4.8	3/16	3/8 - 24UNF-LH	97	58	250	36,250
1YA5X-6-05	8	-05	7.9	5/16	9/16 - 18UNF-LH	104	60	210	30,450

Fittings for hydraulic applications

1C35X – Metric female swivel light series

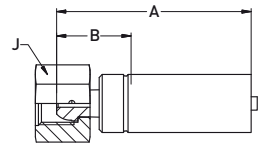

MATERIAL Nipple: very high strength carbon steel, zinc plated
 Shell and nut: high strength carbon steel, zinc plated

#	⊙				🌀	A	B	J	⊙ ↗	
	DN	size	mm	inch					MPa	psi
1C35X-8-03	5	-03	4.8	3/16	M14x1.5	64	25	22	250	36,250

Fittings for hydraulic applications

1925X – BSP female swivel (60° cone)

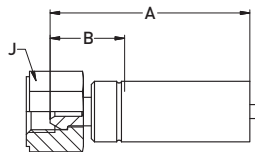

MATERIAL Nipple: very high strength carbon steel, zinc plated
Shell and nut: high strength carbon steel, zinc plated

#	⊙				⌚	A	B	J	↻	
	DN	size	mm	inch					MPa	psi
1925X-4-03	5	-03	4.8	3/16	G 1/4	78	32	22	250	36,250

Fittings for hydraulic applications

1TM2X – Polyflex Lok components



#	Description
1TM2X-8-05-HPK	Fitting for DN8 hoses incl. caps (refer to pages G-2, G-3)
1TM2X-8-03-HPK	Fitting for DN5 hoses incl. caps (refer to pages G-2, G-3)

2648N – Ultra-high pressure water jetting hose



APPLICATIONS

- Ultra-high pressure service for the construction and shipbuilding industries and for general industrial cleaning applications.
- Mainly used for hydrodemolition and removal of accumulated dirt and materials from surfaces such as concrete, asphalt and tanks.

CONSTRUCTION

Core tube : Polyamide
Pressure reinforcement : Six spiral layers of maximum tensile steel wire

Cover : Polyamide
Colour : Blue

TEMPERATURE RANGE

-10°C up to +70°C

#	Ø				Ø		↗		✂		↶	I
	DN	size	mm	inch	mm	MPa	psi	MPa	psi	mm	kg/m	
2648N-08V32	12	-08	12.9	1/2	26.7	210	30,450	525	76,125	290	1.64	
2648N-12V32	20	-12	19.8	3/4	33.7	160	23,200	400	58,000	350	2.28	
2648N-16V32	25	-16	25.0	1	40.8	150	21,750	375	54,375	400	3.10	

NOTES -

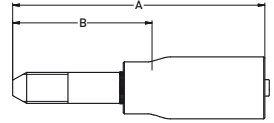
**1Y4CX – High pressure tube nipple
– UNF-LH thread**

MATERIAL Nipple: very high strength stainless steel
Shell: high strength carbon steel, zinc plated

#	⊙				⋯	A	B	⤴	
	DN	size	mm	inch				MPa	psi
1Y4CX-9-08W	12	-08	12.7	1/2	9/16-18UNF-LH	135	70	210	30,450

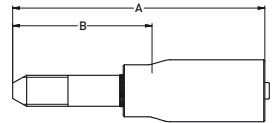
**1YMCX – High pressure tube nipple metric
– LH thread**

MATERIAL Nipple: very high strength stainless steel
Shell: high strength carbon steel, zinc plated

#	⊙				⋯	A	B	⤴	
	DN	size	mm	inch				MPa	psi
1YMJX-11-08W	12	-08	12.7	1/2	M18x1.5-LH	143	82	210	30,450
1YMJX-12-08W	12	-08	12.7	1/2	M20x1.5-LH	143	82	210	30,450

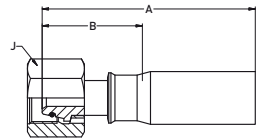
**1C9JX / 1C9CX – Metric female swivel
heavy series with O-ring**



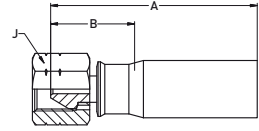

MATERIAL Nipple: very high strength stainless steel
Shell and nut: high strength carbon steel, zinc plated

#	⊙				⋯	A	B	J	⤴	
	DN	size	mm	inch					MPa	psi
1C9JX-25-12W	20	-12	19.0	3/4	M36x2	108	50	46	160	23,200
1C9CX-16-08W	12	-08	12.7	1/2	M24x1.5	112	48	32	210	30,450
1C9CX-30-16W	25	-16	25.4	1	M42x2	121	55	55	150	21,750

1AYJX / 1AYCX – Type “M” female swivel





MATERIAL Nipple: very high strength stainless steel
 Shell and nut: high strength carbon steel, zinc plated

#						A	B			
	DN	size	mm	inch		mm	mm	mm	MPa	psi
1AYJX-16-12W	20	-12	19.0	3/4	1 5/16-12UNF	90	31	41	160	23,200
1AYCX-11-08W	12	-08	12.7	1/2	1-12UNF	102	41	32	210	30,450
1AYCX-16-16W	25	-16	25.4	1	1 5/16-12UNF	146	72	41	138	20,000

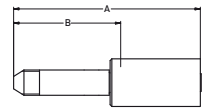
1Y2CX – Medium pressure tube nipple



MATERIAL Nipple: very high strength stainless steel
 Shell and nut: high strength carbon steel, zinc plated

#						A	B		
	DN	size	mm	inch		mm	mm	MPa	psi
1Y2CX-16-16W	25	-16	25.4	1	1-14UNF-LH	146	72	138	20,000

2740D – Ultra-high pressure water jetting hose



APPLICATIONS

- For very-high pressure lances with working pressures up to 300 MPa for the construction and shipbuilding industries or for common industrial cleaning applications.
- Mainly used for hydrodemolition and removal of accumulated dirt and materials from surfaces such as concrete, asphalt and tanks.







CONSTRUCTION

Core tube : Polyoxymethylene
Pressure reinforcement : Six spiral layers of maximum tensile steel wire

Cover : DN4: Polyurethane, DN5-12: Polyamide
Colour : DN4: yellow, DN5-8: red, DN12: black

TEMPERATURE RANGE

-10°C up to +70°C

#													
	DN	size	mm	inch	mm	MPa	psi	MPa	psi	mm	kg/m		
2740D-025V16	4	-025	3.9	5/32	12.0	300	43,500	780	113,100	120	0.40		
2740D-03V34	5	-03	4.8	3/16	13.2	280	40,600	700	101,500	200	0.47		
2740D-05V34	8	-05	7.8	5/16	17.2	250	36,250	625	90,625	200	0.83		
2740D-08V30	12	-08	12.7	1/2	27.0	200	29,000	500	72,500	300	1.85		

NOTES -

1YM2X / 6YMHX – High pressure tube nipple metric – LH thread

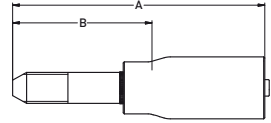

MATERIAL Nipple: very high strength stainless steel
 Shell: high strength carbon steel, zinc plated

#	⊙				⋯	A	B	⊙ ↗	
	DN	size	mm	inch				MPa	psi
1YM2X-6-03	5	-03	4.8	3/16	M14x1.5-LH	116	63	400	58,000
1YM2X-6-05	8	-05	7.9	5/16	M14x1.5-LH	116	63	320	46,400
6YMHX-11-8C	12	-08	12.8	1/2	M18x1.5-LH	189	125	200	29,000
6YMHX-12-8C	12	-08	12.8	1/2	M20x1.5-LH	189	125	200	29,000

1Y42X / 6Y4HX – High pressure tube nipple UNF – LH thread

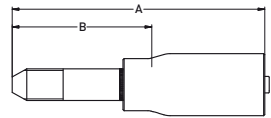

MATERIAL Nipple: very high strength stainless steel
 Shell: high strength carbon steel, zinc plated

#	⊙				⋯	A	B	⊙ ↗	
	DN	size	mm	inch				MPa	psi
1Y42X-4-025	4	-025	4.0	5/32	1/4 - 28UNF-LH	87	50	300	43,500
1Y42X-6-025	4	-025	4.0	5/32	3/8 - 24UNF-LH	92	55	300	43,500
1Y42X-6-03	5	-03	4.8	3/16	3/8 - 24UNF-LH	108	58	400	58,000
1Y42X-9-03	5	-03	4.8	3/16	9/16 - 18UNF-LH	116	63	400	58,000
1Y42X-6-05	8	-05	7.9	5/16	3/8 - 24UNF-LH	116	63	320	46,400
1Y42X-9-05	8	-05	7.9	5/16	9/16 - 18UNF-LH	116	63	320	46,400
6Y4HX-16-8C	12	-08	12.7	1/2	1 - 14UNF-LH	147	77	200	29,000

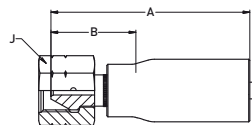
1AY2X – Type “M” female swivel

MATERIAL Nipple: very high strength stainless steel
Shell and nut: high strength carbon steel, zinc plated

#	⊙				🌀	A	B	J	↻	
	DN	size	mm	inch					MPa	psi
1AY2X-6-025	4	-025	4.0	5/32	9/16 - 18UNF	61	24	22	300	43,500
1AY2X-6-03	5	-03	4.8	3/16	9/16 - 18UNF	91	38	22	400	58,000
1AY2X-8-05	8	-05	7.9	5/16	3/4 - 16UNF	91	38	27	320	46,400
1AY2X-10-05	8	-05	7.9	5/16	7/8 - 14UNF	91	38	30	320	46,400
1AY2X-13-05	8	-05	7.9	5/16	1 1/8 - 11UNF	91	38	36	320	46,400

Ultra-high pressure

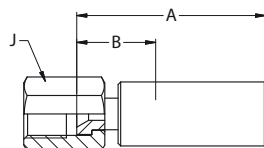
16Y2X – High pressure female swivel

MATERIAL Nipple: very high strength stainless steel
Shell and nut: high strength carbon steel, zinc plated

#	⊙				🌀	A	B	J	↻	
	DN	size	mm	inch					MPa	psi
16Y2X-4-025	4	-25	4	5/32	9/16 - 18	76	23	19	300	43,500
16Y2X-4-03	5	-03	4.8	3/16	9/16 - 18	76	23	19	280	40,600

1922X – BSP female swivel (60° cone)

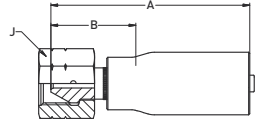

MATERIAL Nipple: very high strength stainless steel
 Shell and nut: high strength carbon steel, zinc plated

#	⊙				⌚	A	B	J	⌚	
	DN	size	mm	inch	inch	mm	mm	mm	MPa	psi
1922X-4-03	5	-03	4.8	3/16	G1/4	79	26	22	280	40,600

1TM2X – Polyflex Lok components



#	Description
1TM2X-8-05-HPK	Fitting for DN8 hoses incl. caps (refer to pages G-2, G-3)
1TM2X-8-03-HPK	Fitting for DN5 hoses incl. caps (refer to pages G-2, G-3)

2741D – Ultra-high pressure water jetting hose



APPLICATIONS

- For very-high pressure lances with working pressures up to 300 MPa for the construction and shipbuilding industries or for common industrial cleaning applications.
- Mainly used for hydrodemolition and removal of accumulated dirt and materials from surfaces such as concrete, asphalt and tanks.

CONSTRUCTION

Core tube : Polyoxymethylene







Pressure reinforcement : Six spiral layers of maximum tensile steel wire

Cover : 1st: Polyamide; 2nd: Polyurethane, abrasion resistant

Colour : 1st: Red; 2nd: Black

TEMPERATURE RANGE

-10°C up to +70°C

#													
	DN	size	mm	inch	mm	MPa	psi	MPa	psi	mm	kg/m		
2741D-05V34/10	8	-05	7.7	5/16	21.2	250	36,250	625	90,625	200	0.95		

NOTES -

1YM2X – High pressure tube nipple metric – LH thread

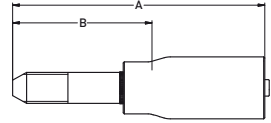

MATERIAL Nipple: very high strength stainless steel
 Shell: high strength carbon steel, zinc plated

#						A	B		
	DN	size	mm	inch				mm	mm
1YM2X-6-05	8	-05	7.9	5/16	M14x1.5-LH	116	63	320	46,400

1Y42X – High pressure tube nipple UNF – LH thread

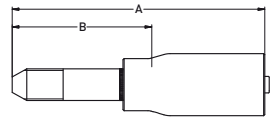

MATERIAL Nipple: very high strength stainless steel
 Shell: high strength carbon steel, zinc plated

#						A	B		
	DN	size	mm	inch				mm	mm
1Y42X-6-05	8	-05	7.9	5/16	3/8 - 24UNF-LH	116	63	320	46,400
1Y42X-9-05	8	-05	7.9	5/16	9/16 - 18UNF-LH	116	63	320	46,400

1AY2X – Type “M” female swivel

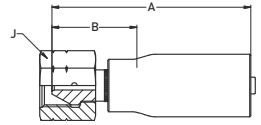

MATERIAL Nipple: very high strength stainless steel
Shell and nut: high strength carbon steel, zinc plated

#	⊙				🌀	A	B	J	↻	
	DN	size	mm	inch					MPa	psi
1AY2X-8-05	8	-05	7.9	5/16	3/4 - 16UNF	91	38	27	320	46,400
1AY2X-10-05	8	-05	7.9	5/16	7/8 - 14UNF	91	38	30	320	46,400
1AY2X-13-05	8	-05	7.9	5/16	1 1/8 - 11UNF	91	38	36	320	46,400

Ultra-high pressure

1TM2X – Polyflex Lok components



#	Description
1TM2X-8-05-HPK	Fitting for DN8 hoses incl. caps (refer to pages G-2, G-3)
1TM2X-8-03-HPK	Fitting for DN5 hoses incl. caps (refer to pages G-2, G-3)

2748D – Ultra-high pressure water jetting hose



APPLICATIONS

- For very-high pressure lances with working pressures up to 300 MPa for the construction and shipbuilding industries or for common industrial cleaning applications.
- Mainly used for hydrodemolition and removal of accumulated dirt and materials from surfaces such as concrete, asphalt and tanks.

CONSTRUCTION

Core tube : Polyoxymethylene
Pressure reinforcement : Six spiral layers of maximum tensile steel wire

Cover : Polyamide
Colour : Red

TEMPERATURE RANGE

-10°C up to +70°C

#	Ø				Ø		↗		✂		↶	I
	DN	size	mm	inch	mm	MPa	psi	MPa	psi	mm	kg/m	
2748D-05V34	8	-05	7.8	5/16	17.3	280	40,600	700	101,500	230	0.83	

NOTES -

2748D – Ultra-high pressure water jetting hose with 2nd cover



APPLICATIONS

- For very-high pressure lances with working pressures up to 300 MPa for the construction and shipbuilding industries or for common industrial cleaning applications.
- Mainly used for hydrodemolition and removal of accumulated dirt and materials from surfaces such as concrete, asphalt and tanks.

CONSTRUCTION

Core tube : Polyoxymethylene







Pressure reinforcement : Six spiral layers of maximum tensile steel wire

Cover : 1st: Polyamide; 2nd: Polyurethane, abrasion resistant

Colour : 1st: Red; 2nd: Yellow

TEMPERATURE RANGE

-10°C up to +70°C



#												
	DN	size	mm	inch	mm	MPa	psi	MPa	psi	mm	kg/m	
2748D-05V34/16	8	-05	7.8	5/16	21.8	280	40,600	700	101,500	230	0.99	

NOTES -

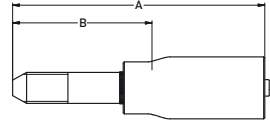
1YM2X – High pressure tube nipple metric – LH thread





MATERIAL Nipple: very high strength stainless steel
 Shell: high strength carbon steel, zinc plated

#						A	B		
	DN	size	mm	inch		mm	mm	MPa	psi
1YM2X-6-05	8	-05	7.9	5/16	M14x1.5-LH	116	63	320	46,400

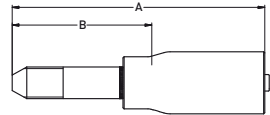
1Y42X – High pressure tube nipple UNF – LH thread





MATERIAL Nipple: very high strength stainless steel
 Shell: high strength carbon steel, zinc plated

#						A	B		
	DN	size	mm	inch		mm	mm	MPa	psi
1Y42X-6-05	8	-05	7.9	5/16	3/8 - 24UNF-LH	116	63	320	46,400
1Y42X-9-05	8	-05	7.9	5/16	9/16 - 18UNF-LH	116	63	320	46,400

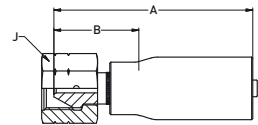
1AY2X – Type “M” female swivel



MATERIAL Nipple: very high strength stainless steel
 Shell and nut: high strength carbon steel, zinc plated

#						A	B	J		
	DN	size	mm	inch		mm	mm	mm	MPa	psi
1AY2X-8-05	8	-05	7.9	5/16	3/4 - 16UNF	91	38	27	320	46,400
1AY2X-10-05	8	-05	7.9	5/16	7/8 - 14UNF	91	38	30	320	46,400
1AY2X-13-05	8	-05	7.9	5/16	1 1/8 - 11UNF	91	38	36	320	46,400

Chapter F**Ultra-high pressure hose & fittings
for ultra-high water pressure equipment****Hose****2840D** – Ultra-high pressure hose for ultra-high pressure water jetting...F-2**Related fittings****1YM2X** – High pressure tube nipple metric – LH thread.....F-3**6YMWX** – High pressure tube nipple metric – LH thread.....F-3**1Y42X** – High pressure tube nipple UNF – LH threadF-3**6Y4WX** – High pressure tube nipple UNF – LH threadF-3**1AY2X** – Type “M” female swivelF-4**1TM2X** – Polyflex Lok componentsF-4**Hose****2841D** – Ultra-high pressure hose for ultra-high pressure water jetting...F-5**Related fittings****1YM2X** – High pressure tube nipple metric – LH thread.....F-6**1Y42X** – High pressure tube nipple UNF – LH threadF-6**1AY2X** – Type “M” female swivelF-7**1TM2X** – Polyflex Lok componentsF-7**Hose****2848D** – Ultra-high pressure hose for ultra-high pressure water jetting...F-8**Related fittings****1YM2X** – High pressure tube nipple metric – LH thread.....F-9**1Y42X** – High pressure tube nipple UNF – LH threadF-9**1AY2X** – Type “M” female swivelF-10**1TM2X** – Polyflex Lok componentsF-10**Hose****2849D** – Ultra-high pressure hose for ultra-high pressure water jetting...F-11**Related fittings****6YMWX** – High pressure tube nipple metric – LH thread.....F-12**6Y4WX** – High pressure tube nipple UNF – LH threadF-12**6AYWX** – Type “M” female swivelF-13

2840D – Ultra-high pressure water jetting hose for ultra-high pressure water jetting



APPLICATIONS

- Ultra-high pressure service for water jet cutting equipment with water only or with abrasive additives.
- Replaces steel pipe where flexibility is important. Compression forming (hydroforming):
A manufacturing procedure applying water pressure to produce complex hollow parts made from pipe-like basic materials.







CONSTRUCTION

Core tube : Polyoxymethylene
Pressure reinforcement : Eight spiral layers of maximum tensile steel wire

Cover : Polyamide
Colour : DN5: red, DN8: yellow, DN12: black

TEMPERATURE RANGE

-10°C up to +70°C

#														
	DN	size	mm	inch	mm	MPa	psi	MPa	psi	mm	kg/m			
2840D-03V34	5	-03	4.6	3/16	15.0	400	58,000	800	116,000	200	0.66			
2840D-05V36	8	-05	7.8	5/16	19.5	300	43,500	700	101,500	250	1.10			
2840D-08V30	12	-08	12.7	1/2	29.8	250	36,250	625	90,625	350	2.50			

NOTES

The safety factor of burst pressure over working pressure can be adjusted to the specific application but must not be reduced below a ratio of 1:2.

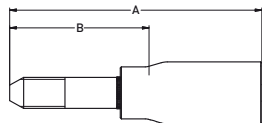
**1YM2X / 6YMWX – High pressure tube nipple
metric – LH thread**

MATERIAL Nipple: very high strength stainless steel
Shell: high strength carbon steel, zinc plated

#	⊙				🌀	A	B	↻	
	DN	size	mm	inch				MPa	psi
1YM2X-6-03	5	-03	4.8	3/16	M14x1.5-LH	116	63	400	58,000
1YM2X-6-05	8	-05	7.9	5/16	M14x1.5-LH	116	63	320	46,400
6YMWX-11-8C	12	-08	12.8	1/2	M18x1.5-LH	189	125	200	29,000
6YMWX-12-8C	12	-08	12.8	1/2	M20x1.5-LH	190	125	250	36,250

Ultra-high pressure

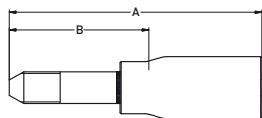
**1Y42X / 6Y4WX – High pressure tube nipple
metric – UNF thread**

MATERIAL Nipple: very high strength stainless steel
Shell: high strength carbon steel, zinc plated

#	⊙				🌀	A	B	↻	
	DN	size	mm	inch				MPa	psi
1Y42X-6-03	5	-03	4.8	3/16	3/8 - 24UNF-LH	108	58	400	58,000
1Y42X-9-03	5	-03	4.8	3/16	9/16 - 18UNF-LH	116	63	400	58,000
1Y42X-6-05	8	-05	7.9	5/16	3/8 - 24UNF-LH	116	63	320	46,400
1Y42X-9-05	8	-05	7.9	5/16	9/16 - 18UNF-LH	116	63	320	46,400
6Y4WX-16-8C	12	-08	12.7	1/2	1 - 14UNS-LH	147	77	250	36,250

1AY2X

1AY2X – Type “M” female swivel

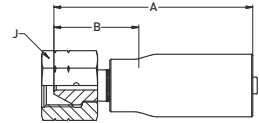

MATERIAL

Nipple: very high strength stainless steel

Shell and nut: high strength carbon steel, zinc plated

#	⊙				⌚	A	B	J	⊙ ↗	
	DN	size	mm	inch					MPa	psi
1AY2X-6-03	5	-03	4.8	3/16	9/16 - 18UNF	91	38	22	400	58,000
1AY2X-8-05	8	-05	7.9	5/16	3/4 - 16UNF	91	38	27	320	46,400
1AY2X-10-05	8	-05	7.9	5/16	7/8 - 14UNF	91	38	30	320	46,400
1AY2X-13-05	8	-05	7.9	5/16	1 1/8 - 11UNF	91	38	36	320	46,400

1TM2X – Polyflex Lok components



#	Description
1TM2X-8-05-HPK	Fitting for DN8 hoses incl. caps (refer to pages G-2, G-3)
1TM2X-8-03-HPK	Fitting for DN5 hoses incl. caps (refer to pages G-2, G-3)

2841D – Ultra-high pressure water jetting hose for ultra-high pressure water jetting



APPLICATIONS







- Ultra-high pressure service for water jet cutting equipment with water only or with abrasive additives. Replaces steel pipe where flexibility is important.
- Compression forming (hydroforming):
A manufacturing procedure applying water pressure to produce complex hollow parts made from pipe-like basic materials.

CONSTRUCTION

- Core tube** : Polyoxymethylene
Pressure reinforcement : Eight spiral layers of maximum tensile steel wire
- Cover** : 1st: Polyamide; 2nd: Polyurethane, abrasion resistant
Colour : 1st: Yellow; 2nd: Grey

TEMPERATURE RANGE

-10°C up to +70°C



#												
	DN	size	mm	inch	mm	MPa	psi	MPa	psi	mm	kg/m	
2841D-05V36/17	8	-05	7.7	5/16	23.5	300	43,500	700	101,500	250	1.38	

NOTES

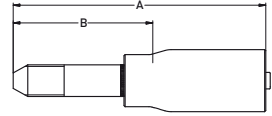
1YM2X – High pressure tube nipple metric – LH thread





MATERIAL Nipple: very high strength stainless steel
 Shell: high strength carbon steel, zinc plated

#						A	B		
	DN	size	mm	inch				mm	mm
1YM2X-6-05	8	-05	7.9	5/16	M14x1.5-LH	116	63	320	46,400

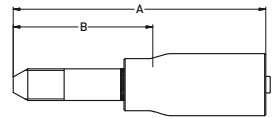
1Y42X – High pressure tube nipple UNF – LH thread



MATERIAL Nipple: very high strength stainless steel
 Shell: high strength carbon steel, zinc plated

#						A	B		
	DN	size	mm	inch				mm	mm
1Y42X-6-05	8	-05	7.9	5/16	3/8 - 24UNF-LH	116	63	320	46,400
1Y42X-9-05	8	-05	7.9	5/16	9/16 - 18UNF-LH	116	63	320	46,400

1AY2X – Type “M” female swivel

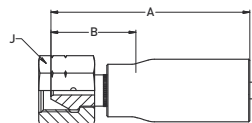

MATERIAL

Nipple: very high strength stainless steel

Shell and nut: high strength carbon steel, zinc plated

#	⊙				⌚	A	B	J	↗	
	DN	size	mm	inch					MPa	psi
1AY2X-8-05	8	-05	7.9	5/16	3/4 - 16UNF	91	38	27	320	46,400
1AY2X-10-05	8	-05	7.9	5/16	7/8 - 14UNF	91	38	30	320	46,400
1AY2X-13-05	8	-05	7.9	5/16	1 1/8 - 11UNF	91	38	36	320	46,400

1TM2X – Polyflex Lok components



#	Description
1TM2X-8-05-HPK	Fitting for DN8 hoses incl. caps (refer to pages G-2, G-3)
1TM2X-8-03-HPK	Fitting for DN5 hoses incl. caps (refer to pages G-2, G-3)

2848D – Ultra-high pressure water jetting hose for ultra-high pressure water jetting



APPLICATIONS

- Ultra-high pressure service for water jet cutting equipment with water only or with abrasive additives. Replaces steel pipe where flexibility is important.
- Compression forming (hydroforming):
 A manufacturing procedure applying water pressure to produce complex hollow parts made from pipe-like basic materials.

CONSTRUCTION

Core tube : Polyoxymethylene
Pressure reinforcement : Eight spiral layers of maximum tensile steel wire

Cover : Polyamide
Colour : Red

TEMPERATURE RANGE

-10°C up to +70°C

#	Ø				Ø		↗		✂		↶	I
	DN	size	mm	inch	mm	MPa	psi	MPa	psi	mm	kg/m	
2848D-05V34	8	-05	7.8	5/16	19.6	320	46,400	800	116,000	280	1.10	

NOTES

1YM2X – High pressure tube nipple metric – LH thread

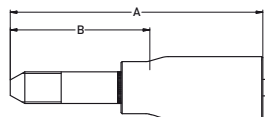

MATERIAL Nipple: very high strength stainless steel
Shell: high strength carbon steel, zinc plated

#	⊙				⋈	A	B	⊙ ↗	
	DN	size	mm	inch				MPa	psi
1YM2X-6-05	8	-05	7.9	5/16	M14x1.5-LH	116	63	320	46,400

1Y42X – High pressure tube nipple UNF – LH thread

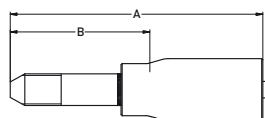

MATERIAL Nipple: very high strength stainless steel
Shell: high strength carbon steel, zinc plated

#	⊙				⋈	A	B	⊙ ↗	
	DN	size	mm	inch				MPa	psi
1Y42X-6-05	8	-05	7.9	5/16	3/8 - 24UNF-LH	116	63	320	46,400
1Y42X-9-05	8	-05	7.9	5/16	9/16 - 18UNF-LH	116	63	320	46,400

1AY2X

1AY2X – Type “M” female swivel

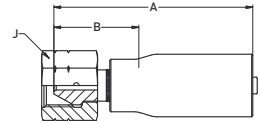

MATERIAL

Nipple: very high strength stainless steel

Shell and nut: high strength carbon steel, zinc plated

#	⊙				⋄	A	B	J	⊙	
	DN	size	mm	inch					MPa	psi
1AY2X-8-05	8	-05	7.9	5/16	3/4 - 16UNF	91	38	27	320	46,400
1AY2X-10-05	8	-05	7.9	5/16	7/8 - 14UNF	91	38	30	320	46,400
1AY2X-13-05	8	-05	7.9	5/16	1 1/8 - 11UNF	91	38	36	320	46,400

1TM2X – Polyflex Lok components



#	Description
1TM2X-8-05-HPK	Fitting for DN8 hoses incl. caps (refer to pages G-2, G-3)
1TM2X-8-03-HPK	Fitting for DN5 hoses incl. caps (refer to pages G-2, G-3)

2849D – Ultra-high pressure water jetting hose for ultra-high pressure water jetting



APPLICATIONS

- Ultra-high pressure service for water jet cutting equipment with water only or with abrasive additives. Replaces steel pipe where flexibility is important.
- Compression forming (hydroforming):
A manufacturing procedure applying water pressure to produce complex hollow parts made from pipe-like basic materials.







CONSTRUCTION

Core tube : Polyoxymethylene
Pressure reinforcement : Eight spiral layers of maximum tensile steel wire

Cover : Polyamide
Colour : Red

TEMPERATURE RANGE

-10°C up to +70°C



#												
	DN	size	mm	inch	mm	MPa	psi	MPa	psi	mm	kg/m	
2849D-05V34	8	-05	7.8	5/16	19.6	380	55,000	800	116,000	280	1.10	

NOTES

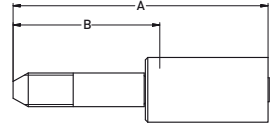
6YMWX – High pressure tube nipple metric – LH thread





MATERIAL Nipple: very high strength stainless steel
 Shell: high strength carbon steel, zinc plated

#						A	B		
	DN	size	mm	inch		mm	mm	MPa	psi
6YMWX-6-5C-55	8	-05	7.9	5/16	M14x1.5-LH	130	63	380	55,000

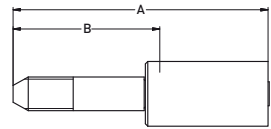
6Y4WX – High pressure tube nipple UNF – LH thread





MATERIAL Nipple: very high strength stainless steel
 Shell: high strength carbon steel, zinc plated

#						A	B		
	DN	size	mm	inch		mm	mm	MPa	psi
6Y4WX-9-5C-55	8	-05	7.9	5/16	9/16 - 18 UNF-LH	130	63	380	55,000

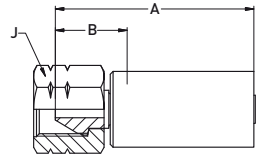
6AYWX – Type “M” female swivel



MATERIAL Nipple: very high strength stainless steel
 Shell and nut: high strength carbon steel, zinc plated

#	⊙				 inch	A mm	B mm	 mm		
	DN	size	mm	inch					MPa	psi
6AYWX-10-5C-55	8	-05	7.9	5/16	7/8 - 14	113	45	32	380	55,000

Ultra-high pressure

Chapter G

Polyflex-Lok

Polyflex-Lok componentsG-2

Polyflex-Lok components

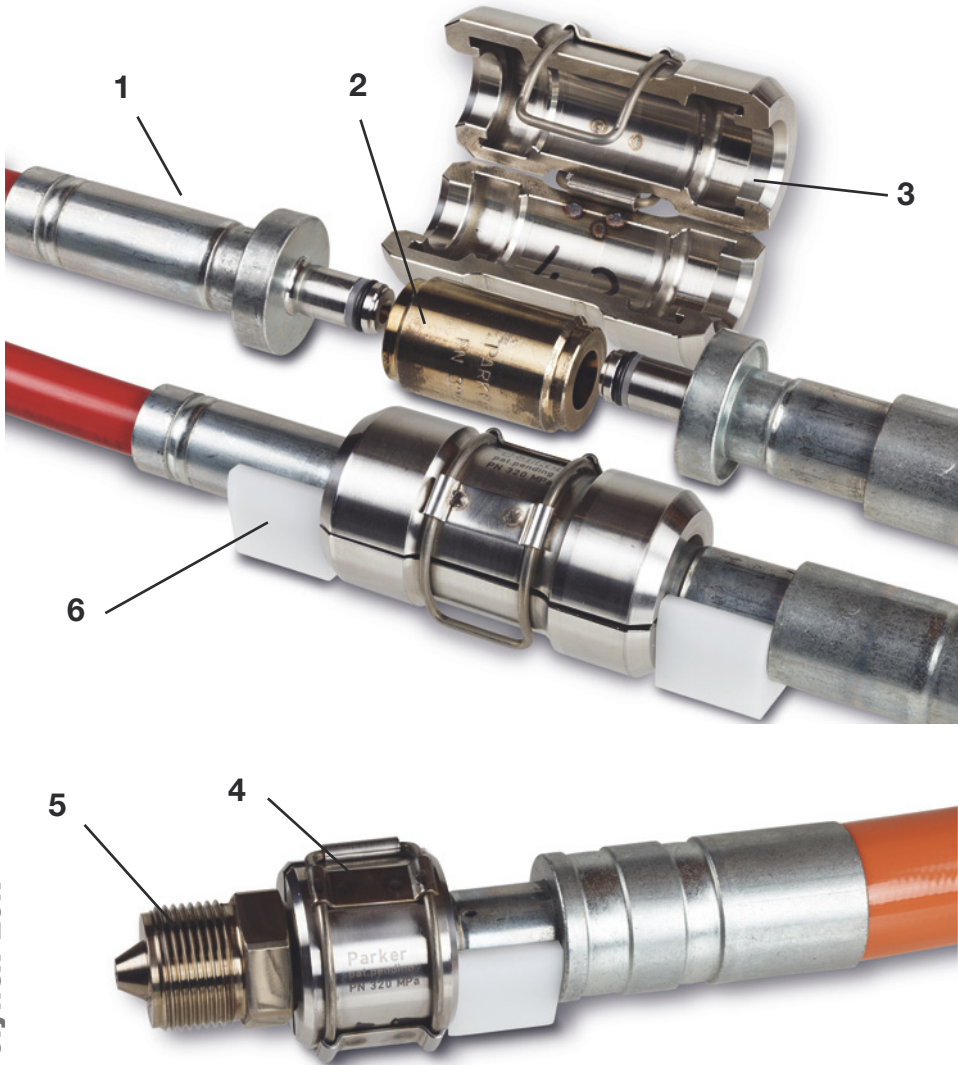

Polyflex-Lok

Ref.	#	Description
1	1TM2X-8-05-HPK	Fitting for DN8 hoses incl. caps
	1TM2X-8-03-HPK	Fitting for DN5 hoses incl. caps
2	TFTF-8-8	Hose connector bushing
3	HPK-HS-8	Hose connector
4	HPK-HSP-8	Pump/gun connector
5	YTTF-6-8	Adapter M20 x 1.5
	YTTF-9-8	Adapter M26 x 1.5
	YTTF-10-8	Adapter M30 x 2
	Y6TF-6-8	Adapter 3/4 - 16UNF
	Y6TF-9-8	Adapter 1 1/8 - 12UNF
6	TMCAP-8	Cap

Chapter H**Quick couplers****Rogan series —****30,000 psi maximum working pressure**

HP006 Coupler.....	H-3
HP006 Nipple (without check valve)	H-4
HP006 Nipple (with check valve).....	H-5
HP010 Coupler.....	H-6
HP010 Nipple (without check valve)	H-7
HP010 Nipple (with check valve).....	H-8

C Series hydraulic couplers —**29,800 psi maximum working pressure**

115 Coupler.....	H-10
115 Nipple.....	H-11
116 Coupler.....	H-12
116 Nipple.....	H-13
125 Coupler.....	H-13
125 Nipple.....	H-14
Adapters.....	H-15

WB Series

125 Coupler.....	H-17
125 Nipple.....	H-17

Rogan series

Scope

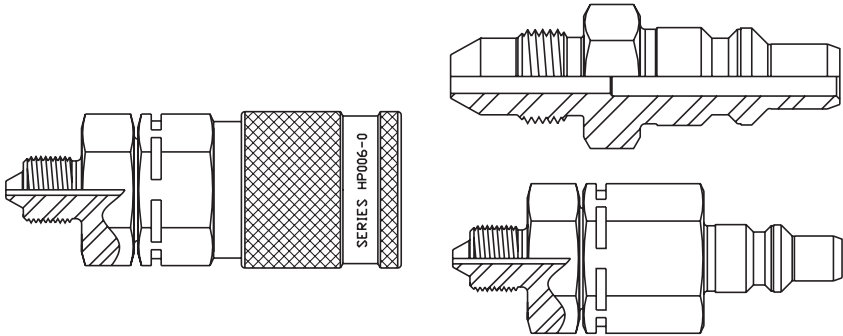

A versatile connecting device that permits easy and rapid joining of hose assemblies to your system. Each coupling is assembled and pressure tested to at least 5,000 psi above its maximum rated working pressure. Couplings with check-valve can withstand the full working pressure in the disconnected condition.

Types and pressures

Type	Max. working pressure (psi/MPa)	Test pressure (psi/MPa)	Nominal thru hole diameter (inch/mm)
HP006	30,000 / 206.8	35,000 / 241.3	0.24 / 6.1
HP010	20,000 / 137.9	25,000 / 172.4	0.40 / 10.2

NOTE: The choice of the threaded end form may limit the working pressure and the size of the thru hole in the coupling. Call **polyflex** for additional information.

HP006 – Coupler

#		A			
		inch mm	inch mm	inch mm	psi MPa
HP006-0-A9	Type "M" (9/16" - 18 threads)	3.30 83.8	1.19 30.2		30,000 206.8
HP006-0-A12	Type "M" (3/4" - 16 threads)	3.34 84.8	1.19 30.2		30,000 206.8
HP006-0-HM4	1/4" High pressure male	3.46 87.9	1.19 30.2		30,000 206.8
HP006-0-HM9	9/16" High pressure male	3.70 94.9	1.19 30.2		30,000 206.8
HP006-0-LM6	3/8" Medium pressure male	3.54 89.9	1.19 30.2		20,000 137.9
HP006-0-NFB	1/4" NPT Female	3.30 83.8	1.19 30.2		15,000 103.4
HP006-0-NFC	3/8" NPT Female	3.30 83.8	1.19 30.2		15,000 103.4
HP006-0-NMB	1/4" NPT Male	3.40 86.4	1.19 30.2		15,000 103.4
HP006-0-NMC	3/8" NPT Male	3.30 83.8	1.19 30.2		15,000 103.4
HP006-0-NMD	1/2" NPT Male	3.45 87.6	1.19 30.2		15,000 103.4
HP006-0-X13	Low angle face seal (9/16" - 18 threads)	3.37 85.6	1.19 30.2		30,000 206.8

Quick couplers

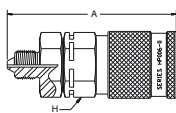

HP006-0-HM4

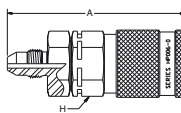

HP006-0-LM6

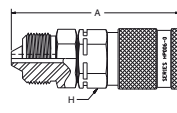

HP006-0-HM9

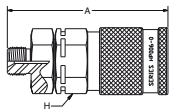

HP006-0-A9
HP006-0-A12

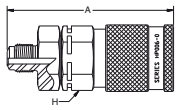

HP006-0-X13

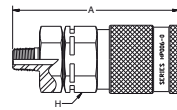

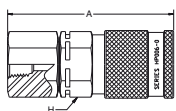

HP006-0-NMB
HP006-0-NMC
HP006-0-NMD



HP006-0-NFB
HP006-0-NFC

HP006 – Nipple without check valve

#		A		
		inch mm	inch mm	psi MPa
HP006-1-A9	Type "M" (9/16" - 18 threads)	1.98 50.3	0.75 19.1	30,000 206.8
HP006-1-A12	Type "M" (3/4" - 16 threads)	2.16 54.9	0.87 22.1	30,000 206.8
HP006-1-HM4	1/4" High pressure male	2.25 57.2	0.75 19.1	30,000 206.8
HP006-1-LM6	3/8" Medium pressure male	2.33 59.2	0.75 19.1	20,000 137.9
HP006-1-LM9	9/16" Medium pressure male	2.57 65.3	1.00 25.4	20,000 137.9
HP006-1-NMB	1/4" NPT Male	2.09 53.1	0.75 19.1	15,000 103.4
HP006-1-NMC	3/8" NPT Male	2.13 54.1	0.75 19.1	15,000 103.4
HP006-1-NMD	1/2" NPT Male	2.31 58.7	1.00 25.4	15,000 103.4
HP006-1-X13	Low angle face seal (9/16" - 18 threads)	2.17 55.1	0.75 19.1	30,000 206.8

Quick couplers

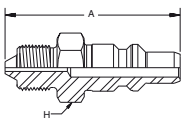

HP006-1-HM4

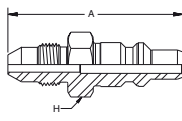

HP006-1-LM6
HP006-1-LM9

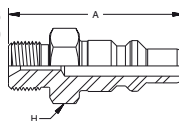

HP006-1-A9
HP006-1-A12

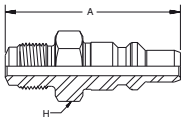

HP006-1-X13

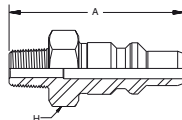

HP006-1-NMB
HP006-1-NMC
HP006-1-NMD

HP006 – Nipple with check valve

#		A		
			inch mm	inch mm
HP006-2-A9	Type "M" (9/16" - 18 threads)	3.28	1.19	30,000
		83.3	30.2	206.8
HP006-2-A12	Type "M" (3/4" - 16 threads)	3.30	1.19	30,000
		83.8	30.2	206.8
HP006-2-HM4	1/4" High pressure male	3.45	1.19	30,000
		87.6	30.2	206.8
HP006-2-LM6	3/8" Medium pressure male	3.52	1.19	20,000
		89.4	30.2	137.9
HP006-2-NFB	1/4" NPT Female	3.26	1.19	15,000
		82.8	30.2	103.4
HP006-2-NFC	3/8" NPT Female	3.25	1.19	15,000
		82.6	30.2	103.4
HP006-2-NMB	1/4" NPT Male	3.34	1.19	15,000
		84.8	30.2	103.4
HP006-2-NMC	3/8" NPT Male	3.34	1.19	15,000
		84.8	30.2	103.4
HP006-2-NMD	1/2" NPT Male	3.43	1.19	15,000
		87.1	30.2	103.4
HP006-2-X13	Low angle face seal (9/16" - 18 threads)	3.35	1.19	30,000
		85.1	30.2	206.8

Quick couplers

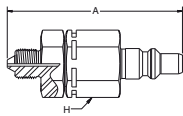

HP006-2-HM4

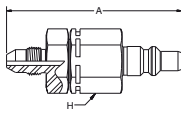

HP006-2-LM6

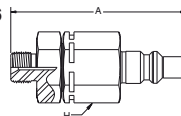

HP006-2-A9
HP006-2-A12

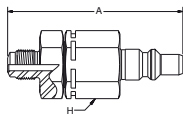

HP006-2-X13

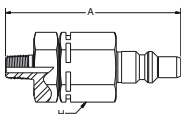

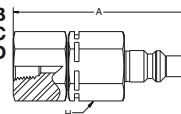

HP006-2-NMB
HP006-2-NMC
HP006-2-NMD

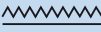

HP006-2-NFB
HP006-2-NFC

HP010 – Coupler

#		A		
		inch mm	inch mm	psi MPa
HP010-0-A12	Type "M" (3/4" - 16 threads)	4.00 101.6	1.62 41.1	20,000 137.9
HP010-0-A16	Type "M" (1" - 12 threads)	4.10 104.1	1.62 41.1	20,000 137.9
HP010-0-LM12	3/4" Medium pressure male	4.64 117.9	1.62 41.1	20,000 137.9
HP010-0-NFD	1/2" NPT Female	4.27 108.5	1.62 41.1	15,000 103.4
HP010-0-NMD	1/2" NPT Male	4.13 104.9	1.62 41.1	15,000 103.4
HP010-0-X23	Low angle face seal (3/4" - 16 threads)	4.19 106.4	1.62 41.1	20,000 137.9

Quick couplers

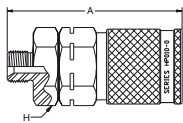

HP010-0-A12
HP010-0-A16

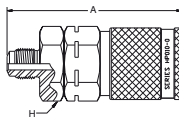

HP010-0-X23

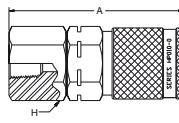

HP010-0-NFD

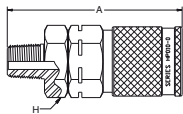

HP010-0-NMD

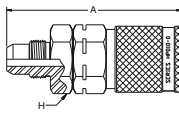

HP010-0-LM12

HP010 – Nipple without check valve

#		A			
		inch mm	inch mm		
HP010-1-A12	Type "M" (3/4" - 16 threads)	2.40 61.0	1.06 26.9	20,000 137.9	
HP010-1-A16	Type "M" (1" - 12 threads)	2.53 64.3	1.18 30.0	20,000 137.9	
HP010-1-LM9	9/16" Medium pressure male	3.12 79.2	1.18 30.0	20,000 137.9	
HP010-1-LM12	3/4" Medium pressure male	2.84 72.1	1.06 26.9	20,000 137.9	
HP010-1-NMD	1/2" NPT Male	2.52 64.0	1.06 26.9	15,000 103.4	
HP010-1-X23	Low angle face seal (3/4" - 16 threads)	2.58 65.5	1.06 26.9	20,000 137.9	

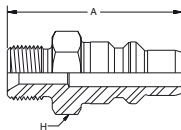

HP010-1-A12
HP010-1-A16

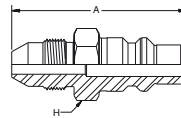

HP010-1-LM9
HP010-1-LM12

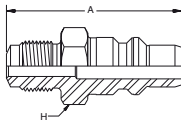

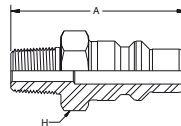

HP010-1-X23



HP010-1-NMD

HP010 – Nipple with check valve

#		A		
		inch mm	inch mm	psi MPa
HP010-2-A12	Type "M" (3/4" - 16 threads)	4.00 101.6	1.62 41.1	20,000 137.9
HP010-2-A16	Type "M" (1" - 12 threads)	4.08 103.6	1.62 41.1	20,000 137.9
HP010-2-NFD	1/2" NPT Female	4.14 105.2	1.62 41.1	15,000 103.4
HP010-2-NMD	1/2" NPT Male	4.13 104.9	1.62 41.1	15,000 103.4
HP010-2-X23	Low angle face seal (3/4" - 16 threads)	4.18 106.2	1.62 41.1	20,000 137.9

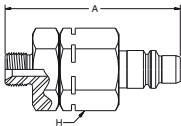

HP010-2-A12
HP010-2-A16

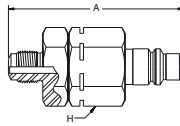

HP010-2-X23

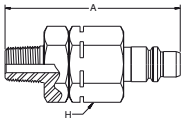

HP010-2-NMD

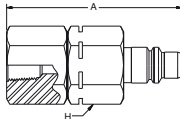

HP010-2-NFD

C series

Applications

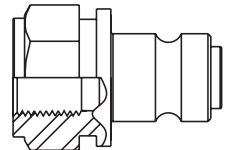
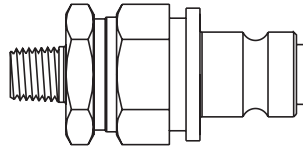
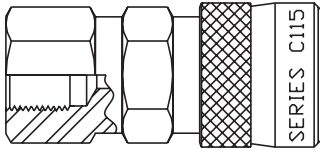

- Torque Tensioning
- Stud Tensioning
- Rescue
- Bearing Pullers
- Intensifiers
- Hydrostatic Testing
- Pumps
- Jacks
- Spreaders
- Cable Cutters
- Nut Splitters
- Pipe Coupling Swagers
- Presses
- Clamping Fictures
- Crimpers
- Blow-out Preventers

Features



- Working pressures to 29,000 psi.
- Non-drip valving for clean, safe, trouble-free performance and minimal air inclusion.
- Built-in safety locking device to prevent accidental disconnect.
- Wide range of threaded styles NPT, BSP and “High Pressure”.
- Adaptors for ease of connection to high pressure hoses and fixed ports.
- Thread sizes from 1/8" to 3/8"
- Protective dust caps are included to prevent damage and fluid contamination in disconnected position.
- Rugged design and construction for long life in demanding applications.

Types and pressures

Type	Max. working pressure (psi/MPa)	Test pressure (psi/MPa)	Nominal thru hole diameter (inch/mm)
C Series 115	14,500 / 100.0	21,800 / 150.3	0.11 / 2.8
C Series 116	21,800 / 150.3	29,200 / 201.3	0.11 / 2.8
C Series 125	29,800 / 205.5	36,300 / 250.3	0.11 / 2.8

NOTE: The choice of the threaded end form may limit the working pressure and the size of the thru hole in the coupling.

115 – Coupler

#		A		
		inch mm	inch mm	psi MPa
C10-115-1202	1/4" BSP Female (thru type)	2.30 58.4	0.94 23.9	14,500 100.0
C10-115-1222	1/4" BSP Female (with built-in locking device)	2.30 58.4	0.94 23.9	14,500 100.0
C10-115-1401	1/8" NPT Female	2.30 58.4	0.94 23.9	14,500 100.0
C10-115-1402	1/4" NPT Female	2.30 58.4	0.94 23.9	14,500 100.0
C10-115-1404	3/8" NPT Female	2.38 60.5	0.94 23.9	14,500 100.0
C10-115-1422	1/4" NPT Female (with built-in locking device)	2.30 58.4	0.94 23.9	14,500 100.0
C10-115-1452	1/4" NPT Male	2.45 62.2	0.94 23.9	14,500 100.0
C10-115-1454	3/8" NPT Male	2.45 62.2	0.94 23.9	14,500 100.0

Quick couplers

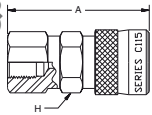

C10-115-1202

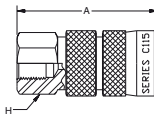

C10-115-1222

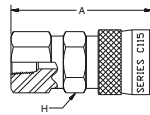

C10-115-1401

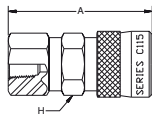

C10-115-1402

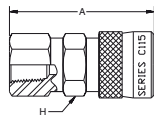

C10-115-1404

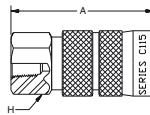

C10-115-1422

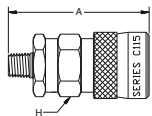

C10-115-1452

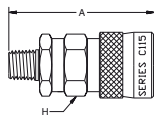



C10-115-1454

115 – Nipple

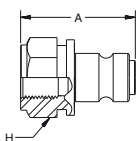
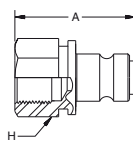
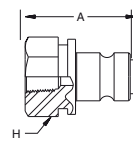
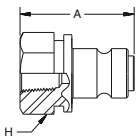
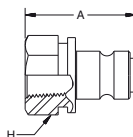
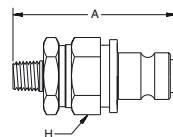
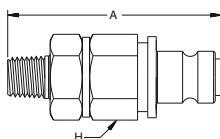
#		A		
			inch mm	inch mm
C10-115-6202	1/4" BSP Female	1.47 37.3	0.87 22.1	14,500 100.0
C10-115-6204	3/8" BSP Female	1.56 39.6	0.94 23.9	14,500 100.0
C10-115-6401	1/8" NPT Female	1.42 37.3	0.87 22.1	14,500 100.0
C10-115-6402	1/4" NPT Female	1.42 37.3	0.87 22.1	14,500 100.0
C10-115-6404	3/8" NPT Female	1.46 37.1	0.94 23.9	14,500 100.0
C10-115-6452	1/4" NPT Male	2.40 61.0	0.87 22.1	14,500 100.0
C10-115-6454	3/8" NPT Male	2.55 64.8	0.94 23.9	14,500 100.0



C10-115-6202

C10-115-6204

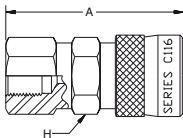
C10-115-6401

C10-115-6402

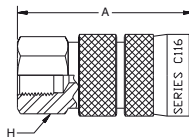
C10-115-6404

C10-115-6452

C10-115-6454
Quick couplers

116 – Coupler

#		A		
		inch mm	inch mm	psi MPa
C10-116-1202	1/4" BSP Female	2.30 58.4	0.94 23.9	21,800 150.3
C10-116-1222	1/4" BSP Female (with built-in locking device)	2.30 58.4	0.94 23.9	21,800 150.3
C10-116-1402	1/4" NPT Female	2.30 58.4	0.94 23.9	15,000 103.4
C10-116-1422	1/4" NPT Female (with built-in locking device)	2.30 58.4	0.94 23.9	15,000 103.4



C10-116-1202



C10-116-1222

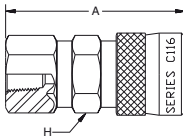

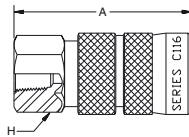

C10-116-1402

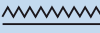

C10-116-1422

116 – Nipple

#		A			
		inch mm	inch mm		
C10-116-5202	1/4" BSP Female (thru type)	1.47 37.3	0.87 22.1	21,800 150.3	
C10-116-6202	1/4" BSP Female	1.47 37.3	0.87 22.1	21,800 150.3	
C10-116-6402	1/4" NPT Female	1.41 35.8	0.87 22.1	15,000 103.4	

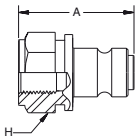

C10-116-5202

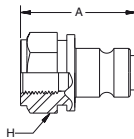

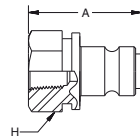

C10-116-6202



C10-116-6402

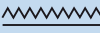

125 – Coupler

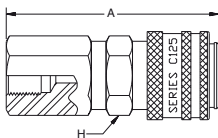
#		A			
		inch mm	inch mm		
C10-125-1202	1/4" BSP Female	2.65 67.3	0.94 23.9	29,000 199.9	

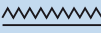

C10-116-5202

125 – Nipple

#		A		
		inch mm	inch mm	psi MPa
C10-125-5202	1/4" BSP Female (thru type)	1.50 38.1	0.87 22.1	29,000 199.9
C10-125-6202	1/4" BSP Female	1.50 38.1	0.87 22.1	29,000 199.9

Quick couplers

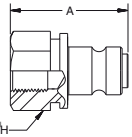

C10-125-5202
 C10-125-6202

Quick coupling adapters

#		A		
			inch mm	inch mm
C09-125-1680	1/4" BSP 120° external cone x 1/4" H.P. male	1.72 43.7	0.67 17.0	14,500 100.0
C19-950-0029	1/4" BSP 120° ext. cone x 9/16" UNF hose	1.48 37.6	0.67 17.0	14,500 100.0
C19-950-0062	1/4" BSP rubber metal seal	0.08 2.0	0.81 20.6	14,500 100.0
C19-950-0064	3/8" BSP rubber metal seal	0.08 2.0	0.94 23.9	14,500 100.0
C19-950-1600	1/4" BSP 120° external cone blind plug	1.07 27.2	0.67 17.0	14,500 100.0
C19-950-1601	1/4" BSP x 1/4" BSP with 120° external cones	1.76 44.7	0.83 21.1	14,500 100.0
C19-950-1602	1/4" BSP 120° ext. cone x 1/4" BSP 60° int. cone	1.54 39.1	0.83 21.1	14,500 100.0
C19-950-1622	1/4" BSP x 1/4" BSP with 60° internal cones	1.25 31.8	0.83 21.1	14,500 100.0
C19-950-1623	1/4" NPT Male x 1/4" BSP with 60° internal cone	1.27 32.3	0.83 21.1	14,500 100.0
C19-950-1680	Porting block	1.80 45.7		14,500 100.0
HAHM4BM4	1/4" BSP with 60° internal cone x 1/4" H.P. Male	1.47 37.3	0.83 21.1	14,500 100.0

Quick couplers

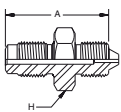
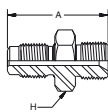
C09-125-1680

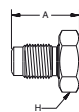
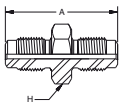
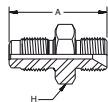
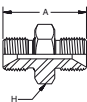
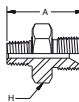
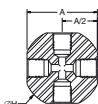
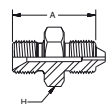
C19-950-0029

**C19-950-0062
C19-950-0064**

C19-950-1600

C19-950-1601

C19-950-1602

C19-950-1622

C19-950-1623

C19-950-1680

HAHM4BM4

WB series

Applications



Parker's WB Series couplings are designed for equipment used in cleaning applications such as paint removal or mill scale. The 10,000 psi operating pressure of the WB series makes it ideal for applications that require a high pressure coupling with minimal pressure drop.



Features

- Push-to-Connect allows for quick, easy connections by eliminating the need to retract the sleeve to couple.
- Locking collets in the female half maintain 360 degree contact with male half to evenly distribute load and reduce brinelling.
- Zinc plating with yellow chromate finish resists corrosion.
- Straight through design allows for excellent flow with low pressure drop.
- Two knurled bands on the sleeve provide good gripping for operation of sleeve to disconnect.
- Sleeve Lock design prevents accidental disconnects.
- Stainless steel collets resist corrosion and provide smooth latching action.
- Teflon® backup washer ensures sealing integrity at high pressure.
- Induction hardened locking groove on the male half reduces wear and brinelling.
- Sleeve guard prevents accidental disconnect and seals the opening between the sleeve and the body from the environment.

Specifications

Body size	Temperature range	Max. working pressure	Rated flow
1/2"	-40 °F to +250 °F (-40 °C to +121 °C)	10,000 psi (69 MPa)	45 GPM (170 LPM)

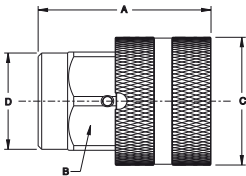

125 – WB coupler

#		A		C	D	
		inch mm	inch mm	inch mm	inch mm	psi MPa
WB-501-8FP	1/2-14 NPTF	2.10 53.3	1.25 31.8	1.25 31.8	1.25 31.8	10,000 68.9



WB-501-8FP

125 – WB nipple

#		A		C	D	
		inch mm	inch mm	inch mm	inch mm	psi MPa
WB-502-8FP	1/2-14 NPTF	2.35 59.7	1.26 32.0	1.13 28.7	1.63 41.4	10,000 68.9

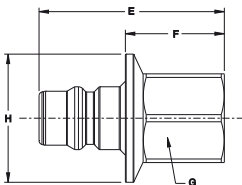

WB-502-8FP



Chapter I

Accessories

Heavy duty abrasion cover	I-2
Heavy duty abrasion cover sleeves	I-2
Spring guards.....	I-3
Support grips	I-3
PVC-S – Anti-abrasion sleeve.....	I-4
HS - Containment grips	I-4
UHPLABEL – Precautions for ultra-high pressure applications	I-4

Heavy duty abrasion cover



#	Description
MHDC010	5/8" I.D. Clear Vinyl
MHDC011	5/8" I.D. Clear Vinyl with white Helix reinforcement
MHDC012	3/4" I.D. Clear Vinyl with white Helix reinforcement
MHDC014	7/8" I.D. Clear Vinyl with white Helix reinforcement
MHDC016	1" I.D. Clear Vinyl with white Helix reinforcement
MHDC018	1-1/8" I.D. Clear Vinyl with white Helix reinforcement
MHDC020	1-1/4" I.D. Clear Vinyl with white Helix reinforcement
MHDC022	1-3/8" I.D. Clear Vinyl with white Helix reinforcement
MHDC024	1-1/2" I.D. Clear Vinyl with white Helix reinforcement
MHDC026	1-5/8" I.D. Clear Vinyl with white Helix reinforcement
MHDC032	2" I.D. Clear Vinyl with white Helix reinforcement

Heavy duty abrasion cover sleeves



#	Description
508-J-500-10	MHDC010, MHDC011
510-A-500-12	MHDC012
612-400-14	MHDC014
216-200-18	MHDC016, MHDC018
620-100-18	MHDC018 (w/2640N-08 hose)
220-200-22	MHDC022, MHDC024
520-A-500-26	MHDC026

Spring guards



#	Description
MSG060	0.60" I.D. Continuous Spring
MSG1006	For 2040N-04V00 Hose
MSG2006	For 2245N-04V00 Hose
MSG2106	For 2380N-04v00 Hose
MSG4113	For -8 Hoses
MSG4120	For 2440n-12V37 Hose
MSG4125	For 2440N-16V37 Hose
MSG6020	For 2640N-12v32 Hose

Support grips

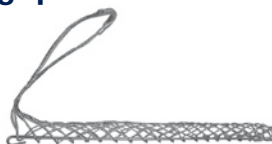

#	Description
MK022-03-038	For Hose O.D. 0.63" - 0.74"
MK022-03-039	For Hose O.D. 0.75" - 0.99"
MK022-03-041	For Hose O.D. 1.00" - 1.24"
MK022-03-042	For Hose O.D. 1.25" - 1.49"
MK022-03-043	For Hose O.D. 1.50" - 1.74"
MK022-03-045	For Hose O.D. 2.25" - 2.49"

PVC-S - Anti-abrasion sleeve

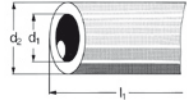

COLOUR Yellow

NOTE As an alternative, rubber anti-abrasion sleeves are available

#		For hose				Diameter in mm		Hose type	Mountable Length in m
Protective sleeve	Clamp ferrule	DN	size	mm	inch	d1	d2		l1
PVC-S-03	KL-03	5	-03	4.8	3/16	22	28	2640D-03	20/40
PVC-S-05	KL-05	8	-05	7.9	5/16	27	33	2640D-05	20/40
PVC-S-08	KL-08	12	-08	12.7	1/2	35	45	2640N-08	20
PVC-S-12	KL-12	20	-12	19.0	3/4	40	50	2640N-12	20
PVC-S-16	KL-16	25	-16	25.4	1	55	65	2640N-16	20

HS - Containment grips

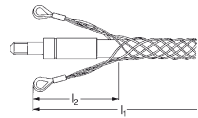

MATERIAL electrogalvanized steel wire

NOTE *F-KN 3/9: working load 3 KN, breaking load 9 KN, e.g. DN5

#	For hose						Total Length	Length of Loops in mm
Protective sleeve	DN	size	mm	inch	Ø mm	F-KN*	l1	l2
HS-03	5	-03	4.8	3/16	9-15	3/9	600	200
HS-05	8	-05	7.9	5/16	15-20	6/18	600	200
HS-08	12	-08	12.7	1/2	20-30	11/33	600	200
HS-12	20	-12	19.0	3/4	30-40	11/33	600	200
HS-16	25	-16	25.4	1	40-50	16/48	600	200

UHPLABEL – Precautions for ultra-high pressure applications



MATERIAL self-adhesive PE sticker

#	Dimensions
UHPLABEL	60 x 250 mm

Chapter J**Technical information**

Installation tips	J-2
Selection, installation, and maintenance of polyflex hose and hose assemblies	J-3
Dash sizes	J-4
Selection of hose diameter from flow rate and velocity	J-5
Determination of Pressure Drop in the Line	J-6
Pressure drop	J-7
Glossary	J-12
Permeability coefficient	J-14
Recommended tightening procedures	J-15
Metric conversion chart	J-16
General chemical resistance table	J-17
Parker safety guide	J-21

Installation tips

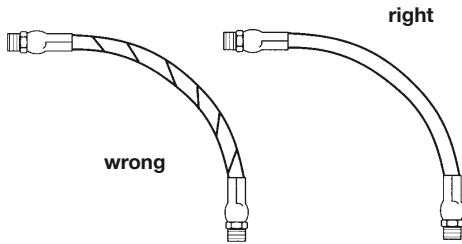

Hose is weakened when installed in twisted position. Also, pressure pulses in twisted hose tend to fatigue wire and loosen fitting connections. Design so that machine motion produces bending rather than torsion.

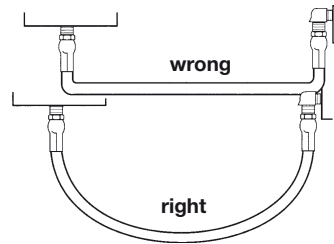

Hose should exit coupling in a straight position rather than side loaded. The minimum bend radius must not be exceeded to avoid kinking of hose and flow restriction.

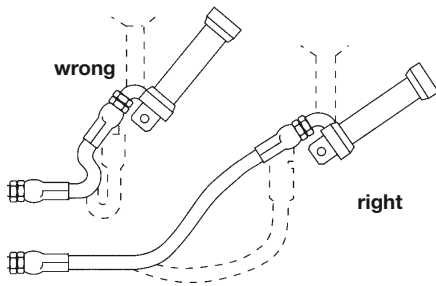

When hose assembly is installed in a flexing application, remember that metal hose fittings are not part of the flexible portion.

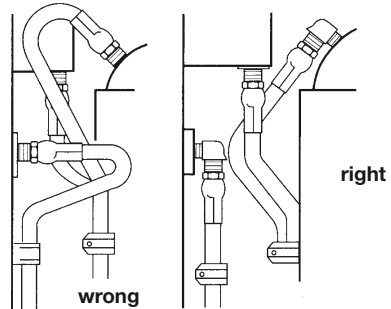

Use elbows or adaptors as necessary to eliminate excess hose length and to ensure neater installation and easier maintenance.

Free hose length allowance:

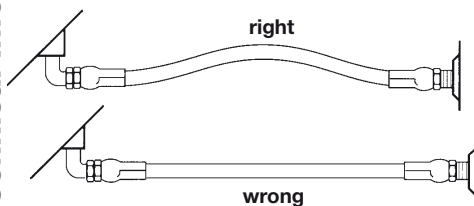

Pressure can change hose in length by as much as $\pm 2\%$. This must be considered when cutting hose to appropriate length.

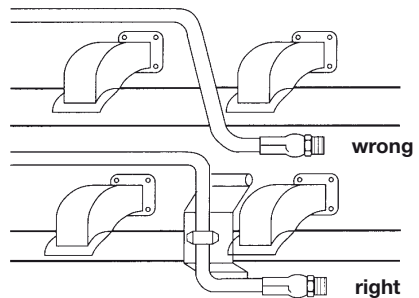

Avoid installing hose assemblies close to heat sources. However, if this should be required, insulate hose.



Selection, installation, and maintenance of *polyflex* hose and hose assemblies

Hose and hose assemblies have a finite life span and many factors can reduce this time. This recommended practice should be read by designers and users of hose to assist them in the proper selection of hose. These guidelines, while not exhaustive, will assist the user in maintaining hydraulic and pneumatic systems.

READ THE PARKER SAFETY GUIDE CONTAINED IN THIS CATALOGUE IN ITS ENTIRETY.

PART 1 - How to select hose

- **Pressure** - Maximum operating pressure of the hose must be greater than or equal to the system pressure. Pressure surges or system “spikes” in excess of the maximum operating pressure will shorten hose life and must be avoided.
- **Temperature** - Ambient and fluid temperatures must not exceed the hose/fittings rated design temperature. Attempt to route hose or shield hose from high temperature sources.
- **Size** - Adequately size hose and fittings to avoid damaging hose with excessive turbulence, or heat build-up, while maintaining proper flow and pressure. (Refer to fluid velocity nomogram.)
- **Fluid Compatibility** - Refer to Chemical Compatibility Guide in this catalog for use of fluids with various materials. If unsure of an application, contact the factory. Additional care must be taken with gaseous applications. (See Safety Guide at end of catalog.)
- **Environment**- Conditions such as ozone, UV light, harsh chemicals, salt water, and other airborne contaminants can degrade hose and shorten its life.
- **Length** - Hose length changes with pressure. This, along with equipment movement, must be considered in the system design.
- **Proper couplings** - Always follow manufacturers specifications and do not mix components of different manufacturers.
- **Mechanical loads** - Conditions such as tensile and side loads, vibration, excessive flexing, and twist will reduce hose life. Use swivel fittings and adaptors to avoid hose twisting. Test the hose if the application is potentially problematic or unusual.
- **Electrical conductivity** - Determine if the hose must be non-conductive to prevent electrical current flow or conductive to dissipate static electricity. Choose hose and fittings accordingly. (See Safety Guide for Electrical Conductivity issues.)

PART 2 - Installation and maintenance

- **Inspect components** - Check hose for cover cracks, blisters, cleanliness, kinks, cracks or core tube obstructions or other defects. Examine fittings for poor threads, obstructions, cracks, rust. Do not use hose or fittings if these problems exist.
 - **Assemble per instructions** - Instructions are available for companies, trained and authorized by Polyflex.
 - **Do not exceed specified minimum bend radius** - Use stress relievers to prevent sharp bends at the hose and fitting juncture. These can be spring guards or other stress relieving members.
 - **Ensure that hose bends rather than twists with equipment motion.**
 - **Use a torque wrench or the flats from finger tight method to properly install port connections.**
 - **After installation, eliminate air entrapped in system, pressurise to maximum operating pressure, and check for leaks and proper system function.**
 - **After installation, periodically (frequency depends on severity of application and potential risk) inspect the system for the following:**
 1. Blistered, degraded, or loose hose covers.
 2. Stiff, cracked, or charred hose.
 3. Cuts or abrasion of hose. Look for exposed reinforcement.
 4. Leaks in hose or fittings.
 5. Damaged or corroded fittings.
 6. Excessive build up of dirt, grease, oils, etc.
 7. Defective or broken accessories (clamping devices, kink guards)
 8. Kinks in hoses.
- Upon discovery of any of these items, replace it, repair it, but **DO NOT IGNORE IT!**
- Retest the system after all maintenance procedures.
 - Establish replacement schedules based on previous service life, or when failures could result in damage, personal injury, excessive or unacceptable downtime.

Dash sizes

Dash sizes are commonly used to designate hose I. D., plastic tubing and metal tubing O. D. and coupling size. Dash size systems in common use:

Nominal hose I.D. or tubing O.D.		Dash number for all <i>polyflex</i> hose	Nominal DN size
Inches	Millimeters		
3/32	2.0	-012	2
1/8	3.2	-2	3
5/32	4.0	-025 or 2A	4
3/16	4.8	-3	5
1/4	6.3	-4	6
5/16	7.9	-5	8
3/8	9.5	-6	10
13/32	10.3	-6.5	–
1/2	12.7	-8	12
5/8	15.9	-10	16
3/4	19.1	-12	20
7/8	22.2	-14	–
1	25.4	-16	25
1-1/8	28.6	–	–
1-1/4	31.8	-20	32
1-3/8	34.9	–	–
1-1/2	38.1	-24	40
1-13/16	46.0	–	–
2	50.8	-32	50

Selection of hose diameter from flow rate and velocity

Volumetric flow Q
 (l/min) Gal/min*

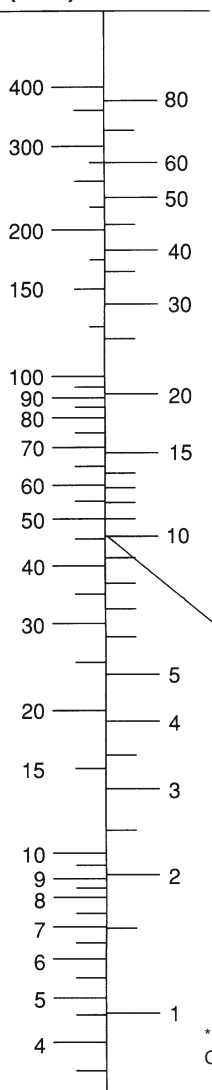

Flow capacities of Parker hose at recommended flow velocities

The chart below is provided as an aid in the determination of the correct hose size.

Example:

at 10 gallons per minute (gal/min), what is the proper hose size within the recommended velocity range for pressure lines?

Locate 10 gallons per minute in the left-hand column and 25 feet per second in the right-hand column (the maximum recommended velocity range for pressure lines).

Lay a straight line across these two points. The inside diameter shown in the centre column is above -6 so we have to use -8 (1/2").

For suction hose, follow the same procedure except use recommended velocity range for intake lines in the right-hand column.

where: Q = flow in gallons per minute (gal/min & l/min)
 V = velocity in feet per second (f/s & m/s)
 d = hose inside diameter (mm & dash size)

Hose inner diameter d
 mm dash sizes

50,8	-32
38,1	-24
31,8	-20
25,4	-16
19,1	-12
15,9	-10
12,7	-8
9,5	-6
7,9	-5
6,3	-4
4,8	-3

Flow velocity v
 (m/s) feet/s



Recommended maximum velocity for suction lines

Recommended maximum velocity for return lines

Recommended maximum velocity for pressure lines

* gallons are UK gallons
 Conversion factors: gal/min x 4.546 = l/min
 feet/s x 0.3948 = m/s

* Recommended velocities are according to hydraulic fluids of maximum viscosity 315 S.S.U. at 38 °C working at roomtemperature within 18 ° and 68 °C.

Determination of pressure drop in the line

Velocity: $v = .409 \frac{Q}{d^2} = .0509 \frac{W}{pd^2} = \frac{q}{.785d^2}$

Reynold's Number: $Re = 124 \frac{dvp}{\mu} = 6.31 \frac{W}{d\mu} = 378 \frac{qp}{d\mu}$

Pressure Drop, Isothermal, Incompressible Flow (Liquids):

$$\Delta P = .001294 \frac{fL p v^2}{d} = .00000336 \frac{fLW^2}{pd^5} = .0121 \frac{fL q^2}{d^5}$$

Pressure Drop, Isothermal, Compressible, Long Lines (Gases and Vapors):

$$\frac{\Delta P}{P_1} = 1 - \sqrt{1 - \frac{fL p_1 v_1^2}{12 g d P_1}}$$

Symbols and Units for Listed Formulas

d = inside diameter of hose, inches

f = friction coefficient, dimensionless

g = gravitational constant, 32.2 ft./sec.²

P1 = input pressure, psi

ΔP = pressure difference, psi

q = rate of flow at flowing condition, cu. ft./min.

Q = rate of flow, gals./min.

Re = Reynolds number, dimensionless

v = flow velocity, ft./sec.

W = rate of flow, lbs./hr.

p = weight density of fluid, lbs./cu. ft.

μ = absolute (dynamic) viscosity, centipoises

Pressure drop

For size -02 (3 mm) hoses

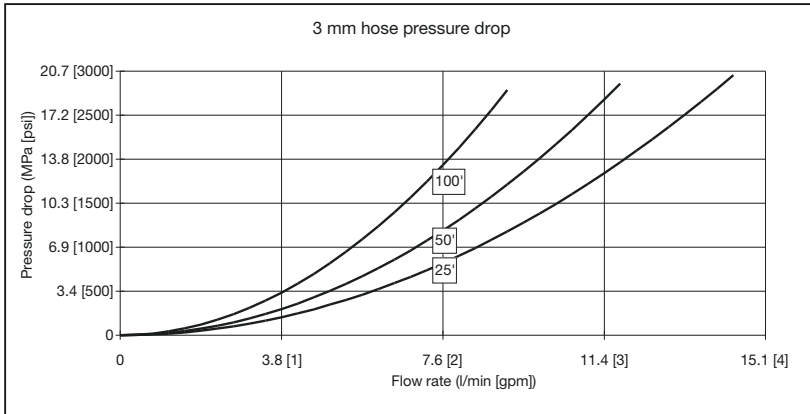

For size -025 (4 mm) hoses

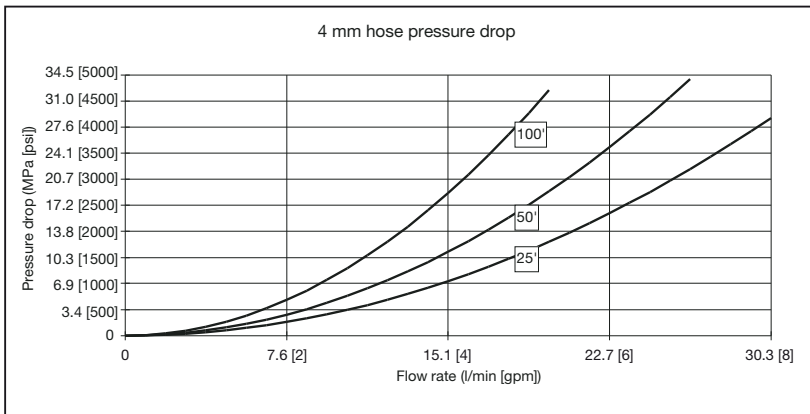

Results obtained from actual pressure drop tests, pumping water through hose assemblies with normal end fittings.

For size -03 (5 mm) hoses

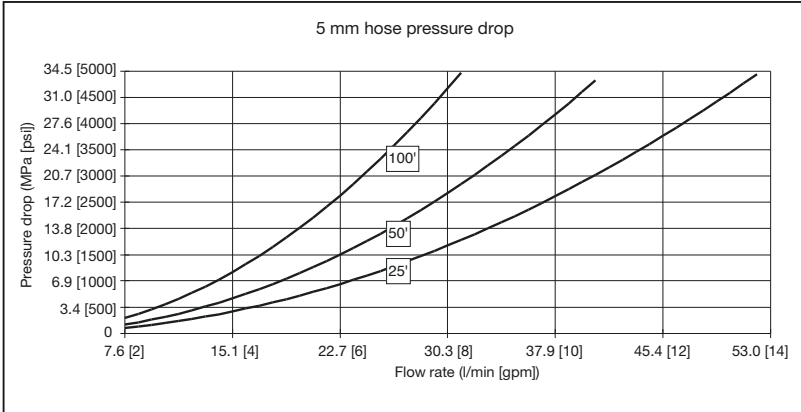

**For Hose:
 2840D-03**

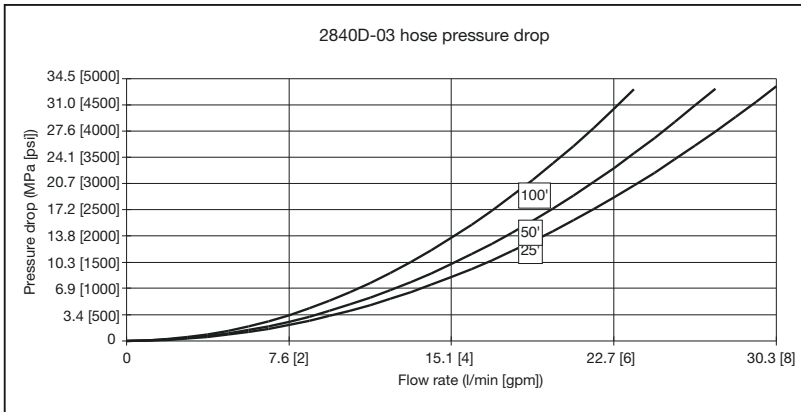

Results obtained from actual pressure drop tests, pumping water through hose assemblies with normal end fittings.

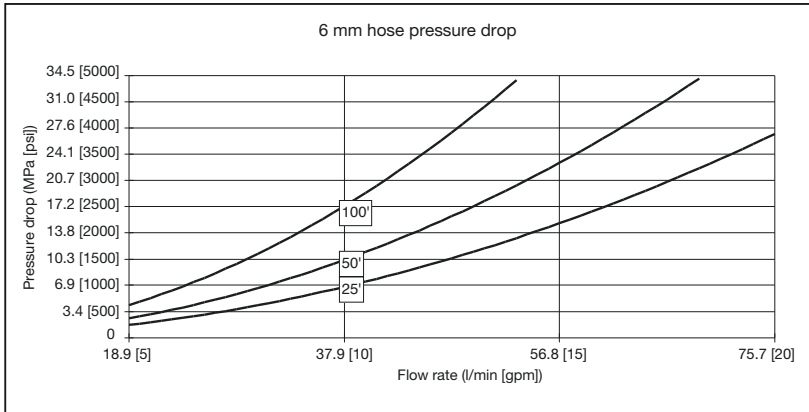
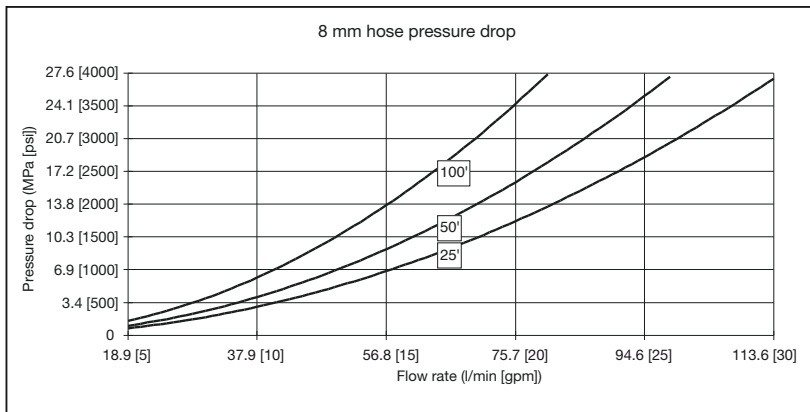
For size -04 (6 mm) hoses**For size -05 (8 mm) hoses**

Results obtained from actual pressure drop tests, pumping water through hose assemblies with normal end fittings.

For size -06 (10 mm) hoses

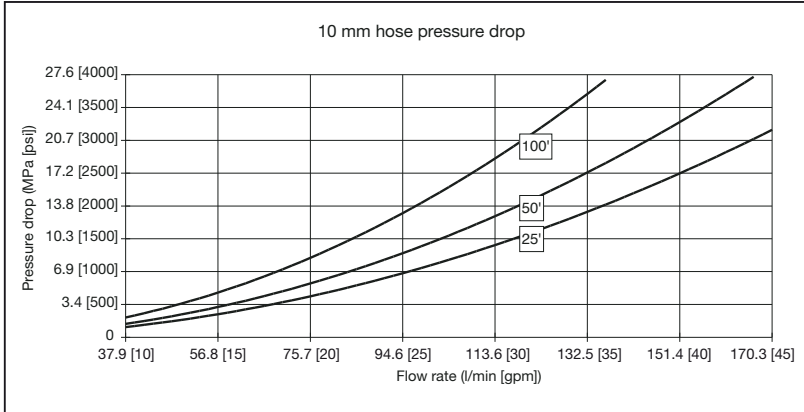

For size -08 (13 mm) hoses

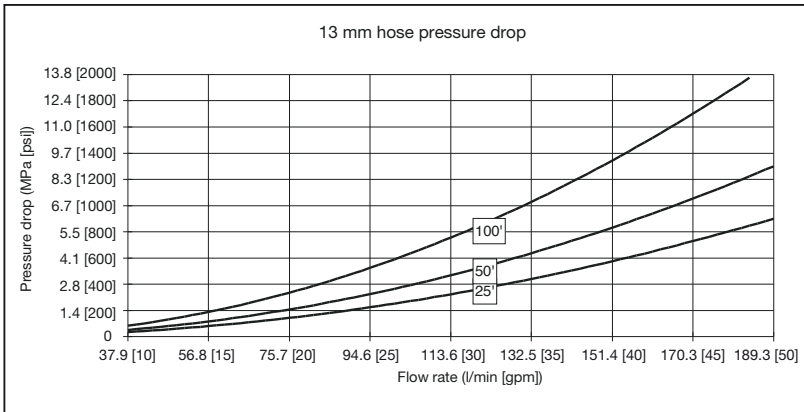

Results obtained from actual pressure drop tests, pumping water through hose assemblies with normal end fittings.

For size -12 (20 mm) hoses

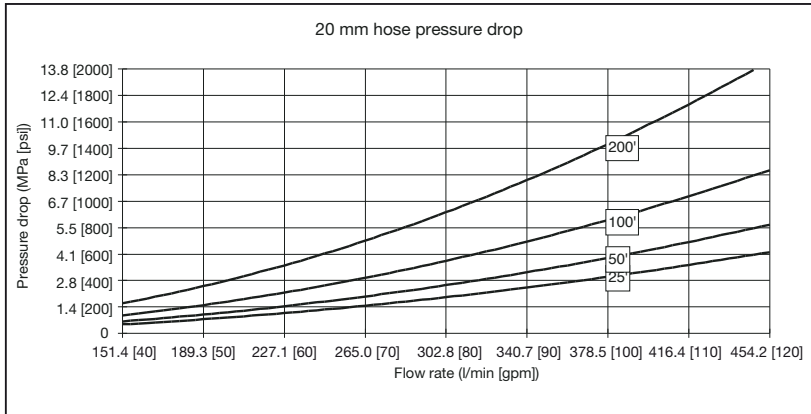

For size -16 (25 mm) hoses

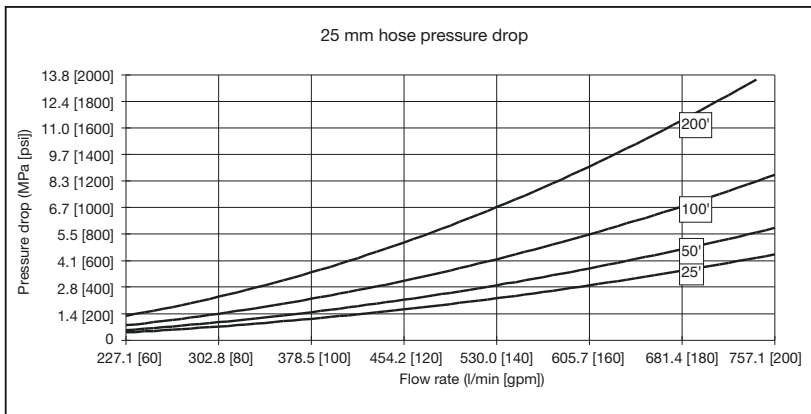

Results obtained from actual pressure drop tests, pumping water through hose assemblies with normal end fittings.

Glossary

Abrasion

Abrasion occurs in numerous forms; two of the more common are the typical rubbing or chafing, with the second being very high frequency, low amplitude friction. This type of abrasion results from pump pressure pulses otherwise known as pump ripple. It can also be caused by equipment vibration or resonance. Abrasion may occur when two hose lines cross or when a hose line rubs or bears against a fixed point. Abrasion resistance is also a function of temperature and attack of the cover material by aggressive chemicals. Spring guards or other protective sleeving can also ward off premature hose failure resulting from abrasion. Spring guards also distribute bending force often associated with excessive side loading or even kinking at the skirt of the coupling.

Ambient temperature

Exceedingly high or low ambient temperatures will affect the materials from which the hose is constructed and will negatively influence hose life. When at all possible, the hose should be routed in such a manner as to protect it from heat sources. In extreme cold applications, the equipment should be designed with remote relief valves to allow circulation and warming of the oil before hose articulation is attempted. The hose liner (core tube) of choice for extremely high or low temperature is Teflon®. Teflon® is serviceable at temperatures as low as -100°F and as high as +450°. Consult the specific hose operating parameters for more information.

Bend radius

The minimum bend radii listed in this catalog are valid at rated working pressures and indicated service temperatures. Service life of a hose may be shortened if the minimum radius is exceeded or if the hose is flexed continuously in use.

Burst pressure and working pressure

The specified burst pressure for each hose style and dash size are for unaged hoses tested at normal laboratory temperature in accordance with SAE J343 specification for normal service and technically ideal installations. The maximum recommended working pressure is 1/4 of the mini-

mum rated burst pressure, except as otherwise specifically stated in those product specifications. For more severe service, a higher rated working pressure hose may have to be selected.

Hose installation tips

Establish hose size (I. D.) and style based upon flow rate (GPM), pressure drop, and chemical compatibility with fluid medium. Other significant factors to be considered in hose selection and installation are discussed briefly as follows:

Operating temperature

The temperature range for satisfactory service (maximum hose life) depends to a great extent upon the fluid being conveyed. Use of a hose above maximum specified temperature ratings will shorten hose life due, but not limited, to oxidation, chemical degradation and loss of compression within the coupling.

Pressure effects

Pressure surges and system shocks (spikes) are common in hydraulic systems. The normal 4:1 safety factor should reflect these transient pressures. Where these surges and shocks are considered severe or hazardous, the safety factor should be increased.

When hose is under pressure, it may change in length by as much as $\pm 3\%$. Installation should compensate for shortening by providing an appropriate amount of slack and for lengthening by allowing space for this growth to be absorbed.

Routing and clamping

Whenever possible, and maximum efforts should be made to do so, hose should be routed to flex in a single plane. Routing hoses in flexure through compound bends results in torsions. When this is unavoidable, the torsion should be distributed over the maximum hose length possible. Wire reinforced hoses suffer the most rapid and severe loss of service life when applied in torsion. Extremely tight and improperly located clamps focus this torsion over short distances.

Analysis of the hose function is required before

the proper clamping techniques can be selected. In some applications, hoses must be contained to stay out of harm's way and at the same time be free to come and go with equipment articulation. Other applications may require restrictive clamping, in which case a protective material should be used around the hose to provide the grasp without deformation of the hose by the clamp. These techniques also apply to the use of the popular method of clamping and clustering hoses with plastic tie straps.

Parker swivel adaptors feature 360° swiveling action that especially suits them for use in applications where hose moves, bends or twists. Swivel adapters connected to hose assemblies relieve twisting, prevent excessive flexing of hose, eliminate need for long radius bends, and cushion intraline shock caused by peak system pressure pulses.

High pressure adapters

It is critical that the adapter material be properly suited to the fluid media. Widely varying conditions frequently necessitate high pressure adapters constructed of materials other than conventional 316 stainless steel. Since many variables affect the corrosion resistance of metallic materials, it is Parker Hannifin's policy not to recommend materials based on corrosion resistance for specific fluid applications. The published recommended working pressure represent the capability of the subject fitting. Nevertheless, in some instances, the hose, hose fitting or other connector assembled to the adapter may dictate the maximum working pressure. The end-user should read and understand the Parker Safety Guide (Bulletin 4400-B.1) and follow its suggested practices and warnings.

Permeability coefficient

$$\text{Permeability Coefficient} = \frac{V}{A \times T \times p}$$

- Where: V is the volume of gas, in cm³, which diffuses through a 1mm thickness.
 A is the area across which the gas diffuses, in m².
 T is the diffusion time, in days.
 p is the pressure difference across the plastic, in bar.

Permeability Coefficients per DIN 53380

Material	Gas				
	N ₂	O ₂	CO ₂	H ₂	He
PTFE	50	150	1500	—	3500
PVDF	3	2	10	—	60
PA-6 XE 3289	1	4	10	100*	60*
PA-6 A 28 NZ	0.5	2	5	50*	30*
PA-12 L 2124	—	30	180	210	160
PA-12 P40 TL	—	—	105	—	—
PA-12 L 25W40	8	35	150	1000*	500*
PA-12 L 2140	—	12	71	—	130
PA-11 P 40 TL	—	—	55	130	—
PA-11 POTL	2	20	65	65	—
POM H 2320	5	10	130	35	40
POM 150 SA	2	4	20	—	—
PEE 4055	150	—	3000	—	1400
PEE 5556	120	—	1600	—	900
PEE 7246	—	—	—	—	300

* Calculated value. Diffusion constants based on normal room temperature. Actual behavior may vary considerably because of variations in processing the plastic.

Recommended tightening procedures

Connection	Thread sizes	Tightening torque	
		ft•lb	N•m
High Pressure			
1/4"	9/16" - 18	25	34
3/8"	3/4" - 16	50	69
9/16"	1-1/8" - 12	75	103
Medium Pressure			
1/4"	7/16" - 20	20	28
3/8"	9/16" - 18	30	41
9/16"	13/16" - 16	85	117
3/4"	3/4" NPSM	90	124
1"	1-3/8" - 12	125	173
Type "M" Swivel			
A9	9/16" - 18	25-30	34-41
A12	3/4" - 16	40-50	55-69
A14	7/8" - 14	50-60	69-83
A16	1" - 12	75-85	103-117
A21	1-5/16" - 12	100-120	138-166

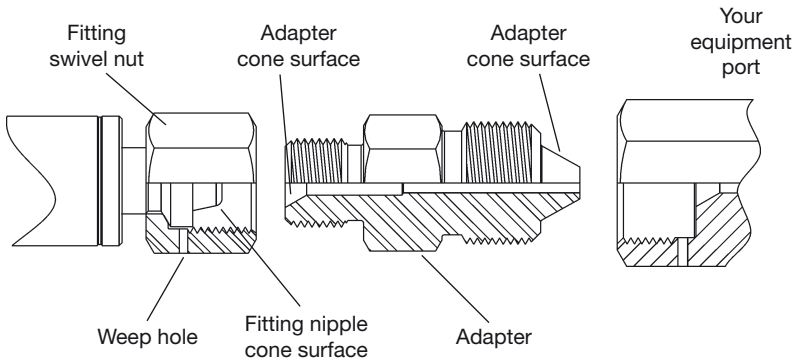

Leakage at swivel nut-to-adapter Joint (Seen by leak at weep hole in swivel nut)

1. Reduce system pressure to zero
2. Unscrew swivel nut and check cone surfaces of adapter and hose insert.
3. If hose insert is damaged, return hose to **polyflex** for repair and retest.
4. If cone surfaces look good after cleaning, re-tighten swivel nut. Do not exceed 150% of recommended torque.

Leakage at type "M" adapter-to-port (Seen by leak at weep hole in pressure port, or leak at threads for NPT adapters.)

1. Reduce system pressure to zero.
2. Slacken hose swivel nut.
3. Tighten adaptor into port.
4. Re-tighten swivel nut.

Never use the swivel nut to tighten the adapter into the port.

Metric conversion chart

	English to Metric			Metric to English		
	To Convert From	To	Multiply	To Convert From	To	Multiply
Area	sq. in. (in ²)	sq. mm (mm ²)	645.16	sq. mm (mm ²)	sq. in. (in ²)	0.00155
	sq. in. (in ²)	sq. cm (cm ²)	6.4516			
	sq. ft. (ft ²)	sq. meters (m ²)	0.0929			
Density	pounds/cubic foot (lb/ft ³)	Kilograms/cubic meter (kg/m ³)	16.02	Kilograms/cubic meter (kg/m ³)	pounds/cubic foot (lb/ft ³)	0.0624
Energy	British Thermal Units (Btu) (1 J = Ws = 0.2388 cal)	joules (J)	1055	joules (J)	British Thermal Units (Btu)	0.000947
Force	pounds - force (lbf) (1N = 0.102 kgf)	newtons (N)	4.448	newtons (N)	pounds - force (lbf)	0.2248
Length	inches (in)	millimeters (mm)	25.4	millimeters (mm)	inches (in)	0.03937
	feet (ft)	meters (m)	0.3048	meters (m)	feet (ft)	3.281
	miles (mi)	kilometers (km)	1.609	kilometers (km)	miles (mi)	0.621
Mass (Weight)	ounces (oz.)	grams (g)	28.35	grams (g)	ounces (oz.)	0.035
	pounds - mass (lb)	kilograms (kg)	0.4536	kilograms (kg)	pounds - mass (lb)	2.205
	short tons (2000 lb) (tn)	metric tons (1000 kg)	0.9072	metric tons (1000 kg)	short tons (2000 lb) (tn)	1.102
Power	horsepower (550 ft. lb/s) (hp)	kilowatts (kW)	0.7457	kilowatts (kW)	horsepower (550 ft. lb/s) (hp)	1.341
Pressure	pounds/square inch (psi)	kilograms (f)/square cm (kg(f)/cm ²)	0.0703	kilograms (f)/square cm (kg(f)/cm ²)	pounds/square inch (psi)	14.22
	pounds/square inch (psi)	kilopascals (kPa)	6.8948	kilopascals (kPa)	pounds/square inch (psi)	0.145
	pounds/square inch (psi)	bars (100 kPa)	0.06895	bars (100 kPa)	pounds/square inch (psi)	14.503
Stress	pounds/square inch (psi) (1N/mm ² = 1MPa)	megapascals (MPa)	0.006895	megapascals (MPa)	pounds/square inch (psi)	145.039
Temperature	degrees Fahrenheit (°F)	degrees Celsius (°C)	5/9 (after subtracting 32)	degrees Celsius (°C)	degrees Fahrenheit (°F)	9/5 (then add 32)
Torque or Bending Moment	pounds-force-foot (lb-ft)	Newtons-meter (Nm)	1.3567	Newtons-meter (Nm)	pounds-force-foot (lb-ft)	0.737
	pounds-force-inch (lb-in)	Newtons-meter (Nm)	0.113	Newtons-meter (Nm)	pounds-force-inch (lb-in)	8.85
Velocity	feet/seconds (ft/s)	meters/second (m/S)	0.3048	meters/second (m/S)	feet/seconds (ft/s)	3.2808
Viscosity	dynamic (centipoise)	Pascal-second (Pas)	0.001	Pascal-second (Pas)	dynamic (centipoise)	1000
	kenematic-foot ² /sec (ft ² /s)	meter ² /sec (m ² /s)	0.0929	meter ² /sec (m ² /s)	kenematic-foot ² /sec (ft ² /s)	10.7643
Volume	cubic inch (in ³)	cubic centimeter (cm ³) (milliliter)	16.3871	cubic centimeter (cm ³) (milliliter)	cubic inch (in ³)	0.061
	quarts (qt)	liters (1000 cm ³)	0.9464	liters (1000 cm ³)	quarts (qt)	1.057
	gallons (gal)	liters	3.7854	liters	gallons (gal)	0.2642

General chemical resistance table

Ratings code

- G – Good to excellent. Little or no swelling, tensile or surface changes. Preferred choice.
- L – Marginal or conditional. Noticeable effects but not necessarily indicating lack of serviceability. Further testing suggested for specific application. Very long-term effects such as stiffening or potential for crazing should be evaluated.
- P – Poor or unsatisfactory. Not recommended without extensive and realistic testing.
- – Indicates that this was not tested.

Materials code for hose core tubes

- N** Polyamide
- M** Coextruded tube with Fluoropolymer inner liner

Materials code for hose cover

- N** Polyamide
- U/HF** Polyurethane

Notes on the chemical resistance table

- (1) The fluid resistance tables are simplified rating tabulations based on immersion tests at 24° C. Higher temperatures tend to reduce ratings. Since final selection depends on pressure, fluid and ambient temperature and other factors not known to Parker Hannifin, no performance guarantee is expressed or implied. The indications do not imply any compliance with standards and regulations and do not refer to possible changes of colour, taste or smell. For food and drinking water specially approved materials have to be used. For fluids not listed or for advice on particular applications, please consult Parker Hannifin GmbH, **polyflex** Division in Hüttenfeld, Germany.
- (2) Hose applications for these fluids must take into account legal and insurance regulations. The chemical resistance indicated does not express or imply approval by certain institutions.
- (3) Satisfactory at some concentrations and temperatures, unsatisfactory at others.
- (4) For gas applications, the cover should be pin-pricked and the pressure must not be released quickly. Special safety guard accessories are to be used to prevent damage or personal injury in the event of failure..
- (5) Chemical resistance does not imply low permeation rates. Please consult Parker Hannifin for a recommendation for your specific requirements.
- (6) The indication of chemical resistance does not imply any special food compatibility; it refers only to the chemical resistance of the material.
- (7) Chemical resistance does not imply acceptability for use in airless paintspray applications. These applications require a special, electrically conductive hose.

Not all remarks may apply to Oil&Gas products

General chemical resistance table

Chemical	N	U/HF	M
Acetone	G	P	L
Acetylene	--	--	--
Air (4)	G	G	G
Ammonium Chloride	P	G	G
Ammonium Hydroxyde	G	P	G
Anhydrous Ammonia	P	P	--
Aniline	P	P	G
Aromatic Hydrocarbons	G	L	--
Asphalt	G	G	L
Benzene	G	L	G
Butane (2) (4)	G	L	--
Calcium Chloride	--	G	G
Carbon Dioxide (4)	G	G	--
Carbon Monoxide (4)	--	G	--
Carbon Tetrachloride	G	P	G
Chlorinated Hydrocarbon Base Fluids	G	L	--
Chlorinated Petroleum Oil	G	L	--
Chlorinated Solvents	--	P	--
Chlorine, Gaseous, Dry	P	P	--
Chromic Acid	--	P	L
Citric Acid Solutions	G	L	G
Crude Petroleum Oil	G	G	--
Cyclohexan (2)	G	G	G
Diesel Fuel (2)	G	G	--
Diester Oils	G	P	--
Ethanol (6)	G	L	--
Ethers	G	P	G
Ethylene Glycol	G	L	G
Ethylene Oxide	G	L	--
Fatty Acids	G	--	G
Formaldehyde	L	P	G
Formic Acid J	P	P	G
Fuel Oil (2)	G	L	G
Gas (Oil) (2)	G	G	
Gasoline	G	--	G
Glycerine	G	L	G
Glycols (to 1350 °F)	G	L	G

Technical Info

Chemical	N	U/HF	M
Grease (petroleum base)	G	G	--
Hexane (2)	G	G	G
Hydraulic Fluid (petroleum base)	G	G	L
Hydraulic Fluid phosphate ester base)	G	L	--
Hydraulic Fluid water base)	G	G	--
Hydraulic oil (petroleum base)	G	G	L
Hydrochloric Acid	L	P	G
Hydrofluoric Acid	P	P	G
Hydrolube (hydraulic fluid/water glycol base)	G	L	--
IRUS 902 (hydraulic fluid/water-oil emulsion)	G	G	--
Isooctane (2)	G	G	G
Kerosene (2)	G	L	G
Ketones	G	P	G
Lime (calcium oxide)	G	G	G
Lindol (hydraulic fluid/phosphate esters)	G	P	--
LP-Gas	--	--	--
Lubricating Oils (diester base)	G	P	--
Lubricating Oils (petroleum base)	G	G	G
Methane	--	--	--
Methanol	G	P	--
Methyl Alcohol (6)	G	P	G
Methyl Ethyl Ketone (MEK)	G	P	G
Methyl Ethyl Ketone Peroxide (MEKP)	L	P	--
Methyl Osobuthyl Ketone (MIBK)	G	P	G
Methylen Chloride	L	P	G
Mineral Oil	G	G	G
Mineral Spirits	--	L	--
Motor Oils	G	G	G
Naphta	G	P	G
Natural Gas (4)	--	--	--
Nitric Acid	P	P	L
Nitrobenzene	G	P	G
Nitrogen, Gaseous (4) (5)	G	G	G
Nitrous Oxide	L	--	--
Oil (SAE)	G	G	--
Oxygen, Gaseous (4) (5) (6)	G	G	G
Ozone	P	L	G

General chemical resistance table

Chemical	N	U/HF	M
Pentane (2)	G	L	G
Perchloric Acid	P	P	L
Petroleum Ether	--	--	--
Petroleum Oils	G	G	--
Phenols	P	P	--
Phosphate Esters (above 135 °F)	G	P	--
Phosphate Esters (to 135 °F)	G	P	--
Propane (4) (5)	--	--	--
Propylen Glycol	--	G	G
Salt Water	--	--	G
Silicone Greases	G	G	--
Silicone Oils	G	G	--
Sodium Borate	G	G	G
Sodium Carbonate	--	--	--
Sodium Chloride Solutions	G	G	G
Sodium Hydroxide, 50%	P	P	G
Sodium Hypochloride	P	P	G
Steam	P	P	G
Straight Synthetic Oils (phosphate esters)	G	P	--
Sulphur Dioxide	L	L	G
Sulphur Hexafluoride Gas (4) (5)	G	G	--
Sulphuric Acid	P	P	--
Toluol, Toluene	G	L	G
Trichlorethylene	L	P	G
Ucon (hydraulic fluid/water glycol base)	G	L	--
Water (above 60 °C) (6)	G	P	L
Water (to 60 °C) (6)	G	G	G
Water Glycols (above 60 °C)	L	P	--
Water Glycols (to 60 °C)	G	L	--
Water in oil Emulsions (above 60 °C)	L	P	--
Water in oil Emulsions (to 60 °C)	G	L	--
Xylene	G	P	G
Zinc Chloride	G	G	G

Technical Info



Parker safety guide

for selecting and using hose, tubing, fittings, and related accessories

Parker Publication No. 4400-B.1
Revised: May 2002

WARNING: Failure or improper selection or improper use of hose, tubing, fittings, assemblies or related accessories ("Products") can cause death, personal injury and property damage. Possible consequences of failure or improper selection or improper use of these Products include but are not limited to:

- Fittings thrown off at high speed.
- High velocity fluid discharge.
- Explosion or burning of the conveyed fluid.
- Electrocutation from high voltage electric power lines.
- Contact with suddenly moving or falling objects that are controlled by the conveyed fluid.
- Injections by high-pressure fluid discharge.
- Dangerously whipping Hose.
- Contact with conveyed fluids that may be hot, cold, toxic or otherwise injurious.
- Sparking or explosion caused by static electricity buildup or other sources of electricity.
- Sparking or explosion while spraying paint or flammable liquids.
- Injuries resulting from inhalation, ingestion or exposure to fluids.

Before selecting or using any of these Products, it is important that you read and follow the instructions below. Only Hose from Parker's Stratoflex Products Division is approved for in flight aerospace applications, and no other Hose can be used for such in flight applications.

1.0 GENERAL INSTRUCTIONS

- 1.1 Scope: This safety guide provides instructions for selecting and using (including assembling, installing, and maintaining) these Products. For convenience, all rubber and/or thermoplastic products commonly called "hose" or "tubing" are called "Hose" in this safety guide. All assemblies made with Hose are called "Hose Assemblies". All products commonly called "fittings" or "couplings" are called "Fittings". All related accessories (including crimping and swaging machines and tooling) are called "Related Accessories". This safety guide is a supplement to and is to be used with, the specific Parker publications for the specific Hose, Fittings and Related Accessories that are being considered for use.
- 1.2 Fail-Safe: Hose, and Hose Assemblies and Fittings can and do fail without warning for many reasons. Design all systems and equipment in a fail-safe mode, so that failure of the Hose or Hose Assembly or Fitting will not endanger persons or property.
- 1.3 Distribution: Provide a copy of this safety guide to each person that is responsible for selecting or using Hose and Fitting products. Do not select or use Parker Hose or Fittings without thoroughly reading and understanding this safety guide as well as the specific Parker publications for the products considered or selected.
- 1.4 User Responsibility: Due to the wide variety of operating conditions and applications for Hose and Fittings, Parker and its distributors do not represent or warrant that any particular Hose or Fitting is suitable for any specific end use system. This safety guide does not analyze all technical parameters that must be considered in selecting a product. The user, through its own analysis and testing, is solely responsible for:
- Making the final selection of the Hose and Fitting.
 - Assuring that the user's requirements are met and that the application presents no health or safety hazards.
 - Providing all appropriate health and safety warnings on the equipment on which the Hose and Fittings are used.
 - Assuring compliance with all applicable government and industry standards.

1.5 Additional Questions: Call the appropriate Parker technical service department if you have any questions or require any additional information. See the Parker publication for the product being considered or used, or call 1-800-CPARKER, or go to www.parker.com, for telephone numbers of the appropriate technical service department.

2.0 HOSE AND FITTING SELECTION INSTRUCTIONS

2.1 Electrical Conductivity: Certain applications require that the Hose be nonconductive to prevent electrical current flow. Other applications require the Hose and the Fitting and the Hose/Fitting interface to be sufficiently conductive to drain off static electricity. Extreme care must be exercised when selecting Hose and Fittings for these or any other applications in which electrical conductivity or nonconductivity is a factor.

The electrical conductivity or nonconductivity of Hose and Fittings is dependent upon many factors and may be susceptible to change. These factors include but are not limited to the various materials used to make the Hose and the Fittings, Fitting finish (some Fitting finishes are electrically conductive while others are nonconductive), manufacturing methods (including moisture control), how the Fittings contact the Hose, age and amount of deterioration or damage or other changes, moisture content of the Hose at any particular time, and other factors.

The following are considerations for electrically nonconductive and conductive Hose. For other applications consult the individual catalog pages and the appropriate industry or regulatory standards for proper selection.

2.1.1 Electrically Nonconductive Hose: Certain applications require that the Hose be nonconductive to prevent electrical current flow or to maintain electrical isolation. For these applications that require Hose to be electrically nonconductive, including but not limited to applications near high voltage electric lines, only special nonconductive Hose can be used. The manufacturer of the equipment in which the nonconductive Hose is to be used must be consulted to be

certain that the Hose and Fittings that are selected are proper for the application. Do not use any Parker Hose or Fitting for any such application requiring nonconductive Hose, including but not limited to applications near high voltage electric lines, unless (i) the application is expressly approved in the Parker technical publication for the product, (ii) the Hose is marked “nonconductive”, and (iii) the manufacturer of the equipment on which the Hose is to be used specifically approves the particular Parker Hose and Fitting for such use.

2.1.2 Electrically Conductive Hose: Parker manufactures special Hose for certain applications that require electrically conductive Hose. Parker manufactures special Hose for conveying paint in airless paint spraying applications. This Hose is labeled “Electrically Conductive Airless Paint Spray Hose” on its layline and packaging. This Hose must be properly connected to the appropriate Parker Fittings and properly grounded in order to dissipate dangerous static charge buildup, which occurs in all airless paint spraying applications. Do not use any other Hose for airless paint spraying, even if electrically conductive. Use of any other Hose or failure to properly connect the Hose can cause a fire or an explosion resulting in death, personal injury, and property damage. Parker manufactures a special Hose for certain compressed natural gas (“CNG”) applications where static electricity buildup may occur. Parker CNG Hose assemblies comply with AGA Requirements 1-93, “Hoses for Natural Gas Vehicles and Fuel Dispensers”. This Hose is labeled “Electrically Conductive for CNG Use” on its layline and packaging. This Hose must be properly connected to the appropriate Parker Fittings and properly grounded in order to dissipate dangerous static charge buildup, which occurs in, for example, high velocity CNG dispensing or transfer. Do not use any other Hose for CNG applications where static charge buildup may occur, even if electrically conductive. Use of other Hoses in CNG applications or failure to properly connect or ground this Hose can cause a fire or an explosion resulting in death, personal injury, and property damage. Care must also be taken to protect

against CNG permeation through the Hose wall. See section 2.6, Permeation, for more information. Parker CNG Hose is intended for dispenser and vehicle use at a maximum temperature of 180°F. Parker CNG Hose should not be used in confined spaces or unventilated areas or areas exceeding 180°F. Final assemblies must be tested for leaks. CNG Hose Assemblies should be tested on a monthly basis for conductivity per AGA 1-93.

Parker manufactures special Hose for aerospace in-flight applications. Aerospace in-flight applications employing Hose to transmit fuel, lubricating fluids and hydraulic fluids require a special Hose with a conductive inner tube. This Hose for in-flight applications is available only from Parker's Stratoflex Products Division. Do not use any other Parker Hose for in-flight applications, even if electrically conductive. Use of other Hoses for in-flight applications or failure to properly connect or ground this Hose can cause a fire or an explosion resulting in death, personal injury, and property damage. These Hose assemblies for in-flight applications must meet all applicable aerospace industry, aircraft engine, and aircraft requirements.

- 2.2 Pressure: Hose selection must be made so that the published maximum recommended working pressure of the Hose is equal to or greater than the maximum system pressure. Surge pressures or peak transient pressures in the system must be below the published maximum working pressure for the Hose. Surge pressures and peak pressures can usually only be determined by sensitive electrical instrumentation that measures and indicates pressures at millisecond intervals. Mechanical pressure gauges indicate only average pressures and cannot be used to determine surge pressures or peak transient pressures. Published burst pressure ratings for Hose is for manufacturing test purposes only and is no indication that the Product can be used in applications at the burst pressure or otherwise above the published maximum recommended working pressure.
- 2.3 Suction: Hoses used for suction applications must be selected to insure that the

Hose will withstand the vacuum and pressure of the system. Improperly selected Hose may collapse in suction application.

- 2.4 Temperature: Be certain that fluid and ambient temperatures, both steady and transient, do not exceed the limitations of the Hose. Temperatures below and above the recommended limit can degrade Hose to a point where a failure may occur and release fluid. Properly insulate and protect the Hose Assembly when routing near hot objects (e.g. manifolds). Do not use any Hose in any application where failure of the Hose could result in the conveyed fluids (or vapors or mist from the conveyed fluids) contacting any open flame, molten metal, or other potential fire ignition source that could cause burning or explosion of the conveyed fluids or vapors.
- 2.5 Fluid Compatibility: Hose Assembly selection must assure compatibility of the Hose tube, cover, reinforcement, and Fittings with the fluid media used. See the fluid compatibility chart in the Parker publication for the product being considered or used. This information is offered only as a guide. Actual service life can only be determined by the end user by testing under all extreme conditions and other analysis. Hose that is chemically compatible with a particular fluid must be assembled using Fittings and adapters containing likewise compatible seals.
- 2.6 Permeation: Permeation (that is, seepage through the Hose) will occur from inside the Hose to outside when Hose is used with gases, liquid and gas fuels, and refrigerants (including but not limited to such materials as helium, diesel fuel, gasoline, natural gas, or LPG). This permeation may result in high concentrations of vapors which are potentially flammable, explosive, or toxic, and in loss of fluid. Dangerous explosions, fires, and other hazards can result when using the wrong Hose for such applications. The system designer must take into account the fact that this permeation will take place and must not use Hose if this permeation could be hazardous. The system designer must take into account all legal, government,

insurance, or any other special regulations which govern the use of fuels and refrigerants. Never use a Hose even though the fluid compatibility is acceptable without considering the potential hazardous effects that can result from permeation through the Hose Assembly.

Permeation of moisture from outside the Hose to inside the Hose will also occur in Hose assemblies, regardless of internal pressure. If this moisture permeation would have detrimental effects (particularly, but not limited to refrigeration and air conditioning systems), incorporation of sufficient drying capacity in the system or other appropriate system safeguards should be selected and used.

- 2.7 **Size:** Transmission of power by means of pressurized fluid varies with pressure and rate of flow. The size of the components must be adequate to keep pressure losses to a minimum and avoid damage due to heat generation or excessive fluid velocity.
- 2.8 **Routing:** Attention must be given to optimum routing to minimize inherent problems (kinking or flow restriction due to Hose collapse, twisting of the Hose, proximity to hot objects or heat sources).
- 2.9 **Environment:** Care must be taken to insure that the Hose and Fittings are either compatible with or protected from the environment (that is, surrounding conditions) to which they are exposed. Environmental conditions including but not limited to ultraviolet radiation, sunlight, heat, ozone, moisture, water, salt water, chemicals, and air pollutants can cause degradation and premature failure.
- 2.10 **Mechanical Loads:** External forces can significantly reduce Hose life or cause failure. Mechanical loads which must be considered include excessive flexing, twist, kinking, tensile or side loads, bend radius, and vibration. Use of swivel type Fittings or adapters may be required to insure no twist is put into the Hose. Unusual applications may require special testing prior to Hose selection.
- 2.11 **Physical Damage:** Care must be taken to protect Hose from wear, snagging, kinking, bending smaller than minimum bend radius, and cutting, any of which can cause premature Hose failure. Any Hose that has been kinked or bent to a radius smaller than the minimum bend radius, and any Hose that has been cut or is cracked or is otherwise damaged, should be removed and discarded.
- 2.12 **Proper End Fitting:** See instructions 3.2 through 3.5. These recommendations may be substantiated by testing to industry standards such as SAE J517 for hydraulic applications, or MIL-A-5070, AS1339, or AS3517 for Hoses from Parker's Stratoflex Products Division for aerospace applications.
- 2.13 **Length:** When establishing a proper Hose length, motion absorption, Hose length changes due to pressure, and Hose and machine tolerances and movement must be considered.
- 2.14 **Specifications and Standards:** When selecting Hose and Fittings, government, industry, and Parker specifications and recommendations must be reviewed and followed as applicable.
- 2.15 **Hose Cleanliness:** Hose components may vary in cleanliness levels. Care must be taken to insure that the Hose Assembly selected has an adequate level of cleanliness for the application.
- 2.16 **Fire Resistant Fluids:** Some fire resistant fluids that are to be conveyed by Hose require use of the same type of Hose as used with petroleum base fluids. Some such fluids require a special Hose, while a few fluids will not work with any Hose at all. See instructions 2.5 and 1.5. The wrong Hose may fail after a very short service. In addition, all liquids but pure water may burn fiercely under certain conditions, and even pure water leakage may be hazardous.
- 2.17 **Radiant Heat:** Hose can be heated to destruction without contact by such nearby items as hot manifolds or molten metal. The same heat source may then initiate a fire. This can occur despite the presence of cool air around the Hose.

- 2.18 **Welding or Brazing:** When using a torch or arc welder in close proximity to hydraulic lines, the hydraulic lines should be removed or shielded with appropriate fire resistant materials. Flame or weld spatter could burn through the Hose and possibly ignite escaping fluid resulting in a catastrophic failure. Heating of plated parts, including Hose Fittings and adapters, above 450°F (232°C) such as during welding, brazing, or soldering may emit deadly gases.
- 2.19 **Atomic Radiation:** Atomic radiation affects all materials used in Hose assemblies. Since the long-term effects may be unknown, do not expose Hose assemblies to atomic radiation.
- 2.20 **Aerospace Applications:** The only Hose and Fittings that may be used for in-flight aerospace applications are those available from Parker's Stratoflex Products Division. Do not use any other Hose or Fittings for in-flight applications. Do not use any Hose or Fittings from Parker's Stratoflex Products Division with any other Hose or Fittings, unless expressly approved in writing by the engineering manager or chief engineer of Stratoflex Products Division and verified by the user's own testing and inspection to aerospace industry standards.
- 2.21 **Unlocking Couplings:** Ball locking couplings or other couplings with disconnect sleeves can unintentionally disconnect if they are dragged over obstructions or if the sleeve is bumped or moved enough to cause disconnect. Threaded couplings should be considered where there is a potential for accidental uncoupling.
- 3.0 HOSE AND FITTING ASSEMBLY AND INSTALLATION INSTRUCTIONS**
- 3.1 **Component Inspection:** Prior to assembly, a careful examination of the Hose and Fittings must be performed. All components must be checked for correct style, size, catalog number, and length. The Hose must be examined for cleanliness, obstructions, blisters, cover looseness, kinks, cracks, cuts or any other visible defects. Inspect the Fitting and sealing surfaces for burrs, nicks, corrosion or other imperfections. Do NOT use any component that displays any signs of nonconformance.
- 3.2 **Hose and Fitting Assembly:** Do not assemble a Parker Fitting on a Parker Hose that is not specifically listed by Parker for that Fitting, unless authorized in writing by the engineering manager or chief engineer of the appropriate Parker division. Do not assemble a Parker Fitting on another manufacturer's Hose or a Parker Hose on another manufacturer's Fitting unless (i) the engineering manager or chief engineer of the appropriate Parker division approves the Assembly in writing or that combination is expressly approved in the appropriate Parker literature for the specific Parker product, and (ii) the user verifies the Assembly and the application through analysis and testing. For Parker Hose that does not specify a Parker Fitting, the user is solely responsible for the selection of the proper Fitting and Hose Assembly procedures. See instruction 1.4. The Parker published instructions must be followed for assembling the Fittings on the Hose. These instructions are provided in the Parker Fitting catalog for the specific Parker Fitting being used, or by calling 1-800-CPARKER, or at www.parker.com.
- 3.3 **Related Accessories:** Do not crimp or swage any Parker Hose or Fitting with anything but the listed swage or crimp machine and dies in accordance with Parker published instructions. Do not crimp or swage another manufacturer's Fitting with a Parker crimp or swage die unless authorized in writing by the engineering manager or chief engineer of the appropriate Parker division.
- 3.4 **Parts:** Do not use any Parker Fitting part (including but not limited to socket, shell, nipple, or insert) except with the correct Parker mating parts, in accordance with Parker published instructions, unless authorized in writing by the engineering manager or chief engineer of the appropriate Parker division.
- 3.5 **Reusable/Permanent:** Do not reuse any field attachable (reusable) Hose Fitting that has blown or pulled off a Hose. Do not reuse a Parker permanent Hose Fitting (crimped or

swaged) or any part thereof. Complete Hose Assemblies may only be reused after proper inspection under section 4.0. Do not assemble Fittings to any previously used hydraulic Hose that was in service, for use in a fluid power application.

- 3.6 Pre-Installation Inspection: Prior to installation, a careful examination of the Hose Assembly must be performed. Inspect the Hose Assembly for any damage or defects. Do NOT use any Hose Assembly that displays any signs of nonconformance.
- 3.7 Minimum Bend Radius: Installation of a Hose at less than the minimum listed bend radius may significantly reduce the Hose life. Particular attention must be given to preclude sharp bending at the Hose to Fitting juncture. Any bending during installation at less than the minimum bend radius must be avoided. If any Hose is kinked during installation, the Hose must be discarded.
- 3.8 Twist Angle and Orientation: Hose Assembly installation must be such that relative motion of machine components does not produce twisting.
- 3.9 Securement: In many applications, it may be necessary to restrain, protect, or guide the Hose to protect it from damage by unnecessary flexing, pressure surges, and contact with other mechanical components. Care must be taken to insure such restraints do not introduce additional stress or wear points.
- 3.10 Proper Connection of Ports: Proper physical installation of the Hose Assembly requires a correctly installed port connection insuring that no twist or torque is transferred to the Hose when the Fittings are being tightened or otherwise during use.
- 3.11 External Damage: Proper installation is not complete without insuring that tensile loads, side loads, kinking, flattening, potential abrasion, thread damage, or damage to sealing surfaces are corrected or eliminated. See instruction 2.10.
- 3.12 System Checkout: All air entrapment must be eliminated and the system pressurized to

the maximum system pressure (at or below the Hose maximum working pressure) and checked for proper function and freedom from leaks. Personnel must stay out of potential hazardous areas while testing and using.

- 3.13 Routing: The Hose Assembly should be routed in such a manner so if a failure does occur, the escaping media will not cause personal injury or property damage. In addition, if fluid media comes in contact with hot surfaces, open flame, or sparks, a fire or explosion may occur. See section 2.4.

4.0 HOSE AND FITTING MAINTENANCE AND REPLACEMENT INSTRUCTIONS

- 4.1 Even with proper selection and installation, Hose life may be significantly reduced without a continuing maintenance program. The severity of the application, risk potential from a possible Hose failure, and experience with any Hose failures in the application or in similar applications should determine the frequency of the inspection and the replacement for the Products so that Products are replaced before any failure occurs. A maintenance program must be established and followed by the user and, at minimum, must include instructions 4.2 through 4.7.
- 4.2 Visual Inspection Hose/Fitting: Any of the following conditions require immediate shut down and replacement of the Hose Assembly:
- Fitting slippage on Hose;
 - Damaged, cracked, cut or abraded cover (any reinforcement exposed);
 - Hard, stiff, heat cracked, or charred Hose;
 - Cracked, damaged, or badly corroded Fittings;
 - Leaks at Fitting or in Hose;
 - Kinked, crushed, flattened or twisted Hose; and
 - Blistered, soft, degraded, or loose cover.
- 4.3 Visual Inspection All Other: The following items must be tightened, repaired, corrected or replaced as required:
- Leaking port conditions;
 - Excess dirt buildup;
 - Worn clamps, guards or shields; and
 - System fluid level, fluid type, and any air entrapment.

- 4.4 **Functional Test:** Operate the system at maximum operating pressure and check for possible malfunctions and leaks. Personnel must avoid potential hazardous areas while testing and using the system. See section 2.2.
- 4.5 **Replacement Intervals:** Hose assemblies and elastomeric seals used on Hose Fittings and adapters will eventually age, harden, wear and deteriorate under thermal cycling and compression set. Hose Assemblies and elastomeric seals should be inspected and replaced at specific replacement intervals, based on previous service life, government or industry recommendations, or when failures could result in unacceptable downtime, damage, or injury risk. See section 1.2.
- 4.6 **Hose Inspection and Failure:** Hydraulic power is accomplished by utilizing high-pressure fluids to transfer energy and do work. Hoses, Fittings, and Hose Assemblies all contribute to this by transmitting fluids at high pressures. Fluids under pressure can be dangerous and potentially lethal and, therefore, extreme caution must be exercised when working with fluids under pressure and handling the Hoses transporting the fluids. From time to time, Hose Assemblies will fail if they are not replaced at proper time intervals. Usually these failures are the result of some form of misapplication, abuse, wear, or failure to perform proper maintenance. When Hoses fail, generally the high-pressure fluids inside escape in a stream which may or may not be visible to the user. Under no circumstances should the user attempt to locate the leak by “feeling” with their hands or any other part of their body. High-pressure fluids can and will penetrate the skin and cause severe tissue damage and possibly loss of limb. Even seemingly minor hydraulic fluid injection injuries must be treated immediately by a physician with knowledge of the tissue damaging properties of hydraulic fluid. If a Hose failure occurs, immediately shut down the equipment and leave the area until pressure has been completely released from the Hose Assembly. Simply shutting down the hydraulic pump may or may not eliminate the pressure in the Hose Assembly. Many times check valves, etc., are employed in a system and can cause pressure to remain in a Hose Assembly even when pumps or equipment are not operating. Tiny holes in the Hose, commonly known as pinholes, can eject small, dangerously powerful but hard to see streams of hydraulic fluid. It may take several minutes or even hours for the pressure to be relieved so that the Hose Assembly may be examined safely. Once the pressure has been reduced to zero, the Hose Assembly may be taken off the equipment and examined. It must always be replaced if a failure has occurred. Never attempt to patch or repair a Hose Assembly that has failed. Consult the nearest Parker distributor or the appropriate Parker division for Hose Assembly replacement information. Never touch or examine a failed Hose Assembly unless it is obvious that the Hose no longer contains fluid under pressure. The high-pressure fluid is extremely dangerous and can cause serious and potentially fatal injury.
- 4.7 **Elastomeric seals:** Elastomeric seals will eventually age, harden, wear and deteriorate under thermal cycling and compression set. Elastomeric seals should be inspected and replaced.
- 4.8 **Refrigerant gases:** Special care should be taken when working with refrigeration systems. Sudden escape of refrigerant gases can cause blindness if the escaping gases contact the eye and can cause freezing or other severe injuries if it contacts any other portion of the body.
- 4.9 **Compressed natural gas (CNG):** Parker CNG Hose Assemblies should be tested after installation and before use, and at least on a monthly basis per AGA 1-93 Section 4.2 “Visual Inspection Hose/Fitting”. The recommended procedure is to pressurize the Hose and check for leaks and to visually inspect the Hose for damage. Caution: Matches, candles, open flame or other sources of ignition shall not be used for Hose inspection. Leak check solutions should be rinsed off after use.

Chapter K**Index of part numbers**

Index K-2

Index of part numbers

Part number	page	Part number	page
1018X-2-025	D-13, D-35	106TX-4-025W	C-4
1018X-4-025	D-13, D-35	106TX-4-02W	C-4
1018X-4-04	D-28, D-35, D-46	106TX-6-03W	C-4
1018X-4-04ZE	D-35	106TX-6-04W	C-4
1018X-6-04ZE	D-35	1078X-4-04	D-30, D-37, D-49
1018X-6-05	D-35	1078X-4-04C2W	D-30, D-49
1018X-6-06	D-13, D-35	1078X-6-05	D-37
1018X-6-4	D-28, D-35, D-46	1078X-6-05C2W	D-37
1018X-8-06	D-13, D-35	1078X-6-06	D-15, D-37
1018X-8-08	D-13	1078X-6-06C2W	D-15, D-37
101BL-12-12	D-54	1078X-8-08	D-15
101BL-6-06	D-54	1078X-8-08C2W	D-15
101BL-6-06ZE	D-54	10C8X-12-06	D-10
101BL-8-08	D-54	10C8X-14-06	D-10
101BL-8-08C	D-54	10C8X-16-08	D-10
101BL-8-08ZE	D-54	1158X-8-08	D-16
101BS-4-04	D-41	115NX-20-20	D-16
101BS-8-08	D-41	1178X-8-08	D-17
101BS-8-08C	D-41	117NX-20-20	D-17
101TX-1-025W	C-6	1198X-8-08	D-17
101TX-1-02W	C-6	119NX-20-20	D-17
101TX-2-025W	C-6	11C8X-14-06	D-10
101TX-2-02W	C-6	11C8X-16-08	D-10
101TX-2-03W	C-6	13B8X-4-025	D-13, D-38
101TX-4-025W	C-6	13B8X-4-04	D-27, D-38, D-50
101TX-4-03W	C-6	13B8X-6-04	D-27, D-38, D-50
101TX-4-04W	C-6	13B8X-6-05	D-38
101TX-4-05W	C-6	13B8X-6-06	D-13, D-38
101TX-6-05W	C-6	13B8X-8-06	D-13, D-38
1038X-10-08	D-14	13B8X-8-08	D-13
1038X-8-06	D-14	13BNX-24-20	D-13, D-38
103NX-24-20	D-14	16A8X-8-08	D-18
1058X-4-04	D-28, D-49	16ANX-20-20	D-18
1058X-6-04	D-28, D-49	16F8X-8-08	D-18
1063X-6-06C	D-21	16FNX-20-20	D-18
10655-4-4C	D-21	16N8X-8-08	D-19
10655-6-6C	D-21	16NNX-20-20	D-19
10655-8-8C	D-21	16Y2X-4-025	E-18, E-27
1068X-10-08	D-14	16Y2X-4-03	E-18, E-27
1068X-4-4	D-29, D-36, D-46	1923X-8-06C	D-22
1068X-5-04	D-29, D-36, D-46	19255-4-4C	D-22
1068X-6-04C	D-21	19255-6-6C	D-22
1068X-6-05	D-36	19255-8-8C	D-22
1068X-6-06	D-14	1925X-4-1 3	E-21
1068X-6-4	D-29, D-36, D-46	1928X-4-025	D-11, D-36
1068X-8-05	D-36	1928X-4-04	D-25, D-36, D-47, D-51
1068X-8-06	D-14	1928X-6-04C	D-22
1068X-8-08	D-14	1928X-6-06	D-11, D-36
106LX-8-08C	D-21	1928X-8-06	D-11, D-36
106NX-20-20	D-14	1928X-8-08	D-11

Part number	page	Part number	page
192BL-16-12	D-55	1AYLX-6-02	E-7
192BL-6-06	D-55	1AYLX-6-03	E-7
192BL-8-08	D-55	1AYLX-6-03C	E-7
192BL-8-08C	D-55	1AYLX-6-04	E-7
192BS-4-04	D-42	1AYLX-8-05	E-7
192BS-8-08	D-42	1AYLX-8-05C	E-7
192BS-8-08C	D-42	1AYLX-8-06	E-7
192EH-12-12	B-3, B-7	1AYLX-8-06C	E-7
192EH-16-16	B-3, B-7	1AYTX-6-025W	C-4
192EH-20-20	B-3, B-7	1AYTX-6-02W	C-4
192EH-8-08	B-3, B-7	1AYTX-6-03W	C-4
192KX-4-04W	D-33	1AYTX-6-04W	C-4
192KX-6-05W	D-33	1AYTX-8-05W	C-4
192KX-6-06W	D-6	1C35X-8-03	E-20
192KX-8-08W	D-6	1C38X-10-06	D-8
192LX-16-12	E-9	1C38X-10-06C2W	D-8
192LX-20-16	E-9	1C38X-12-06	D-8
192LX-4-03	E-9	1C38X-12-06C2W	D-8
192LX-6-05	E-9	1C38X-12-08	D-8
192LX-8-06	E-9	1C38X-12-08C2W	D-8
192LX-8-08	D-36, E-9	1C38X-15-08	D-8
1AY2X-10-05	E-16, E-27, E-31, E-34, F-4, F-7, F-10	1C38X-15-08C2W	D-8
1AY2X-13-05	E-16, E-27, E-31, E-34, F-4, F-7, F-10	1C38X-8-04	D-48
1AY2X-6-025	E-16, E-27	1C3LX-8-03	E-10
1AY2X-6-03	E-16, E-27, F-4	1C3LX-8-04	E-10
1AY2X-8-05	E-16, E-27, E-31, E-34, F-4, F-7, F-10	1C68X-14-06	D-9
1AY5X-11-08	E-19	1C68X-16-08	D-9
1AY5X-16-12	E-19	1C6LX-12-05	E-10
1AY5X-6-03	E-19	1C93X-14-06C	D-23
1AY5X-8-05	E-19	1C93X-16-06C	D-23
1AY8X-6-025	D-16	1C955-10-4C	D-23
1AY8X-6-04	D-29, D-40, D-45	1C955-12-4C	D-23
1AY8X-8-05	D-34	1C955-12-6C	D-23
1AY8X-8-06	D-34	1C955-16-8C	D-23
1AYBL-11-06	D-57	1C955-8-4C	D-23
1AYBL-11-08	D-57	1C95X-12-05	E-19
1AYBL-11-08C	D-57	1C95X-16-08	E-19
1AYBS-11-08	D-45	1C95X-25-12	E-19
1AYCX-11-08W	E-24	1C98X-10-04	D-25, D-39, D-51
1AYCX-16-16W	E-24	1C98X-10-04C	D-23
1AYJX-11-08W	E-16	1C98X-12-06	D-9, D-39
1AYJX-16-12W	E-16, E-24	1C98X-14-06	D-9, D-39
1AYKX-11-08W	D-7	1C98X-16-08	D-9
1AYKX-6-04W	D-34	1C98X-8-025	D-9, D-39
1AYKX-8-05W	D-34	1C98X-8-04	D-25, D-39, D-51
1AYKX-8-06W	D-7	1C98X-8-04C	D-23
1AYLX-11-08	E-7	1C9BL-14-06	D-56
1AYLX-11-08C	E-7	1C9BL-14-08	D-56
1AYLX-16-12	E-7	1C9BL-14-08C	D-56
1AYLX-16-12C	E-7	1C9BL-16-06	D-56

Part number	page	Part number	page
1C9BL-16-08.....	D-56	1U08X-4-04C2W.....	D-26, D-50
1C9BL-16-08C.....	D-56	1U08X-6-04.....	D-26, D-38, D-50
1C9BL-25-12.....	D-56	1U08X-6-04C2W.....	D-26, D-50
1C9BS-10-04.....	D-44	1U08X-6-05.....	D-38
1C9BS-14-08.....	D-44	1U08X-6-05C2W.....	D-38
1C9BS-14-08C.....	D-44	1U08X-6-06.....	D-12, D-38
1C9BS-16-04.....	D-44	1U08X-6-06C2W.....	D-12, D-38
1C9BS-16-08.....	D-44	1U08X-8-06.....	D-12, D-38
1C9BS-16-08C.....	D-44	1U08X-8-06C2W.....	D-12, D-38
1C9CX-16-08W.....	E-23	1U08X-8-08.....	D-12
1C9CX-30-16W.....	E-23	1U08X-8-08C2W.....	D-12
1C9JX-16-08W.....	E-16	1U0TX-2-02W.....	C-5
1C9JX-25-12W.....	E-16, E-23	1U0TX-4-025W.....	C-5
1C9JX-30-16W.....	E-16	1U0TX-4-02W.....	C-5
1C9KX-10-04W.....	D-33	1U0TX-4-03W.....	C-5
1C9KX-14-06W.....	D-6	1U0TX-4-04W.....	C-5
1C9KX-16-05W.....	D-33	1U0TX-6-05W.....	C-5
1C9KX-16-08W.....	D-6	1Y2CX-16-16W.....	E-24
1C9LX-14-06.....	E-6	1Y42X-4-025.....	E-17, E-26
1C9LX-14-06C.....	E-6	1Y42X-6-025.....	E-17, E-26
1C9LX-16-04.....	E-6	1Y42X-6-03.....	E-17, E-26, F-3
1C9LX-16-05C.....	E-6	1Y42X-6-05.....	E-17, E-26, E-30, E-34, F-3, F-6, F-9
1C9LX-16-08.....	D-39, E-6	1Y42X-9-03.....	E-17, E-26, F-3
1C9LX-16-08C.....	D-23, E-6	1Y42X-9-05.....	E-17, E-26, E-30, E-34, F-3, F-6, F-9
1C9LX-25-12.....	E-6	1Y4CX-9-08W.....	E-23
1C9LX-25-12C.....	E-6	1Y9LX-4-03.....	E-9
1C9LX-30-16.....	E-6	1Y9LX-8-08.....	E-9
1C9NX-38-20.....	D-9, D-39	1YA5X-1-03.....	E-20
1C9TX-16-025W.....	C-5	1YA5X-3-03.....	E-20
1C9TX-16-02W.....	C-5	1YA5X-6-05.....	E-20
1C9TX-16-03W.....	C-5	1YALX-1-025.....	E-8
1C9TX-16-04W.....	C-5	1YALX-1-03.....	E-8
1C9TX-16-05W.....	C-5	1YALX-3-025.....	E-8
1D28X-14-06.....	D-11	1YALX-3-03.....	E-8
1D28X-16-08.....	D-11	1YALX-3-04.....	E-8
1D98X-4-4.....	D-27, D-37, D-47	1YALX-6-03.....	E-8
1D98X-6-05.....	D-37	1YALX-6-04.....	E-8
1D9BS-4-04.....	D-43	1YALX-6-05.....	E-8
1D9EH-12-12.....	B-3, B-7	1YBTX-2-025W.....	C-9
1D9EH-16-16.....	B-3, B-7	1YBTX-2-03W.....	C-9
1D9EH-20-20.....	B-3, B-7	1YBTX-2-04W.....	C-9
1D9EH-8-08.....	B-3, B-7	1YBTX-4-025W.....	C-9
1D9LX-4-03.....	E-10	1YBTX-4-03W.....	C-9
1D9LX-4-04.....	E-10	1YBTX-4-04W.....	C-9
1MB8X-6-04.....	D-48	1YBTX-4-05W.....	C-9
1MRLX-6-03.....	E-11	1YBTX-6-05W.....	C-9
1MRLX-8-03.....	E-11	1YM2X-6-03.....	E-17, E-26, F-3
1TM2X-8-03-HPK.....	G-3	1YM2X-6-05.....	E-17, E-26, E-30, E-34, F-3, F-6, F-9
1TM2X-8-05-HPK.....	G-3	1YMJX-11-08W.....	E-17
1U08X-4-04.....	D-26, D-38, D-50	1YMJX-12-08W.....	E-17

Part number	page	Part number	page
1YMLX-11-08	E-8	2440D-025V32	E-4
1YMLX-6-05	E-8	2440D-025V32-TC	E-5
1YZTX-1-025W	C-8	2440D-02V32	E-4
1YZTX-1-02WS	C-8	2440D-03V32	E-4
1YZTX-2-025W	C-8	2440D-03V32-TC	E-5
1YZTX-2-02W	C-8	2440D-04V32	E-4
1YZTX-2-03W	C-8	2440D-04V32-TC	E-5
1YZTX-4-025W	C-8	2440D-05V32	E-4
1YZTX-4-03W	C-8	2440D-05V32-TC	E-5
1YZTX-5-025W	C-8	2440N-06V30	E-4
1YZTX-5-04W	C-8	2440N-08V30	E-4
1YZTX-5-05W	C-8	2440N-12V30	E-4
2022N-04V15-10K	D-20	2440N-16V30	E-4
2022N-04V15-5K	D-20	2580N-06V10-MSHA	D-53
2022N-06V15-10K	D-20	2580N-06V12	D-52
2022N-06V15-5K	D-20	2580N-08V10-MSHA	D-53
2022N-08V15-10K	D-20	2580N-08V12	D-52
2022N-08V15-5K	D-20	2580N-12V12	D-52
216-200-18	I-2	2640D-025V32	E-15
220-200-22	I-2	2640D-03V32	E-15
2240D-025V32	C-2	2640D-05V32	E-15
2240D-025V32-TC	C-3	2640N-08V32	E-15
2240D-02V32	C-2	2640N-12V32	E-15
2240D-02V32-TC	C-3	2640N-16V32	E-15
2240D-03V32	C-2	2648N-08V32	E-22
2240D-03V32-TC	C-3	2648N-12V32	E-22
2240D-04V32	C-2	2648N-16V32	E-22
2240D-04V32-TC	C-3	2740D-025V16	E-25
2240D-05V32	C-2	2740D-03V34	E-25
2240D-05V32-TC	C-3	2740D-05V34	E-25
2244N-025V00	D-5	2740D-08V30	E-25
2244N-06V00	D-5	2741D-05V34/10	E-29
2244N-06V10W	D-5	2748D-05V34	E-32, E-33
2244N-08V10	D-5	2840D-03V34	F-2
2244N-08V10W	D-5	2840D-05V36	F-2
2244N-20V30	D-5	2840D-08V30	F-2
2340N-04V10	D-24	2841D-05V36/17	F-5
2380M-04V30W	D-31	2848D-05V34	F-8
2380M-05V30W	D-31	2849D-05V34	F-11
2380N-025V10	D-31	292EJ-12-12	B-8
2380N-04V00W	D-31	292EJ-16-16	B-8
2380N-04V10-MSHA	D-32	292EJ-20-20	B-8
2380N-05V00	D-31	292EJ-8-08	B-8
2380N-05V00W	D-31	292NC-12-12	B-4
2380N-06V10	D-31	292NC-16-16	B-4
2380N-08V10	D-31	292NC-20-20	B-4
2380N-20V30	D-31	292NC-8-08	B-4
2388N-04V00	D-40	2D9EJ-12-12	B-8
2388N-04V12W	D-40	2D9EJ-16-16	B-8
2388N-08V12W	D-40	2D9EJ-20-20	B-8

Part number	page	Part number	page
2D9EJ-8-08	B-8	6HYLX-4-0-PL-LH	E-13
2D9NC-12-12	B-4	6HYLX-4-02-PL	E-13
2D9NC-16-16	B-4	6HYLX-4-2AC-PL	E-13
2D9NC-20-20	B-4	6HYLX-4-2AC-PL-LH	E-13
2D9NC-8-08	B-4	6HYLX-4-3C-PL	E-13
508-J-500-10	I-2	6HYLX-4-3C-PL-LH	E-13
510-A-500-12	I-2	6HYLX-6-3C-PL	E-13
520-A-500-26	I-2	6HYLX-6-4C-PL	E-13
6018X-2-2A	D-7	6HYLX-6-4C-PL-LH	E-13
6018X-2-2AC	D-7	6HYLX-9-5C-PL	E-13
6018X-4-2AC	D-7	6HYLX-9-5C-PL-LH	E-13
601LX-12-12C	E-11	6HYPL-1-2	C-7
601LX-16-12C	E-11	6Y25X-12-8C	E-18
601LX-16-16C	E-11	6Y25X-16-12C	E-18
601LX-2-2AC	E-11	6Y25X-9-8C	E-18
601LX-2-4	E-11	6Y2LX-12-5C	E-14
601LX-4-3	E-11	6Y2LX-12-8C	E-14
601LX-4-4	E-11	6Y2LX-16-12C	E-14
601LX-4-4C	E-11	6Y2LX-9-5C	E-14
601LX-4-5	D-35, E-11	6Y2LX-9-6C	E-14
601LX-4-5C	D-35, E-11	6Y2LX-9-8C	E-14
601LX-6-5	D-35, E-11	6Y4HX-16-8C	E-26
601LX-6-5C	D-35, E-11	6Y4WX-16-8C	F-3
601LX-8-8	E-11	6Y4WX-9-5C-55	F-12
601LX-8-8C	E-11	6YHLX-4-02-PL	E-12
602PL-1-2A	C-6	6YHLX-4-02-PL-LH	E-12
602PL-2-3	C-6	6YHLX-4-2AC-PL	E-12
602PL-4-4	C-6	6YHLX-4-2AC-PL-LH	E-12
6068X-4-2AC	D-14	6YHLX-4-3C-PL	E-12
6068X-8-8C	D-14	6YHLX-4-3C-PL-LH	E-12
606LX-8-5C	D-36	6YHLX-6-3C-PL	E-12
612-400-14	I-2	6YHLX-6-3C-PL-LH	E-12
620-100-18	I-2	6YHLX-6-4C-PL	E-12
63ZPL-5-2A	C-7	6YHLX-6-4C-PL-LH	E-12
63ZPL-5-3	C-7	6YHLX-9-5C-PL	E-12
63ZPL-5-3C	C-7	6YHLX-9-5C-PL-LH	E-12
63ZPL-5-4C	C-7	6YMHX-11-8C	E-26
65Y8X-6-4	D-43	6YMHX-12-8C	E-26
65YLY-6-3	E-14	6YMWX-11-8C	F-3
65YLY-6-4	E-14	6YMWX-12-8C	F-3
65YLY-6-4C	E-14	6YMWX-6-5C-55	F-12
66YLY-4-3	E-13	6ZELX-5-3C	E-14
66YLY-4-3C	E-13	6ZEPL-5-2A	C-7
6AY8X-6-2AC	D-7	C09-125-1680	H-15
6AYLY-16-16C	E-7	C10-115-1202	H-10
6AYLY-6-2AC	E-7	C10-115-1222	H-10
6AYWX-10-5C-55	F-13	C10-115-1401	H-10
6C9LX-30-16C	E-6	C10-115-1402	H-10
6EZPL-1-2A	C-8	C10-115-1404	H-10
6EZPL-5-2A	C-8	C10-115-1422	H-10

Part number	page	Part number	page
C10-115-1452	H-10	HP006-0-NMD	H-3
C10-115-1454	H-10	HP006-0-X13	H-3
C10-115-6202	H-11	HP006-1-A12	H-4
C10-115-6204	H-11	HP006-1-A9	H-4
C10-115-6401	H-11	HP006-1-HM4	H-4
C10-115-6402	H-11	HP006-1-LM6	H-4
C10-115-6404	H-11	HP006-1-LM9	H-4
C10-115-6452	H-11	HP006-1-NMB	H-4
C10-115-6454	H-11	HP006-1-NMC	H-4
C10-116-1202	H-12	HP006-1-NMD	H-4
C10-116-1222	H-12	HP006-1-X13	H-4
C10-116-1402	H-12	HP006-2-A12	H-5
C10-116-1422	H-12	HP006-2-A9	H-5
C10-116-5202	H-13	HP006-2-HM4	H-5
C10-116-6202	H-13	HP006-2-LM6	H-5
C10-116-6402	H-13	HP006-2-NFB	H-5
C10-125-1202	H-13, H-17	HP006-2-NFC	H-5
C10-125-5202	H-14	HP006-2-NMB	H-5
C10-125-6202	H-14	HP006-2-NMC	H-5
C19-950-0029	H-15	HP006-2-NMD	H-5
C19-950-0062	H-15	HP006-2-X13	H-5
C19-950-0064	H-15	HP010-0-A12	H-6
C19-950-1600	H-15	HP010-0-A16	H-6
C19-950-1601	H-15	HP010-0-LM12	H-6
C19-950-1602	H-15	HP010-0-NFD	H-6
C19-950-1622	H-15	HP010-0-NMD	H-6
C19-950-1623	H-15	HP010-0-X23	H-6
C19-950-1680	H-15	HP010-1-A12	H-7
ESH-08	B-2	HP010-1-A16	H-7
ESH-12	B-2	HP010-1-LM12	H-7
ESH-16	B-2	HP010-1-LM9	H-7
ESH-20	B-2	HP010-1-NMD	H-7
ESH250-08	B-5	HP010-1-X23	H-7
ESH250-12	B-5	HP010-2-A12	H-8
ESH250-16	B-5	HP010-2-A16	H-8
ESH250-20	B-5	HP010-2-NFD	H-8
ESH250Plus-08	B-6	HP010-2-NMD	H-8
ESH250Plus-12	B-6	HP010-2-X23	H-8
ESH250Plus-16	B-6	HPK-HS-8	G-3
ESH250Plus-20	B-6	HPK-HSP-8	G-3
HAHM4BM4	H-15	HS-03	I-4
HP006-0-A12	H-3	HS-05	I-4
HP006-0-A9	H-3	HS-08	I-4
HP006-0-HM4	H-3	HS-12	I-4
HP006-0-HM9	H-3	HS-16	I-4
HP006-0-LM6	H-3	KL-03	I-4
HP006-0-NFB	H-3	KL-05	I-4
HP006-0-NFC	H-3	KL-08	I-4
HP006-0-NMB	H-3	KL-12	I-4
HP006-0-NMC	H-3	KL-16	I-4

Index of part nos

Index

Part number	page	Part number	page
MHDC010	I-2		
MHDC011	I-2		
MHDC012	I-2		
MHDC014	I-2		
MHDC016	I-2		
MHDC018	I-2		
MHDC020	I-2		
MHDC022	I-2		
MHDC024	I-2		
MHDC026	I-2		
MHDC032	I-2		
MK022-03-038	I-3		
MK022-03-039	I-3		
MK022-03-041	I-3		
MK022-03-042	I-3		
MK022-03-043	I-3		
MK022-03-045	I-3		
MSG060	I-3		
MSG1006	I-3		
MSG2006	I-3		
MSG2106	I-3		
MSG4113	I-3		
MSG4120	I-3		
MSG4125	I-3		
MSG6020	I-3		
PVC-S-03	I-4		
PVC-S-05	I-4		
PVC-S-08	I-4		
PVC-S-12	I-4		
PVC-S-16	I-4		
TFTF-8-8	G-3		
TMCAP-8	G-3		
UHPLABEL	I-4		
Y6TF-6-8	G-3		
Y6TF-9-8	G-3		
YTTF-10-8	G-3		
YTTF-6-8	G-3		
YTTF-9-8	G-3		

Part number	page	Part number	page

Parker's Motion & Control Technologies

At Parker, we're guided by a relentless drive to help our customers become more productive and achieve higher levels of profitability by engineering the best systems for their requirements. It means looking at customer applications from many angles to find new ways to create value. Whatever the motion and control technology need, Parker has the experience, breadth of product and global reach to consistently deliver. No company knows more about motion and control technology than Parker. For further info call 0800 27 27 5374



AEROSPACE

Key Markets

- Aircraft engines
- Business & general aviation
- Commercial transports
- Military aircraft
- Missiles & launch vehicles
- Regional transports
- Unmanned aerial vehicles

Key Products

- Flight control systems & components
- Fluid conveyance systems
- Fluid metering delivery & automation devices
- Fuel systems & components
- Hydraulic systems & components
- Inert nitrogen generating systems
- Pneumatic systems & components
- Wheels & brakes



CLIMATE CONTROL

Key Markets

- Agriculture
- Air conditioning
- Life science & dairy
- Life & medical sciences
- Precision cooling
- Processing
- Transportation

Key Products

- CO₂ controls
- Electronic controllers
- Filter driers
- Hand shut-off valves
- Hoses & fittings
- Pressure regulating valves
- Refrigerant distributors
- Safety relief valves
- Solenoid valves
- Thermoelastic expansion valves



ELECTROMECHANICAL

Key Markets

- Aerospace
- Factory automation
- Life science & medical
- Machine tools
- Packaging machinery
- Paper machinery
- Plastics machinery & converting
- Primary metals
- Semiconductor & electronics
- Textile
- Wire & cable

Key Products

- A/C/D/C drives & systems
- Electric actuators, gantry robots & slides
- Electrohydraulic actuation systems
- Electromechanical actuation systems
- Human machine interface
- Linear motors
- Stepper motors, servo motors, drives & controls
- Structural extensions



FLUID & GAS HANDLING

Key Markets

- Aerospace
- Agriculture
- Analytical handling
- Construction machinery
- Food & beverage
- Fuel & gas delivery
- Industrial machinery
- Mobile
- Oil & gas
- Transportation
- Welding

Key Products

- Brass fittings & valves
- Diagnostic equipment
- Fluid conveyance systems
- Industrial hoses
- PTFE & PPA hoses, tubing & plastic fittings
- Rubber & thermoplastic hose & couplings
- Tube fittings & adapters
- Quick disconnects



FILTRATION

Key Markets

- Food & beverage
- Industrial machinery
- Life sciences
- Machine tools
- Medical equipment
- Oil & gas delivery
- Power generation
- Process
- Transportation

Key Products

- Analytical gas generators
- Compressed air & gas filters
- Condition monitoring
- Engine air, fuel & oil filtration & systems
- Hydraulic, lubrication & coolant filters
- Process, chemical, water & microfiltration filters
- Nitrogen, hydrogen & zero air generators



HYDRAULICS

Key Markets

- Aerospace
- Aerial lift
- Agriculture
- Construction machinery
- Forestry
- Industrial machinery
- Mining
- Oil & gas
- Power generation & energy
- Truck/hydraulics

Key Products

- Diagnostic equipment
- Hydraulic cylinders
- Accumulators
- Hydraulic motors & pumps
- Hydraulic systems
- Hydraulic valves & controls
- Power take-offs
- Rubber & thermoplastic hose
- Tube fittings & adapters
- Quick disconnects



SEALING & SHIELDING

Key Markets

- Aerospace
- Chemical processing
- Consumer
- Energy, oil & gas
- Fluid power
- General industrial
- Information technology
- Life sciences
- Military
- Semiconductor
- Telecommunications
- Transportation

Key Products

- Dynamic seals
- Elastomeric O-rings
- EMI shielding
- Extruded & precision-cut, fabricated elastomeric seals
- Homogeneous & inserted elastomeric seals
- High temperature metal seals
- Metal & plastic retained composite seals
- Thermal management



PNEUMATICS

Key Markets

- Aerospace
- Conveyor & material handling
- Factory automation
- Life science & medical
- Machine tools
- Packaging machinery
- Transportation & automotive

Key Products

- Air regulation
- Brass fittings & valves
- Manifolds
- Pneumatic accessories
- Pneumatic actuators & grippers
- Pneumatic valves & controls
- Quick disconnects
- Rotary actuators
- Rubber & thermoplastic hose & couplings
- Structural extensions
- Thermoelastic tubing & fittings
- Vacuum generators, cups & sensors



PROCESS CONTROL

Key Markets

- Chemical & refining
- Food, beverage & dairy
- Medical & dental
- Microelectronics
- Oil & gas
- Power generation

Key Products

- Analytical sample conditioning products & systems
- Biopolymer chemical delivery
- Filtration, valves & pumps
- High purity gas delivery fittings, valves & regulators
- Instrumentation fittings, valves & regulators
- Medium pressure fittings & valves
- Process control manifolds



ENGINEERING YOUR SUCCESS.

Parker Worldwide

Europe, Middle East, Africa

AE – United Arab Emirates,
Dubai
Tel: +971 4 8127100
parker.me@parker.com

AT – Austria, Wiener Neustadt
Tel: +43 (0)2622 23501-0
parker.austria@parker.com

AT – Eastern Europe, Wiener
Neustadt
Tel: +43 (0)2622 23501 900
parker.easteurope@parker.com

AZ – Azerbaijan, Baku
Tel: +994 50 2233 458
parker.azerbaijan@parker.com

BE/LU – Belgium, Nivelles
Tel: +32 (0)67 280 900
parker.belgium@parker.com

BY – Belarus, Minsk
Tel: +375 17 209 9399
parker.belarus@parker.com

CH – Switzerland, Etoy
Tel: +41 (0)21 821 87 00
parker.switzerland@parker.com

CZ – Czech Republic, Klecany
Tel: +420 284 083 111
parker.czechrepublic@parker.com

DE – Germany, Kaarst
Tel: +49 (0)2131 4016 0
parker.germany@parker.com

DK – Denmark, Ballerup
Tel: +45 43 56 04 00
parker.denmark@parker.com

ES – Spain, Madrid
Tel: +34 902 330 001
parker.spain@parker.com

FI – Finland, Vantaa
Tel: +358 (0)20 753 2500
parker.finland@parker.com

FR – France, Contamine s/Arve
Tel: +33 (0)4 50 25 80 05
parker.france@parker.com

GR – Greece, Athens
Tel: +30 210 933 6450
parker.greece@parker.com

HU – Hungary, Budapest
Tel: +36 1 220 4155
parker.hungary@parker.com

IE – Ireland, Dublin
Tel: +353 (0)1 466 6370
parker.ireland@parker.com

IT – Italy, Corsico (MI)
Tel: +39 02 45 19 21
parker.italy@parker.com

KZ – Kazakhstan, Almaty
Tel: +7 7272 505 800
parker.easteurope@parker.com

NL – The Netherlands, Oldenzaal
Tel: +31 (0)541 585 000
parker.nl@parker.com

NO – Norway, Asker
Tel: +47 66 75 34 00
parker.norway@parker.com

PL – Poland, Warsaw
Tel: +48 (0)22 573 24 00
parker.poland@parker.com

PT – Portugal, Leca da Palmeira
Tel: +351 22 999 7360
parker.portugal@parker.com

RO – Romania, Bucharest
Tel: +40 21 252 1382
parker.romania@parker.com

RU – Russia, Moscow
Tel: +7 495 645-2156
parker.russia@parker.com

SE – Sweden, Spånga
Tel: +46 (0)8 59 79 50 00
parker.sweden@parker.com

SK – Slovakia, Banská Bystrica
Tel: +421 484 162 252
parker.slovakia@parker.com

SL – Slovenia, Novo Mesto
Tel: +386 7 337 6650
parker.slovenia@parker.com

TR – Turkey, Istanbul
Tel: +90 216 4997081
parker.turkey@parker.com

UA – Ukraine, Kiev
Tel: +380 44 494 2731
parker.ukraine@parker.com

UK – United Kingdom, Warwick
Tel: +44 (0)1926 317 878
parker.uk@parker.com

ZA – South Africa, Kempton Park
Tel: +27 (0)11 961 0700
parker.southafrica@parker.com

North America

CA – Canada, Milton, Ontario
Tel: +1 905 693 3000

US – USA, Cleveland
Tel: +1 216 896 3000

Asia Pacific

AU – Australia, Castle Hill
Tel: +61 (0)2-9634 7777

CN – China, Shanghai
Tel: +86 21 2899 5000

HK – Hong Kong
Tel: +852 2428 8008

IN – India, Mumbai
Tel: +91 22 6513 7081-85

JP – Japan, Tokyo
Tel: +81 (0)3 6408 3901

KR – South Korea, Seoul
Tel: +82 2 559 0400

MY – Malaysia, Shah Alam
Tel: +60 3 7849 0800

NZ – New Zealand, Mt Wellington
Tel: +64 9 574 1744

SG – Singapore
Tel: +65 6887 6300

TH – Thailand, Bangkok
Tel: +662 717 8140

TW – Taiwan, Taipei
Tel: +886 2 2298 8987

South America

AR – Argentina, Buenos Aires
Tel: +54 3327 44 4129

BR – Brazil, Sao Jose dos Campos
Tel: +55 12 4009 3500

CL – Chile, Santiago
Tel: +56 2 623 1216

MX – Mexico, Apodaca
Tel: +52 81 8156 6000

VE – Venezuela, Caracas
Tel: +58 212 238 5422

Ed. 07/09-09